



Escola d'Enginyeria de Telecomunicació i
Aeroespacial de Castelldefels

UNIVERSITAT POLITÈCNICA DE CATALUNYA

BACHELOR'S THESIS

Title: Preliminary study and design of the avionics system for an eVTOL aircraft

Bachelor's Degree: Aerospace Systems Engineering and Network Engineering

Author: Toni Tur García

Directors: Fernando Mellibovsky, José Manuel Yúfera, Jaume Suriaca and Antti Perttula

Supervisor: Fernando Mellibovsky and Jaume Suriaca

Date: September 2nd, 2022

ACKNOWLEDGEMENTS

This endeavor would not have been possible without the help and patience of my tutor Jaume Suriaca. I also could not have undertaken this journey without my professors Fernando Mellibovsky and José Manuel Yúfera, who generously provided knowledge and expertise with great feedback.

Additionally, I would like to express my deepest appreciation to Doctor Antti Perttula, for his support during my Erasmus period in Tampere, Finland.

I would like to extend my sincere thanks to my classmates, who have walked with me during these five years at university, for their editing help, feedback, and moral support.

Lastly, I would be remiss in not mentioning my family, especially my parents and sister. Their belief in me has kept my motivation and spirits high during this process. I would also like to thank all my friends from my Erasmus experience, my friends from Barcelona (basketball, high school, and university), and the ones from my home, Ibiza.

Resum

El projecte consisteix en l'estudi, creació, implementació i desenvolupament del sistema d'aviònica d'un avió elèctric d'enlairament i aterratge vertical (eVTOL) per a un projecte en curs de l'empresa ONAEROSPACE.

L'avió està pensat per a 7 passatgers i 1 pilot, amb una autonomia màxima de més de 1000 km. El fuselatge estarà format per un compost de fibra de carboni per reduir el pes i utilitzarà motors elèctrics alimentats per bateries.

El sistema d'aviònica proporcionarà a l'aeronau sistemes de comunicació i navegació, un sistema d'enlairament (T/O) i aterratge autònom, així com el desenvolupament de sistemes de gestió de la cabina.

Aquest document està dividit en dues parts. La primera part comença amb l'estudi de totes les eines necessàries per als sistemes de comunicació i navegació. És a dir, totes les antenes i sensors obligatoris per obtenir informació sobre l'entorn (temps, obstacles, altres avions...). En aquesta primera part també s'estudia la xarxa de comunicació interna per enviar dades d'aquests sensors i antenes als principals sistemes de gestió de vol.

La segona part del projecte està dedicada als sistemes de cabina de pilotatge i l'estudi per al desenvolupament futur de sistemes autònoms. La cabina tindrà una cabina de vidre complet, amb pantalles tàctils i un assistent de veu intel·ligent. Serà molt ergonòmic i senzill, amb molt d'espai a la cabina.

Per tal de tenir una idea del cost de la implantació de tots els sistemes per a l'aeronau, al final de cada apartat es fa una anàlisi d'estimació de pes i costos.

L'última part del projecte consisteix en l'estudi del disseny d'un assistent de veu intel·ligent virtual i la implantació de sistemes autònoms.

Avui en dia, l'assistent de veu intel·ligent virtual és un sistema d'intel·ligència artificial que funciona com un sistema de monitoratge pilot que ajuda el pilot per reduir la càrrega de treball del pilot. La idea futura és que el pilot podria dir ordres a l'assistent de veu i no fer res amb les mans, només controlar que tot funcioni correctament.

Pel que fa al sistema autònom, la conclusió és que amb la tecnologia existent avui no és possible. No obstant això, en el futur, quan sigui possible avions totalment autònoms, la idea és que tot i ser totalment autònom, el pilot pugui prendre el control de l'avió en qualsevol moment.

Resumen

El proyecto consiste en el estudio, creación, implementación y desarrollo del sistema de aviónica de un avión eléctrico de despegue y aterrizaje vertical (eVTOL) para un proyecto en curso de la empresa ONAEROSPACE.

El avión está diseñado para 7 pasajeros y 1 piloto, con un alcance máximo de más de 1000 km. El fuselaje estará formado por un compuesto de fibra de carbono para reducir el peso y utilizará motores eléctricos alimentados por baterías.

El sistema de aviónica dotará a la aeronave de sistemas de comunicación y navegación, un sistema autónomo de despegue (T/O) y aterrizaje, así como el desarrollo de sistemas de gestión de cabina.

Este documento se divide en dos partes. La primera parte comienza con el estudio de todas las herramientas necesarias para los sistemas de comunicación y navegación. Eso significa todas las antenas y sensores obligatorios para obtener información sobre el entorno (clima, obstáculos, otros aviones...). En esta primera parte también se estudia la red de comunicación interna para enviar datos desde estos sensores y antenas a los principales sistemas de gestión de vuelo.

La segunda parte del proyecto está dedicada a los sistemas de cabina y al estudio para el desarrollo futuro de sistemas autónomos. La cabina será completamente acristalada, con pantallas táctiles y un asistente de voz inteligente. Será muy ergonómico y sencillo, con mucho espacio en la cabina.

Para tener una idea del costo de implementación de todos los sistemas para la aeronave, al final de cada sección se realiza un análisis de estimación de peso y costo.

La última parte del proyecto consiste en el estudio del diseño de un asistente virtual de voz inteligente y la implementación de sistemas autónomos.

Hoy en día, el asistente de voz inteligente virtual es un sistema de inteligencia artificial que funciona como un sistema de monitoreo de pilotos que asiste al piloto para disminuir la carga de trabajo del piloto. La idea futura es que el piloto pueda dar órdenes al asistente de voz y no hacer nada con las manos, solo controlar que todo está bien.

En cuanto al sistema autónomo, la conclusión es que con la tecnología existente hoy no es posible. No obstante, en el futuro, cuando sean posibles aeronaves totalmente autónomas, la idea es que aunque sea totalmente autónomo, el piloto pueda tomar el control de la aeronave en cualquier momento.

Overview

The project consists of the study, creation, implementation, and development of the avionics system of an electric Vertical Take-Off and Landing (eVTOL) airplane for an ongoing project from the company ONAEROSPACE.

The plane is intended to be for 7 passengers and 1 pilot, with a maximum range of 1000+ km. The fuselage will be formed of carbon fiber composite to reduce weight and it will use electric motors powered by batteries.

The avionics system will provide the aircraft with communication and navigation systems, an autonomous Take-Off (T/O) and landing system, as well as the development of cockpit management systems.

This document is divided into two parts. The first part begins with the study of all the necessary tools for communication and navigation systems. That means all compulsory antennas and sensors to obtain information about the surroundings (weather, obstacles, other planes...). The intern communication network to send data from these sensors and antennas to main flight management systems is also studied in this first part.

The second part of the project is dedicated to cabin cockpit systems and the study for the future development of autonomous systems. The cabin will have a full-glass cockpit, with touchable screens and an intelligent voice assistant. It will be very ergonomic and simple, with a lot of space in the cabin.

In order to have an idea of the cost of the implementation of all the systems for the aircraft, a weight and cost estimation analysis are done at the end of each section.

The last part of the project consists of the study of the design of a virtual intelligent voice assistant and the implementation of autonomous systems.

Nowadays, the virtual intelligent voice assistant is an artificial intelligence system that works as a pilot monitoring system which assists the pilot in order to decrease the pilot's workload. The future idea is that the pilot could tell commands to the voice assistant and do nothing with the hands, just control that everything works correctly.

Regarding the autonomous system, the conclusion is that with the existent technology is not possible today. Nevertheless, in the future, when fully autonomous aircraft are possible, the idea is that although being fully autonomous, the pilot can take the control of the aircraft at any moment.

INDEX

CHAPTER 0. INTRODUCTION.....	23
0.1 OBJECTIVES	23
0.2 STRUCTURE	24
0.3 TIMELINE.....	24
CHAPTER 1. GENERAL AVIONICS SYSTEMS STUDY.....	26
1.1 Introduction	26
1.2 General Avionics Systems	26
1.2.1 Communications Systems	27
1.2.2 Navigation Systems	28
1.2.3 Monitoring Systems	29
1.2.4 Aircraft Flight Control Systems	29
1.2.5 Fuel Systems	31
1.2.6 Collision Avoidance Systems.....	32
1.2.7 Flight Data Recorder Systems	33
1.2.8 Weather Radar Systems.....	33
1.2.9 Flight Management Systems.....	34
1.3 Innovative Avionics Systems	35
1.3.1 Voice Assistant (ONA)	35
CHAPTER 2. DESIGN OF THE COMMUNICATION AND NAVIGATION SYSTEMS	38
2.1 Antennas.....	38
2.1.1 Main Antenna Types	39
2.1.1.1 Dipole Antennas.....	39
2.1.1.2 Monopole Antenna (Marconi Antenna)	39
2.1.1.3 Patch Antenna	40
2.1.1.4 Slot Antenna	40
2.1.1.5 Loop Antenna.....	41
2.1.2 Required Antennas	42
2.1.2.1 Navigation & Surveillance Services	42
2.1.2.1.1 ADF/Non-Directional Beacon (NDB)	42
2.1.2.1.2 DME.....	43
2.1.2.1.3 Radio Altimeters	44
2.1.2.1.4 Emergency Locator Transmitter (ELT)	45
2.1.2.1.5 GPS	45
2.1.2.1.6 ATC Transponder.....	47
2.1.2.1.7 TCAS.....	47
2.1.2.1.8 ILS.....	49
2.1.2.1.9 Marker Beacons	51
2.1.2.1.10 VOR	52
2.1.2.1.11 Weather Radar	53
2.1.2.2 Communication services.....	54
2.1.2.2.1 VHF Voice Communications.....	54
2.1.2.2.2 HF Voice Communications	55
2.1.3 Weight & Cost Estimation	56
2.2 Sensors	57
2.2.1 Flow Sensors	59
2.2.1.1 Pitot Tube.....	59
2.2.1.2 Flow Meter at Hydraulic System	60
2.2.2 Liquid Level Sensors	60
2.2.3 Pressure Sensors	61
2.2.4 Position Sensors	62
2.2.5 Temperature Sensors.....	63

2.2.6	Force, Vibration & Torque Sensors	64
2.2.7	Instrument and Operational Sensors	65
2.2.7.1	<i>Altimeter</i>	65
2.2.7.1.1	Barometric Altimeters	65
2.2.7.1.2	Radio Altimeters	66
2.2.7.1.3	GNSS	66
2.2.7.1.4	Laser Altimeter	66
2.2.7.1.5	Use of altimeters in aviation	66
2.2.7.2	<i>Airspeed Indicators</i>	68
2.2.7.3	<i>Vertical Speed Indicator (VSI)</i>	68
2.2.7.4	<i>Compasses and Magnetometers</i>	68
2.2.7.5	<i>Attitude Heading & Reference Systems (AHRS)</i>	69
2.2.7.6	<i>Angle of Attack (AOA)</i>	70
2.2.7.7	<i>Humidity Sensor</i>	70
2.2.7.8	<i>Fatigue Meter Sensor</i>	70
2.2.8	Proximity Sensors	71
2.2.9	Other Sensors	72
2.2.9.1	<i>Collision Avoidance</i>	72
2.2.9.1.1	Optical Cameras	73
2.2.9.1.2	LIDAR System	73
2.2.9.1.3	RADAR	74
2.2.9.1.4	Autoland, feature of the Garmin G3000 flight deck	74
2.2.9.2	<i>De-Icing Sensors</i>	75
2.2.9.3	<i>Sound Sensors</i>	75
2.2.10	Weight & Cost Estimation	76
2.3	Internal Communications Network System	76
2.3.1	Flight Management System (FMS)	76
2.3.1.1	<i>Engine Indicating & Crew Alerting System (EICAS)</i>	77
2.3.1.2	<i>Air Data Computer (ADC)</i>	78
2.3.1.3	<i>Electronic Flight Instrument System (EFIS)</i>	79
2.3.1.4	<i>Automatic Flight Control System (AFCS)</i>	79
2.3.1.5	<i>Aircraft Health Monitoring System (AHMS)</i>	80
2.3.1.6	<i>Inertial Reference System (IRS)</i>	80
2.3.1.7	<i>Collision Avoidance Systems (CAS)</i>	80
2.3.1.8	<i>Fly-by-Wire Digital Flight Control System (DFCS)</i>	81
2.3.1.9	<i>Ground Proximity Warning System (GPWS)</i>	81
2.3.2	Communications Network	81
2.3.2.1	<i>CAN Bus</i>	82
2.3.2.1.1	CAN Working Principle	82
2.3.2.1.2	CAN Main Characteristics	82
2.3.2.1.3	CAN Limitations	83
2.3.2.2	<i>ARINC 664 Part 7 Bus</i>	84
2.3.2.2.1	ARINC 664 Working principle	84
2.3.2.2.2	ARINC 664 Main Characteristics	85
2.3.2.2.3	ARINC 664 Limitations	86
2.3.2.2.4	CAN bus VS ARINC 664 bus	86
2.3.2.3	<i>Optical Fiber</i>	87
2.3.2.4	<i>Technology 5G</i>	88
2.3.2.5	<i>Technology Selection</i>	90
2.3.3	Cost Estimation	90
CHAPTER 3. COCKPIT DESIGN FOR SINGLE-PILOT INSTRUMENTAL FLIGHT RULES (SPIFR)		92
3.1. INTRODUCTION		92
3.2 SINGLE-PILOT IFR		92
3.2.1	Legal Requirements	92
3.2.2	Design Requirements for the eVTOL	93
3.2.2.1	<i>Required Cockpit Systems</i>	93
3.2.2.1.1	High-Quality Navigation & Communication Radios	94
3.2.2.1.2	Headset & Push-To-Talk Switch	94
3.2.2.1.3	Autopilot	95
3.2.2.1.4	GPS/DME	95
3.2.2.1.5	Hand-held Communications Radio & Hand-Held GPS	96
3.2.2.1.6	Backup Power for Flight Instruments	96

3.2.2.1.7 Others	96
3.2.2.2 Requirements for SPIFR Operations	97
3.2.2.3 Preparation Before Flight	98
3.2.3 Single-Pilot IFR Existing Aircraft with Garmin Avionics	99
3.2.3.1 Cessna CJ3+ (Citation Jet 3+)	99
3.2.3.2 Phenom 300E (Prodigy Touch G3000)	100
3.2.3.3 HondaJet Elite (HA-420 with G3000)	101
3.2.3.4 Cessna 208B Grand Caravan (G1000)	102
3.2.3.5 Quest Kodiak (G1000)	102
3.2.4 Weight & Cost Estimation	103
3.3. FULL GLASS COCKPIT	104
3.3.1 Glass Cockpit Model	104
3.3.1.1 Glass Cockpit Definition	104
3.3.1.2 Garmin G3000 Integrated Flight Deck	105
3.3.2 Garmin G3000 Main Characteristics	105
3.3.2.1 System Components	105
3.3.2.1.1 System Block Diagram	107
3.3.2.2 Integrated Flight Deck Characteristics	107
3.3.2.2.1 Fingertip Control Meets Integrated Flight Deck	107
3.3.2.2.2 Simple, Powerful & Expandable	108
3.3.2.2.3 A Truly Fully Integrated Flight Deck	108
3.3.2.2.4 Smooth on the Move	108
3.3.2.3 System Specifications	109
3.3.2.3.1 Screens (PFD & MFD)	109
3.3.2.3.2 Touchscreen Controllers (GTC)	110
3.3.2.3.3 Integrated Avionics Unit (IAU)	111
3.3.2.3.4 Autopilot or Flight Control System GFC 700	111
3.3.2.3.5 System Alerts	111
3.3.2.3.5 Connections & Speed	112
3.3.3 Sidestick	113
3.3.3.1 Description	113
3.3.3.2 Advantages VS Disadvantages	113
3.3.3.3 Model – Airbus Sidestick	114
3.3.3.4 Future Side Stick	115
3.4. CABIN COCKPIT DESIGN	115
CHAPTER 4. FUTURE TECHNOLOGY IMPLEMENTATION	119
4.1. INTRODUCTION	119
4.2. VOICE ASSISTANT. DESIGN OF A VIRTUAL INTELLIGENT VOICE ASSISTANT	120
4.2.1 Introduction	120
4.2.2 System Functionality	120
4.2.3 Commands	121
4.2.3.1 Commands Requirements	121
4.2.3.2 Commands Classification	122
4.2.3.3 Commands interpretation process	122
4.2.4 Flight Control	123
4.2.5 Possibility of realization	124
4.2.5.1 Time of System Reaction (TSR)	124
4.2.5.2 Development of Technology	124
4.2.5.3 Limitations	125
4.2.5.3.1 Noise	125
4.2.5.3.2 Vocabulary	125
4.2.5.3.3 Speaker Dependency	126
4.2.5.3.4 Time Response	126
4.2.6 Aviation Voice Assistants Nowadays	126
4.2.1.1 Thales Group	126
4.2.1.2 Honeywell Aerospace	127
4.2.1.3 Rockwell Collins	128
4.2.1.4 Voice Flight Systems	128
4.2.7 Ongoing & Future Scenario	129
4.3. UAV SYSTEM	130

4.3.1 Introduction.....	130
4.3.2 Projects in Development.....	131
4.3.2.1 Liliu Jet.....	131
4.3.2.2 Volocopter VoloCity.....	131
4.3.2.3 eHang 184.....	133
4.3.2.4 CityAirbus NextGen.....	134
CHAPTER 5. CONCLUSIONS.....	137
BIBLIOGRAPHY	140
APPENDICES	156
Appendix A. Sensors Weight & Cost Estimation Table.....	156
Appendix B. G3000 Systems.....	158
Appendix C. System Block Diagram	162

FIGURES INDEX

Figure 1. Simple Dipole [20].....	39
Figure 2. Monopole Antenna [20].....	40
Figure 3. Patch antenna & an array of patch antennas [20]	40
Figure 4. Slot Antenna [20]	41
Figure 5. Loop Antenna [20].....	41
Figure 6. ADF/NDB Antenna, Schematic & S72-1712-10 ADF Antenna [20] ...	42
Figure 7. Location of the ADF/NDB antennas.....	42
Figure 8. DME Antenna model S65-5366-895L [20].....	43
Figure 9. S65-5366-895L Antenna [42] and its location.....	43
Figure 10. Radio Altimeter Antenna [140]	44
Figure 11. Location of the Radio Altimeter antennas	44
Figure 12. S65-1231 ELT Antenna [42].....	45
Figure 13. ELT S65-1231 Antenna [42] and its location	45
Figure 14. GPS Patch Antenna model S67-1575-168 [42].....	46
Figure 15. GPS S67-1575-168 Antenna [42] and its location.....	46
Figure 16. ATC Transponder Antenna model S65-5366-895L [42] and its location	47
Figure 17. TCAS Antenna [20] and TCAS & EHSI Cockpit Display [32]	48
Figure 18. TCAS S72-1735-26 Antenna [42] and its location.....	48
Figure 19. Radio Components of ILS [36]	49
Figure 20. LOC S65-147-7 Antenna & Glide Slope S41422-6 Antenna [42]....	50
Figure 21. Aircraft Nose Components [143].....	50
Figure 22. Marker Beacon Antenna [144].....	51
Figure 23. Marker Beacon S35-1000-1 Antenna [42] and its location.....	52
Figure 24. VOR Antenna [145].....	52
Figure 25. VOR S65-247-33 Antenna [42] and its location.....	53
Figure 26. Weather Radar Antenna [146].....	53
Figure 27. Weather Radar Display Screen [147].....	54
Figure 28. Weather Radar Antenna - Rockwell Collins MultiScan WXR-2100 [148].....	54
Figure 29. VHF Antenna model DM C50-17 [149]	55
Figure 30. Location of VHF antennas.....	55
Figure 31. Aircraft system sensors I [150].....	57
Figure 32. Aircraft system sensors II [151].....	58
Figure 33. Drone sensors I [152]	58
Figure 34. Drone sensors II [153]	58
Figure 35. Pitot Tube beneath the cockpit [154].....	59
Figure 36. Pitot tube from Collins Aerospace [155].....	59
Figure 37. P213 Piston Flow Meter [156]	60
Figure 38. FCI Model AS-LLS [53].....	61
Figure 39. AS-PT sensor [157].....	62
Figure 40. Honeywell Position Sensors (LVDTs, RVDTs + Hall-Effect & Resolver)	63
Figure 41. Honeywell Temperature Sensors [161].....	64
Figure 42. Schema where force sensors should be [162].....	64
Figure 43. Triaxial and Torsion force sensors from PCB Piezotronics &	65
Figure 44. Honeywell Precision Barometer and Altimeter (HPB/HPA) [166] ...	67
Figure 45. DRA-2421 Radio Altimeter from Wavenet [167].....	67
Figure 46. AR3000 Acuity Laser Altimeter [168].....	68

Figure 47. GMU-44 Garmin Magnetometer [169].....	69
Figure 48. GRS-77 Garmin AHRS [170].....	69
Figure 49. The Angle of Attack 0863D1 Sensor [155].....	70
Figure 50. AMETEK Humidity Sensor [171].....	70
Figure 51. AMETEK Fatigue Meter Sensor [172].....	71
Figure 52. GAPS & HAPS Honeywell Proximity Sensors [173, 174].....	72
Figure 53. Characteristics of the most common DAA Technologies:.....	72
Figure 54. CASIA X Computer and Cameras for DAA System [175].....	73
Figure 55. Luminar LIDAR System [176].....	73
Figure 56. Honeywell IntuVue RDR-84K Band RADAR System [75].....	74
Figure 57. Collins Aerospace Ice Detector [69].....	75
Figure 58. FMS Subsystems Structure [77].....	77
Figure 59. Garmin G3000 Glass Cockpit [177].....	78
Figure 60. Garmin GDC-74H Air Data Computer [178].....	78
Figure 61. GFC 700 Garmin Digital AFCS [179].....	79
Figure 62. CAN bus OSI layers and Physical Implementation [88].....	83
Figure 63. OSI Layers AFDX [90].....	86
Figure 64. Bose A20 Aviation Headset [180].....	94
Figure 65. Yaesu FTA750L Hand-Held VHF Transceiver/GPS [109].....	96
Figure 66. Garmin Pilot & ForeFlight App Interfaces, respectively [181, 182] ..	99
Figure 67. CJ3+ Garmin's G3000 Integrated Flight Deck [183].....	100
Figure 68. Embraer's Phenom 300E Prodigy Touch G3000 Integrated Flight Deck [184].....	101
Figure 69. HondaJet Elite HA-420 with G3000 Integrated Flight Deck [185] ..	101
Figure 70. Cessna 208B Grand Caravan G1000 Cockpit [186].....	102
Figure 71. Quest Kodiak G1000NXi Cockpit [187].....	103
Figure 72. Example of what a PFD can show [113].....	109
Figure 73. Example of what an MFD can show [113].....	110
Figure 74. GTCs example of menu & frequency screens [113].....	110
Figure 75. GFC 700 over the MFD in G3000 Integrated Flight Deck [177].....	111
Figure 76. Airbus sidestick [188].....	114
Figure 77. Sidestick and autopilot working principle [188].....	115
Figure 78. Cabin cockpit design from the center behind the seats.....	116
Figure 79. Cabin cockpit design from the left-side.....	116
Figure 80. Cabin cockpit design from the right-side.....	117
Figure 81. The commands interpretation process [118].....	122
Figure 82. Series of three commands, only executed at discrete time moments [118].....	123
Figure 83. SRM integrated with autopilot's system [118].....	124
Figure 84. Final Prototype Lilium Jet [129].....	131
Figure 85. VoloCity Aircraft Model [131].....	132
Figure 86. VoloConnect Aircraft Model [131].....	132
Figure 87. eHang 184 AAV [132].....	133
Figure 88. eHang 216 AAV [133].....	133
Figure 89. Airbus Vahana Demonstrator [136].....	134
Figure 90. CityAirbus Demonstrator [137].....	135
Figure 91. CityAirbus NextGen [138].....	135
Figure 92. System Block Diagram G3000 Integrated Flight Deck [114].....	162

TABLES INDEX

Table 1. Summary of all antennas, prices, and weights	56
Table 2. Comparison between CAN bus and ARINC 664 bus	87
Table 3. Comparison between Optical Fiber and Copper	88
Table 4. Summary of all the FMS with their prices.....	90
Table 5. Summary of some of the cockpit required systems price and weight	104
Table 6. Types of connection buses and their data rates	112
Table 7. Summary of all sensors, prices, and weights.....	157
Table 8. G3000 LRUs description.....	161

NOMENCLATURE

Abbreviation	Meaning
A	
AAV	Autonomous Aerial Vehicle
AC	Alternating Current
ACARS	Aircraft Communications, Addressing & Reporting System
ACAS	Airborne Collision Avoidance System
ADC	Air Data Computer
ADF	Automatic Direction Finder
ADIRS	Air Data Inertial Reference System
ADM	Aeronautical Decision Making
ADN	Aircraft Data Network
AEEC	Airlines Electronic Engineering Committee
AFCS	Automatic Flight Control System
AFDX	Avionics Full-Duplex Switched Ethernet
AGL	Above Ground Level
AHMS	Aircraft Health Monitoring System
AHRS	Attitude Heading & Reference System
AI	Artificial Intelligence
AOA	Angle of Attack
APU	Auxiliary Power Unit
ARINC	Aeronautical Radio INC
ASL	Above Sea Level
ATC	Air Traffic Control
ATIS	Automatic Terminal Information Service
ATN	Aeronautical Telecommunication Network
AWOS	Automated Weather Observation System
B	
BAG	Bandwidth Allocation Gap
C	
CAN	Controller Area Network
CAS	Collision Avoidance Systems
CDU	Control Display Unit
CFIT	Controlled Flight Into Terrain
CL	Coefficient of Lift
CO ₂	Carbon Dioxide
COSPAS-SARSAT	International Satellite System for Search & Rescue
CPU	Central Processing Unit
CSMA/AMP	Carrier Sense Multiple Access with Arbitration based on Message Priority
D	
DA	Destination Address
DAA	Detect & Avoid
DC	Direct Current
DFCS	Digital Flight Control System

DME	Distance Measurement Equipment
E	
EASA	European Union Aviation Safety Agency
ECAM	Electronic Centralized Aircraft Monitoring
ECS	Environmental Control System
ECU	Electronic Control Unit
EFB	Electronic Flight Bag
EFD	Electronic Flight Display
EFIS	Electronic Flight Instrument System
EICAS	Engine Indicating & Crew Alerting System
ELT	Emergency Locator Transmitter
EM	Electro-magnetic
EMBB	Enhanced Mobile Broadband
EMI	Electro-magnetic Interference
EO/IR	Electro-Optic Systems
eVTOL	Electric Vertical Take-Off & Landing
F	
FAA	Federal Aviation Administration
FCMS	Fuel Control & Monitoring System
FCS	Flight Control System
FD	Flight Director
FDR	Flight Data Recorder
FIR	Flight Information Region
FMC	Flight Management Computer
FMCS	Flight Management Computer System
FMS	Flight Management System
FQIS	Fuel Quantity Indication System
ft	Feet
G	
GA	General Aviation
GNSS	Global Navigation Satellite System
GPS	Global Positioning System
GPWS	Ground-Proximity Warning Systems
H	
HF	High Frequency
HIS	Horizontal System Indicator
HPA	Honeywell Precision Altimeter
HPB	Honeywell Precision Barometer
HSDB	High-Speed Data Bus
I	
IAU	Integrated Avionics Unit
IDE	Integrated Development Environment
IFR	Instrumental Flight Rules
ILS	Instrument Landing System
IMC	Instrument Meteorological Conditions

INS	Inertial Navigation System
IoT	Internet of Things
IP	Internet Protocol
IPS	Ice Protection System
IR	Instrument Rating
IRS	Inertial Reference System
ISO	International Standards Organization
K	
Kbps	Kilobits per second
L	
LCD	Liquid Crystal Display
LIDAR	Light Detection & Ranging
LORAN	Long-Range Navigation
LRU	Line Replaceable Unit
LVDTs	Linear Variable Differential Transformers
LW	Long-Wave
M	
m	Meters
MAC	Mid-air Collision
MAC ¹	Medium Access Control
Mbps	Megabits per second
MEMS	Micro-Electro-Mechanical Systems
MFD	Multi-Function Display
MID	Magnetostrictive Ice Detector
MMTC	Massive Machine Type Communication
ms	milliseconds
MTOW	Maximum Take-Off Weight
N	
NAV-COM	Navigational-Communication
NDB	Non-Directional Beacon
O	
OAT	Operational Air Traffic
OID	Optical Ice Detector
ONA	Operational Navigation Aerospace
OSI	Open Systems Interconnection
P	
PCA	Principal Component Analysis
PFD	Primary Flight Display
PVT	Position, Velocity & Time
Q	
QoS	Quality of Service

R

RAIM	Receiver Autonomous Integrity Monitoring
RDF	Radio Direction Finding
RNAV	Area Navigation System
RTD	Resistance Temperature Detectors
RVDTs	Rotary Variable Differential Transformers
Rx	Receiver
R&D	Research and Development

S

SA	Source Address
SATCOM	Satellite Communications
SELCAL	Selective Calling
SESAR	Single European Sky ATM Research
SNR	Signal-to-Noise Ratio
SPAAT	Stall Protection Angle of Attack Transducers
SPIFR	Single-Pilot Instrumental Flight Rules
SPU	Speech Processing Unit
SRM	Speech Recognition Module
SSR	Secondary Surveillance Radar
STP	Shielded Twisted Pair
SWAAT	Stall Warning Angle of Attack Transducers
SWAP	Size, Weight, and Power

T

TACAN	Tactical Air Navigation
TAWS	Terrain Awareness Warning System
Tbps	Terabits per second
TCAS	Traffic Alert & Collision Avoidance System
TFR	Temporary Flight Restriction
THR	Time of Human Reaction
T/O	Take-Off
TPAS	Trajectory Predictor based Aircraft Simulator
TSR	Time of System Reaction
Tx	Transmitter

U

UAM	Urban Air Mobility
UAS	Unmanned Aircraft System
UAV	Unmanned Aerial Vehicle
UDP	User Datagram Protocol
UHF	Ultra-High Frequency
URLLC	Ultra-Reliable Low Latency Communication
UTP	Unshielded Twisted Pair

V

V	Volts
VDL	VHF Data Link
VFR	Visual Flight Rules
VHF	Very High Frequency

VL
VOR
VSP

Virtual Link
VHF Omnidirectional Range
Vertical Speed Indicator

W
W
WAAS
WXGA

Watts
Wide Area Augmentation System
Wide Extended Graphics Array

CHAPTER 0. INTRODUCTION

These last few years, the aviation industry has been releasing around 700 million tons of Carbon Dioxide (CO₂) into the atmosphere per year, which represents a very significant contribution to global warming. Even with the COVID-19 pandemic, the aviation industry still releases around 550 million tons of CO₂.

However, due to the technological advances obtained in electric-powered flights, there is a revolution in how the aeronautic industry impacts the global environment. Petrochemical consumption in current flights will be replaced with cleaner, battery-powered electric flights.

The named Age of Flight has had an extraordinary carbon footprint, increasing the atmospheric carbon dioxide levels by an estimated 35 percent since around 3 billion passengers are sent into the air each year.

Some Governments (mostly in Europe) have raised the number of industry regulations to lower those skyrocketing greenhouse gases. Moreover, improving flight path efficiency and fuel burn per flight could reduce emissions significantly. Nevertheless, those improvements may not be enough. Fossil-fuel-powered aircraft need to evolve if impacts on the environment are going to be fully mitigated to prevent the worst effects of climate change [1].

For that reason, this project studies the creation, implementation, and development of an electric Vertical Take-Off and Landing (eVTOL) airplane for 7 passengers and 1 pilot for a maximum range of 1000+ km. The fuselage will be formed of carbon fiber composite to reduce weight and it will use electric motors powered by batteries to be fossil-fuel-free.

0.1 OBJECTIVES

This project aims to study, design, and develop the avionics system of an eVTOL upon an ongoing project.

The avionics system will provide the eVTOL with communication and navigation systems, an autonomous Take-Off (T/O) and landing system, as well as the development of cockpit management systems.

Supplying the eVTOL with all necessary tools to obtain an aircraft as autonomous as possible is the final objective of this thesis.

0.2 STRUCTURE

The project is divided into two parts. The first part encompasses everything related to telecommunication engineering and the second part is related to avionics performances.

The project begins with the communication and navigation systems, which include the study of all the necessary and compulsory antennas and sensors to obtain information about the surroundings (weather, obstacles, other airplanes...).

It will continue with the intern communication network of the plane to send the data received by the sensors to the main computer and from there to the cockpit management system, and when necessary, to activate the avionics mechanisms.

The second part of the project consists of developing and building the autonomous system. Starting with an autonomous T/O and Landing system, it will follow the development of cockpit management systems.

Furthermore, there will be a software part where a full-glass cockpit, Fly-by-Wire, and a new touchpad tool for the joystick will be developed. There will be also the design of a virtual intelligent voice assistant called Operational, Navigation, Aerospace (ONA) to send commands to the avionics system.

Moreover, there will be a hardware part for redundancy, Fly-by-Wire, a new touchpad tool for the joystick and to create a touchpad flight control system (FCS) with screens.

0.3 TIMELINE

February/March 2022	Introduction to the thesis subject. Initial planning and identification of the key areas to tackle. Study of the antennas for the avionics system.
April/May 2022	Continue with the study of the antennas. Study of the sensors and telecommunications network for the avionics system.
June/July 2022	Study of the requirements for single-pilot instrumental flight rules aircraft. Study of the cockpit flight management systems.
July/August 2022	Cabin cockpit design and future technology implementation: voice assistant and the future of autonomous unmanned aerial vehicles.

CHAPTER 1. GENERAL AVIONICS SYSTEMS STUDY

1.1 *Introduction*

The words "aviation" and "electronics" are combined to form the name "avionics." It includes all electronic components found in spacecraft, man-made satellites, and airplanes.

Those electronic systems include engine controls, FCSs, navigation, communications, flight recorders, lightning systems, threat detection, fuel systems, Electro-Optic (EO/IR) systems, weather radar, performance monitors, and the hundreds of systems that are fitted to aircraft to perform other missions and flight management tasks [2].

Generally speaking, all electronic systems function dependent on the performance of the aircraft, taking into account their complexity and ultimate goal or purpose.

Avionics are used by all commercial airplanes, helicopters, military fighter jets, unmanned aerial vehicles (UAV), business jets, and spacecraft for a variety of tasks, including service delivery, mission execution, scientific discovery, tracking and reporting of performance metrics, and operation within predetermined safety limits.

Modernization projects like the Federal Aviation Administration's (FAA) Next Generation Air Transportation System project and Europe's Single European Sky ATM Research (SESAR) project heavily rely on avionics today. The most sophisticated avionics systems combine many tasks to [3]:

- Enhance routing, navigation, and performance
- Adding data communications to dynamically build preferred routes
- Make maintenance easier
- Improve situational awareness both on the ground and in the air
- Enabling weather-restricted operations with minimal ground infrastructure
- Boost approach and departure safety
- Enhance the ATM procedure

1.2 *General Avionics Systems*

The cockpit of an aircraft is typically the location for avionics equipment, having most of the systems installed on it.

The electric systems used for avionics systems are different depending on the type of aircraft. 14 or 28 Volts (V) Direct Current (DC) electrical systems are used to power their avionics for the vast majority. However, more sophisticated and larger aircraft require an Alternating Current (AC) system operating at 400 Hz, 115 V AC [4].

All the international standards for avionics equipment are normally prepared by the Airlines Electronic Engineering Committee (AEEC) and published by Aeronautical Radio INC (ARINC).

In a typical plane, aircraft avionics encompasses the following systems:

1.2.1 Communications Systems

The aircraft communication system is used for voice and data communications among the crew members, between the crew members and ground personnel, to communicate with the passengers, with other aircraft, and with ground stations.

Communications in an airplane comprise:

- Radio Communication
 - o High Frequency (HF) system for long-distance voice communications
 - o Very High Frequency (VHF) system for short-range voice communications
- Radio Management Panels
- Selective Calling System (SELCAL) for selective calling using HF or VHF
- Satellite Communications System (SATCOM) for satellite communication
- Aircraft Communications, Addressing and Reporting System (ACARS) for datalink communication
- Interphone Communication
 - o Flight Interphone System for intern cockpit communication and communication with ground mechanics
 - o Cabin Interphone System for cabin crew or cabin crew/pilot communications
 - o Service Interphone System for maintenance personnel on the ground only

- Ground Crew Call System for telling ground crew or flight crew there is a call
- Passenger Address System for passenger announcement from cockpit and cabin crew station
- Audio Management System

VHF for short-range voice communications is the most common system. However, for internal aircraft communications among cockpit-cabin crew-passengers, there is another system called Cabin Interphone System. VHF operates in the frequency range of 118.000 MHz to 136.990 MHz. Usually, channels are spaced 8.33 kHz in Europe and 25 kHz elsewhere.

HF is becoming less common for long-range voice communications due to the advent of SATCOM. HF operates in the frequency range of 2.000 MHz to 29.999 MHz.

The ACARS system transmits messages and reports at scheduled times of the flight to reduce crew workload, although it can be used when necessary [5].

1.2.2 Navigation Systems

Starting with visual references and the basic compass, leading onto radio ground aids and self-contained systems, many techniques and methods are employed in aircraft navigation. Flight planning considers such things as favorable winds, popular destinations, and schedules. Aircraft navigation is therefore also concerned with the management of traffic and safe separation of aircraft.

Navigation stands for the process of determining the position as well as the direction of the aircraft on or above the earth's surface. Avionics uses different navigation systems:

- Gyro-magnetic compass: Earth's magnetic field is used as a reference, leading to simple magnetic compasses in aircraft.
- Ground radio navigation aids such as Automatic Direction Finder (ADF), VHF Omnidirectional Range (VOR), Distance Measurement Equipment (DME), Instrument Landing System (ILS), Long-Range Navigation (LORAN) & Area Navigation System (RNAV)
- Dead-reckoning systems based on the Doppler shift principle, like the Inertial Navigation System (INS)
- Satellite navigation systems based on Global Positioning System (GPS) and Wide Area Augmentation System (WAAS)
- Radar navigation to identify weather conditions

- Air Traffic Control (ATC) based on Secondary Surveillance Radar (SSR) with Traffic Alert and Collision Avoidance System (TCAS) as a backup system

A combination of all these navigation systems is used to automatically calculate the position of the aircraft and display it to the flight crew on moving map displays [6].

1.2.3 Monitoring Systems

All monitoring systems are in the cockpit, more specifically in the glass cockpit. It is referred to as the use of computer monitors to display all the flight data information on screens instead of analogically.

Finding the right balance between manual and automatic control in glass cockpits is one of the biggest problems. The tendency is to try to automate flight operations while keeping the pilot constantly informed.

A glass cockpit usually has an Electronic Flight Instrument System (EFIS) with different Liquid Crystal Display (LCD) control panels and displays:

- Primary Flight Display (PFD) displays all information critical to flight (calibrated airspeed, altitude, heading, attitude, vertical speed, and yaw) instead of having different analog displays, reducing the amount of time necessary to monitor the instruments and improving the pilot's situational awareness (alerts by changing color or shape of the display).
- Multi-Function Display (MFD) displays navigational and weather information from multiple systems such as current route plan, current location over terrain, winds... It can also display information about aircraft systems, such as fuel and electrical systems.
- Engine Indicating and Crew Alerting System (EICAS) displays information about the aircraft's systems, including its fuel, electrical, and propulsion systems (engines). It improves situational awareness by allowing the crew to view complex information in a graphical format and by alerting them to unusual or hazardous situations. Electronic Centralized Aircraft Monitor (ECAM) is a similar system used by Airbus, which recommends remedial action as well as providing all EICAS functions.[8]

1.2.4 Aircraft Flight Control Systems

A conventional fixed-wing aircraft FCS consists of flight control surfaces, the respective cockpit controls, connecting linkages, and the necessary operating mechanisms to control an aircraft's direction in flight. Aircraft engine controls are also considered flight controls as they change the speed [9].

In the cockpit, there are:

- **Primary controls**

- Control yoke, center-stick, or joystick for aircraft's roll and pitch by moving the ailerons or the elevators
- Rudder pedals to control yaw by moving the rudder
- Throttle controls for engine speed or thrust for powered aircraft

Independently on which variant flight control surfaces use the aircraft, the aircraft FCS will be designed conventionally to avoid pilot confusion [9].

- **Secondary controls** for finer pilot control over the flight and reduced workload

- Wheel or another device to control elevator trim and maintain a constant specific pitch attitude
- Wing flaps controller
- Slats
- Spoilers
- Air brakes
- Variable-Sweep wings... [9]

The FCSs can be:

- **Mechanical**

Manually operated FCSs are the most basic method of controlling an aircraft. Currently used in small aircraft.

It uses a collection of mechanical parts such as pushrods, tension cables, pulleys, counterweights, and sometimes chains to transmit the forces applied to the cockpit controls directly to the control surfaces.

Increases in the control surface area and higher airspeeds resulted in higher aerodynamic loads on the FCSs, requiring larger forces. Hydro-mechanical FCSs appeared [9].

- **Hydro-mechanical**

Hydraulically powered control surfaces help to overcome the complexity and weight of mechanical FCSs increase due to the size and performance of the

aircraft. Now it is limited by economy rather than the pilot's muscular strength. The hydro-mechanical FCS has two parts:

- The **mechanical circuit** links cockpit controls with the hydraulic circuits. Rods, cables, pulleys, and occasionally chains comprise this system.
- The **hydraulic circuit**, with hydraulic pumps, reservoirs, filters, pipes, valves, and actuators. Actuators convert hydraulic pressure into control surface movements. Actuators are moved by servo valves that are electro-hydraulic..

Some artificial feel devices are used to feel the load on the surfaces and not overstress the aircraft through excessive control surface movement.

A stick shaker attached to the control column is used to shake it when the aircraft is approaching stall conditions.

Usually, the power is provided to the control actuators by high-pressure hydraulic systems. In Fly-by-Wire systems, the valves are activated by electrical signals. In power-by-wire systems, electrical actuators are used in favor of hydraulic pistons. Power to actuators is carried by electrical cables, which are lighter than hydraulic pipes, easier to install and maintain, and more reliable [9].

- **Fly-by-Wire**

The manual flight control of an aircraft can be replaced with an electronic interface. The movements of flight controls are converted to electronic signals transmitted by wires, and flight control computers determine how to move the actuators to provide the expected response. Without the pilot's awareness, computer commands are also entered to balance the aircraft and carry out additional operations.

There is a further development known as Fly-by-Light that uses fiber optic cables [9].

Modern aircraft have means of automatically controlling flight with the autopilot thanks to the advent of Fly-by-Wire and electro-actuated flight surfaces, which increased safety [9].

1.2.5 Fuel Systems

Fuel control systems are undoubtedly the most prioritized system in an aircraft. Avionics uses two different systems to control the fuel:

- **The Fuel Quantity Indication System (FQIS)** monitors the amount of fuel aboard. Its computer uses several sensors, such as capacitance tubes, temperature sensors, densitometers, and level sensors to compute the mass of fuel remaining on board.

- **Fuel Control and Monitoring System (FCMS)** reports fuel remaining on board similarly and by controlling pumps and valves, it also manages fuel transfers around various tanks:
 - Refueling control to upload to a certain total mass of fuel and distribute it automatically
 - Transfers during flight to the tanks that feed the engines
 - Centre of gravity control transfers from the trim tail tanks forward to the wings as fuel is expended
 - Maintaining fuel in the wingtips and transferring to the main tanks after landing
 - Controlling fuel jettison during an emergency to reduce the aircraft weight [3].

However, as the aircraft will be fully electric, these systems will not be necessary.

1.2.6 Collision Avoidance Systems

With the always-increasing air traffic congestion, and the subsequent demands on ATC resources, the risk of mid-air collision increases. This risk led to the installation of airborne, mid-air collision systems to provide protection independently of ground control and in addition to the nation's ATC system [10].

In the early 1950s, it appeared the concept of the Airborne Collision Avoidance System (ACAS). Nowadays TCAS is worldwide used. It is an automatic surveillance system that helps aircrews and ATC maintains safe separation of aircraft. It is an airborne system based on SSR that interrogates and replies directly between aircraft equipped with a transponder via a high-integrity datalink.

It alerts the crew if another aircraft comes within a predetermined time of a potential collision and provides instructions to avoid a midair collision.

It is important to note that TCAS is a backup system [11].

Smaller aircraft may use simpler traffic alerting systems such as Trajectory Predictor-based Aircraft Simulator (TPAS), which are passive and do not provide advisories for conflict resolution [3].

As air travel departure and arrivals increase and, with them, airport congestion, the danger of collision between aircraft on the ground also increases [10].

Aircraft utilize technologies like Ground-Proximity Warning Systems (GPWS), which utilize radar altimeters as a significant component, to prevent Controlled

Flight Into Terrain (CFIT). The fact that GPWS only offers "look-down" information on height over terrain is one of the system's biggest flaws. To overcome this weakness, modern aircraft use a Terrain Awareness Warning System (TAWS) [3].

However, appropriate avionics may soon be appearing on all aircraft above a certain size in terrain avoidance applications [10].

1.2.7 Flight Data Recorder Systems

Flight Data Recorder (FDR), commonly known as the "black box", is a device used to store and record specific aircraft performance parameters and audio from the cockpit. Its goal is to gather and store information from various aircraft sensors onto a media made to withstand an accident.

The recorder is placed at the area of the aircraft that is most likely to survive a crash, which is often the tail. Investigators can utilize the information gathered by the FDR system to identify if a crash was brought on by a pilot's mistake, an outside factor (such as wind shear), or an issue with an airplane system.

Furthermore, these data have also helped to enhance the design of aircraft systems and the capacity to anticipate future issues as aircraft get older.

Though it is called a black box, the FDR is orange in color to be easily identified in an accident [7].

1.2.8 Weather Radar Systems

Weather systems are important for aircraft flying at night or in instrument meteorological conditions, where pilots cannot see the weather ahead.

Airborne weather radar systems make use of the reflectivity of clouds, precipitation, dust particles at low altitudes, and ice crystals at high altitudes to identify weather conditions and their position and subsequently reroute around these conditions for the safety and comfort of passengers [10, 12]. Another use of weather radar is a terrain-mapping mode that allows the pilot to identify features of the ground (rivers, coastlines, mountains...).

In the age of digital data communications, aircraft systems such as ACARS can receive and transmit information about prevailing weather conditions [12].

It is possible to calculate the rate of precipitation and whether it is rain, snow, or hail by comparing the size of reflections to stored models. The wind speeds and turbulence intensities are measured by Doppler effects, usually by processing the return timing of pairs of pulses [10].

Other weather systems are the lightning detectors, which allow the detection of severe turbulence. Further, observations and extended radar pictures are now

available through satellite data connections, allowing pilots to see weather conditions far beyond the range of their in-flight systems [3].

Weather radars and lightning detectors are usually mounted on the nose of the aircraft. Modern weather displays allow weather information to be integrated with moving maps, terrain, and traffic onto a single screen with a range within about 100 km ahead, simplifying navigation significantly [3, 10].

In modern weather systems, wind shear and turbulence detection and terrain and traffic warning systems can be found, especially in places where ground support is not as well-developed [3].

1.2.9 Flight Management Systems

Aircraft performance data is based on several factors including aircraft weight, altitude, and outside air temperature. Since these parameters are always shifting, performance management systems have gradually automated the process of determining the ideal engine thrust limits, aircraft speed, and altitude. Various tasks previously performed by the crew can now be automated to reduce crew workload.

The Flight Management System (FMS) or Flight Management Computer System (FMCS) combines area navigation and performance management into a single system. The two primary components of the system are the Flight Management Computer (FMC) and the Control Display Unit (CDU). Primary aircraft interfaces with the FMC are the inertial reference system and automatic FCS, including the auto-throttle. An operating program, a navigation database, and a performance database are all included in the FMC. The CDU is the primary interface between the crew and FMC and uses the language of the ATC.

Four-dimensional navigation is possible with FMS. Latitude, longitude, altitude, and arrival time requirements for aircraft may be planned, computed, and then continuously projected. FMS allows airlines to have their financial model in terms of fuel and time costs.

To perform the key functions of area navigation and performance management, the FMS interfaces with many other systems on the aircraft. It integrates radio navigation systems, inertial navigation systems, global positioning systems, and centralized maintenance monitoring.

The FMCS performs all the calculations and predictions required to determine the most economical flight profile, either for minimum fuel, minimum time, or indeed some point in between depending on the operator's financial and commercial models.

When coupled to the automatic FCS, with vertical and lateral navigation modes engaged, the flight crew act as managers monitoring and entering data as required [13].

Health and usage monitoring systems (HUMS) are integrated with the FMCS to give maintainers early warning of parts that will need replacement [3].

1.3 Innovative Avionics Systems

1.3.1 Voice Assistant (ONA)

Voice-controlled technology is continually advancing and just as Apple's Siri, Amazon's Alexa, or Google's Assistant have seamlessly become part of consumer's daily lives, some companies are seeking to have voice-controlled aircraft such as Honeywell Aerospace, Rockwell Collins Advanced Technology Center, and the EU-funded VOICI project [14].

The final objective is to have new cockpit systems that will allow pilots to control the planes with voice commands, sound recording, speech recognition, and Artificial Intelligence (AI), hence reducing pilot workload by increasing automation in the cockpit. The idea is that pilots can give simple commands like tuning a radio frequency, turning to a heading, or asking for the weather somewhere whilst spending less time on tedious and time-consuming tasks like researching weather [14].

The language of the pilots is very different from the colloquial. There is a whole jargon that the AI of the voice assistant must understand and interpret [15]. Unlike other daily voice assistants, pilots need an instant response. Engineers have refined the response time (recognition, understanding, and execution of the command) to 250 milliseconds to ensure that the system can move faster than the pilot [14].

The biggest hurdle by far for cockpit voice recognition is noise [16]. When programming the assistant, it must be able to isolate the background noise of the aircraft engines, the windscreen noise, and the usual noises inside the pilot cabins [15]. The best thing is using individualized speech recognition algorithms tailored to the noise characteristics of specific aircraft [16].

Another issue is that human voices change under stress, under the use of an emergency oxygen mask, and with different English accents. Speech recognition software needs to understand commands uttered under hectic circumstances. This type of voice assistant must be much more reliable than mobile software [16].

Although voice assistance will be common in cabins without a co-pilot, such as pleasure or business aircraft, eVTOLs are going to be the main objective of this tool. In a few years, they will be used as taxis and there will be so many that there will not be enough pilots for everyone. So, the goal is to obtain a voice-operated autonomous pilot, where the passenger himself will give orders to the plane and the assistant will take care of everything [15].

Moreover, nowadays more airplanes start to replace instrument panels and traditional flight computer displays with touchscreen technology [15].

Voice assistance will contribute to the optimization of operations, flight safety and crew awareness, better maintenance, reduced cost of operations, and generally higher efficiency and lower stress [17].

In this project, the introduction of a voice assistant for the eVTOL airplane is discussed. Its name will be ONA Jet, and the company is ONAERO, based on Operational Navigation Aerospace and ONAERO.

CHAPTER 2. DESIGN OF THE COMMUNICATION AND NAVIGATION SYSTEMS

In this section, a study of all the different types of antennas an aircraft can have is done. Later, the antennas that the eVTOL will have are listed with their position to be installed, characteristics, and type of use.

Additionally, there is going to be a specification of all the sensors that it will have and its location. Furthermore, a detailed explanation of the intern communications network system will be developed.

To follow a guideline, the Cessna 172 will be used as a reference model due to its similarities with the eVTOL regarding dimensions and use. Both have similar longitude and wingspan.

A Cessna 172 has around 14 antennas and many sensors. However, some systems like the TCAS or ADS-B are not installed in a typical Cessna 172, but they will be in the airplane. The same happens with the sensors. For the eVTOL to fly autonomously, if possible, more sensors are needed both from airplanes and drones.

Moreover, regarding the communications network, the most modern one will be installed, using, if possible, 5G and optic fiber.

2.1 Antennas

Antennas are probably the most overlooked part of an avionics system, yet they are among the most important [18]. On any airplane, often on its belly, dozens of antennas that are each used for a different purpose can be found [19].

Except for a few boxes (such as autopilots), avionics rely on antennas mostly to help pilots communicate with the outside world, and most of them look like lightning rods or other interesting protrusions [18, 19].

Modern antennas can have many different shapes and sizes, depending on their function. The frequencies at which they operate correctly, and their directional qualities usually determine their shape and placement [18, 19].

To finally decide which model of antennas is going to be used for the eVTOL, a deep comparison between models is carried out, choosing always the antenna that has better performance characteristics regarding temperature, frequencies, weight, and size [51, 52, 53].

In this document, the comparison between antennas is not explicitly made to avoid tedious reading. Only the chosen antennas are described.

2.1.1 Main Antenna Types

2.1.1.1 Dipole Antennas

A basic dipole antenna consists of two conductors (usually metal rods or wires) arranged symmetrically, with one side of the balanced feedline attached to each [20]. The length of the conductors is equal to half of the wavelength of the transmission signal [21]. In Figure 1, the dipole antenna characteristics are shown:

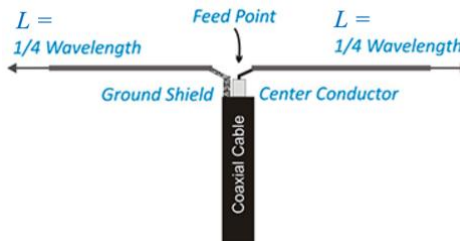

Figure 1. Simple Dipole [20]

The center's dipole antenna receives the AC transmission current. The center of the antenna experiences the maximum current flow during the alternation, and as it moves toward the ends, current flow steadily decreases. It then turns around and flows in the other direction. As a result, the antenna's electromagnetic (EM) field is highest in the center, while its radio wave field is strongest throughout its length. [21].

Most dipoles in aviation are horizontally polarized. Their radiation is omnidirectional, and gains vary from 1.76 dB to 2.15 dB. They are used for a wide variety of applications if omnidirectional radiation or not high gain is required [20].

2.1.1.2 Monopole Antenna (Marconi Antenna)

Half of a dipole antenna is a monopole antenna. It uses the mounting surface of the conductive aircraft skin to generate the second one-fourth wavelength, which gives it the efficiency of a half-wave antenna.

In a perfect world, it would produce an omnidirectional field with the same radiation characteristics as a dipole antenna but with vertical polarization as opposed to horizontal.

It is frequently employed in a variety of VHF airplane communications, where the fuselage serves as the ground plane to provide the antenna with the appropriate conductive length [20, 21].

Figure 2 shows a monopole antenna with its characteristics:

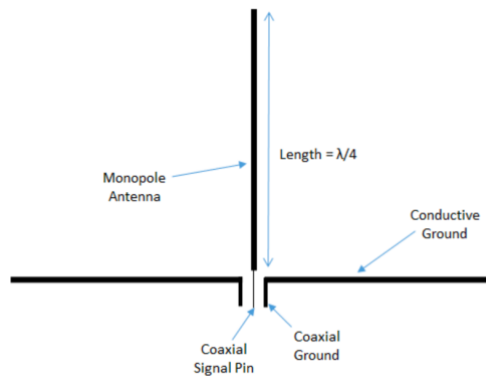

Figure 2. Monopole Antenna [20]

2.1.1.3 Patch Antenna

A patch antenna is a low-profile antenna that can be mounted on a flat surface. It consists of a flat rectangular sheet of metal mounted over a ground plane.

One single patch antenna has very low directivity (around 5 - 7 dB). That is why they are used in arrays, to increase directivity. They are practical at high frequencies when the required dimensions are small.

It is extensively used in aircraft communications, mounted along the fuselage, thanks to its low profile [20].

In Figure 3, a patch antenna with its characteristics is shown and an array of patch antennas as well:

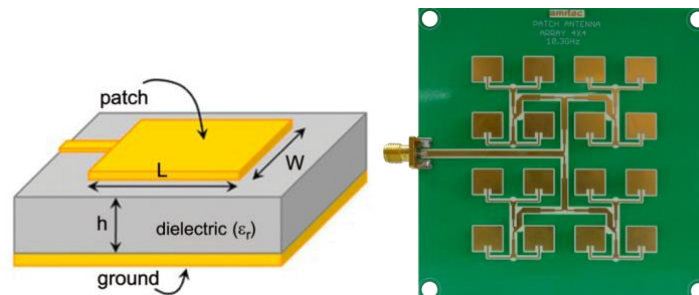

Figure 3. Patch antenna & an array of patch antennas [20]

2.1.1.4 Slot Antenna

A slot antenna is also a low-profile antenna. It comprises of one or more holes or slots cut out of a metal surface, often a flat plate. It can be fed by a microstrip line or by a waveguide.

Figure 4 describes the main characteristics of a slot antenna:

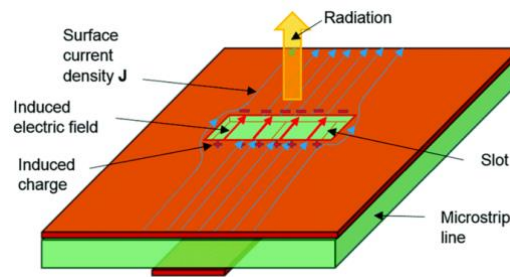

Figure 4. Slot Antenna [20]

It radiates EM waves in a way like a dipole antenna. It is used at Ultra-High Frequency (UHF) (25 GHz) and microwave frequencies (300 MHz).

Its main applications are in radars, where antennas are often based on planar arrays of multiple slots on waveguides, providing high directivity and the possibility of electronic beam steering.

2.1.1.5 Loop Antenna

A loop antenna is a radio antenna consisting of a loop or coil of wire, tubing, or another electrical conductor that makes the antenna more compact and less prone to damage [20].

Used as a receiving antenna due to its small dimensions. It is a highly direction-sensitive antenna, used for Radio Direction Finding (RDF) to locate the position of a transmitter by searching the null reception.

In aviation, modern antennas of the ADF are formed by an array of four small loop antennas using electronic sensors to deduce the direction using the strength and phase of the signals from each aerial.

A loop antenna looks like the one in Figure 5:



Figure 5. Loop Antenna [20]

2.1.2 Required Antennas

2.1.2.1 Navigation & Surveillance Services

2.1.2.1.1 ADF/Non-Directional Beacon (NDB)

The ADF/NDB navigation system is one of the oldest air navigation systems and is still in use nowadays. It works from the simplest radio navigation concept: a ground-based radio transmitter (NDB) sends an omnidirectional signal to a combination of multiple loop antennas operating in the Long-Wave (LW) band (190-535 kHz) [20, 22].

The ADF receives radio signals with two antennas: the loop antenna before mentioned and a sense antenna that determines whether the aircraft is moving toward or away from the station.

The result is a cockpit instrument (ADF) that displays the aircraft's position relative to an NDB station, allowing the pilot to track a course from a station [22].

In Figure 6, an ADF/NDB antenna is shown:

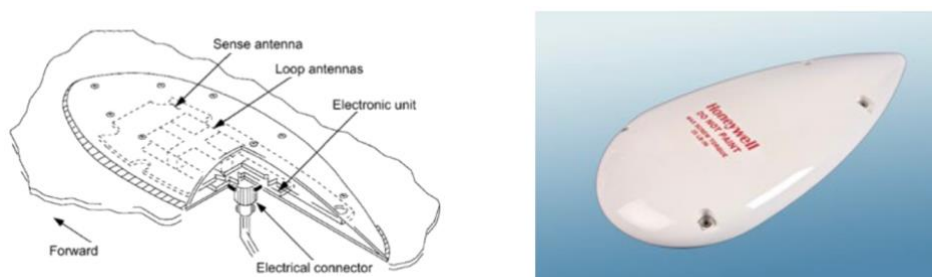

Figure 6. ADF/NDB Antenna, Schematic & S72-1712-10 ADF Antenna [20]

The antenna that will be installed in the aircraft is the S72-1712-10 ADF Antenna from Sensors Systems® INC. It works between 190 kHz and 1,750 kHz with a power of 12 V and 150 mA (Max.). As explained before, it has an omnidirectional pattern [42].

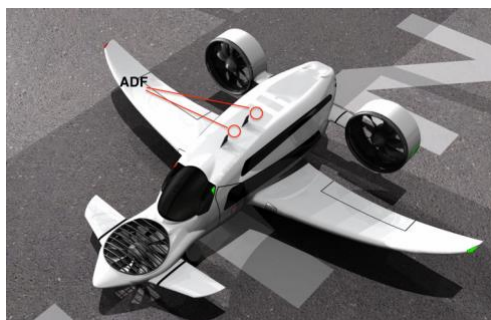

Figure 7. Location of the ADF/NDB antennas

In the eVTOL, two ADF/NDB antennas at the top of the airplane will be installed (See Figure 7).

2.1.2.1.2 DME

The DME is a radio navigation aid used by pilots to determine the aircraft's slant range from the DME ground station location by timing the propagation delay of radio signals. The DME antenna in aircraft sends a pulse signal to the ground-based DME, which response is a pulse signal. The receiver in the aircraft measures the time delay and calculates the slant range distance. There is no azimuth information [23].

It operates in the UHF band (962 - 1,212 MHz for transmitters & 1,025 – 1,150 MHz for receivers). To work properly, the transmitter and the receiver must be in the line of visibility [20].

This is a DME antenna, see Figure 8:



Figure 8. DME Antenna model S65-5366-895L [20]

It can be collocated with a VOR to provide VOR/DME service. For conventional flight operations, DMEs are utilized to provide situational awareness and fix position, and for DME/DME RNAV flight operations, lateral guiding. Additionally, a Tactical Air Navigation (TACAN) unit and a VOR/TACAN (VORTAC) unit both provide DME distance information [23].

For the eVTOL, a DME antenna with ATC Transponder Mode S and ADS-B functions has been found. The S65-5366-895L (See Figure 8) uses the L-Band range between 960 MHz and 1,220 MHz. It is vertically polarized and with an omnidirectional pattern. The power needed is 2,000 Watts (W) at peak and 100 W for continuous [42].



Figure 9. S65-5366-895L Antenna [42] and its location

The DME will use two monopole antennas located at the bottom of the aircraft (See Figure 9).

2.1.2.1.3 Radio Altimeters

A radio altimeter is an airborne electronic device capable of measuring the height above terrain presently beneath an aircraft by timing how long it takes a beam of radio waves to travel to the ground, reflect, and return to the plane. Modern systems use other means, like measuring the change of phase between the transmitted and reflected signal [24, 25].

The radio altimeter supplies the primary altitude information for landing decision height, incorporating an adjustable altitude bug that creates a visual or aural warning to the pilot when the aircraft reaches that altitude [26].

Using a transceiver and a directional antenna, a radio altimeter broadcasts a carrier wave at between 4.2 - 4.4 GHz from the aircraft directly toward the ground [20].

A radio altimeter is very simple (See Figure 10):



Figure 10. Radio Altimeter Antenna [140]

In almost all cases, the display of radio height ceases when an aircraft climbs 2,500 ft (feet) Above Ground Level (AGL), and it restarts when it descends through 2,500 ft AGL. This is confirmed visually by the appearance or disappearance of an “OFF” flag and the emergence of a pointer behind a mask or activation of a digital display.

As the eVTOL will not fly at very high altitudes and needs redundancy to know exactly at which altitude AGL it is, it will have two transmitter/receiver patch antennas at the bottom of the airplane (See Figure 11).

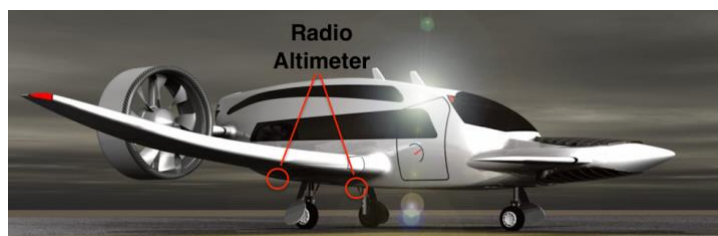

Figure 11. Location of the Radio Altimeter antennas

The radio altimeter antenna chosen is the S67-2018. This model operates between 4.2 and 4.4 GHz. It has a 10 dB gain and needs a power of 5 W average and 500 W peak [42].

2.1.2.1.4 Emergency Locator Transmitter (ELT)

ELT is an emergency radio beacon equipment that broadcasts distinctive signals every 50 seconds in the event of a crash. It operates using a single monopole antenna at 406.025 MHz [20].

Figure 12 shows the ELS antenna model S65-1231:



Figure 12. S65-1231 ELT Antenna [42]

The signal generated is received anywhere in the world by satellites in the International Satellite System for Search and Rescue (COSPAS-SARSAT) satellite system [27].

They are always on the upper skin of the empennage and are made of a flexible material. Some may be buried in the vertical tail or look like small communication antennas. In the aircraft, the antenna will be at the top of the fuselage of the airplane (See Figure 13).

The ELT antenna chosen is the S65-1231 because it supports until 30 G's shock and 10 G's of vibration (See Figure 12). It works at different frequencies: 121.5 MHz, 243 MHz, and 406 MHz. It has an omnidirectional pattern and the power needed is 150 mW for the smaller frequencies only and 5 W for 406 MHz [42].

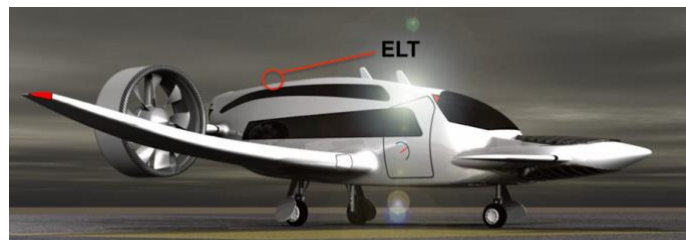

Figure 13. ELT S65-1231 Antenna [42] and its location

2.1.2.1.5 GPS

A GPS antenna is an instrument that receives radio signals at various frequencies from GPS satellites. The impulses are amplified and transformed into electrical signals by the antenna so that a GPS receiver can understand

them. The GPS receiver uses these signals to give an accurate estimate of the receiver's location. It works on or near the Earth's surface [28].

GPS antennas typically provide very weak signals since GPS satellites transmit at less than five watts of power. Because of this, most GPS antennas have amplifiers built into them that are intended to amplify the signal for the receiver. In addition, the GPS frequency is very high and usually operates at 1.57542 and 1.2276 GHz, which requires the GPS antenna to be attached to the very top portion of the fuselage.

GPS antennas are usually patch antennas and look like the one seen in Figure 14:



Figure 14. GPS Patch Antenna model S67-1575-168 [42]

GPS antennas are also designed with DC grounding to protect them against lightning strikes.

Due to communication signals being prone to interfere with GPS operations, the two antennas will be placed as far away from others to mitigate their interference. One will be at the top of the aircraft and the other one on top of the aircraft but near the tail, both oriented parallel to the horizon to assure maximum visibility of the satellites (See Figure 15).

S67-1575-168 will be the GPS antenna used on the eVTOL aircraft (See Figure 15). It works for different frequency bands: J1-L1 1,585 – 1,580 MHz, J1-L2 1,217 – 1,237 MHz, and J2 1,610 – 1,626 MHz. It has RCHP polarization. 1 W is needed for J1 and 60 W CW for J2 [42].

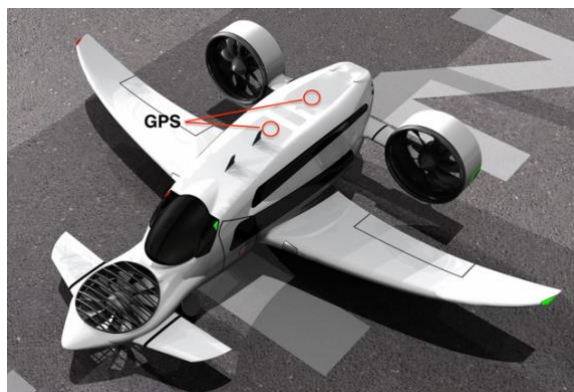

Figure 15. GPS S67-1575-168 Antenna [42] and its location

2.1.2.1.6 ATC Transponder

The transponder of an aircraft is a radio receiver and transmitter in one box that assists in identifying the aircraft on the ATC radar. It receives the ATC interrogation from SSR on 1,030 MHz and transmits its coded reply on 1,090 MHz. This response includes the aircraft's pressure, speed, altitude, and a 4-digit octal identifier [30].

When mounted on the top or bottom of an airplane, the antenna offers omnidirectional, vertically polarized coverage. Its streamlined shape assures minimum aerodynamic drag. Structurally, the antenna consists of a single metal element (See Figure 16) [31].



Figure 16. ATC Transponder Antenna model S65-5366-895L [42] and its location

These antennas have a wider frequency range (BW) and can be used by the DME and ADS-B. DME operates using the frequency range between 962 – 1,213 MHz. Likewise, the ADS-B system uses 978 MHz. This is the reason the same antenna can be used for ADS-B, DME, and transponders (A/C/S) [30].

With the help of satellite navigation or other sensors, an aircraft may identify its location and periodically broadcast it using the surveillance technique known as ADS-B, which makes it possible to follow it. The information can be received by ATC ground stations as a replacement for SSR, as no interrogation signal is needed from the ground [31].

The location for this type of antenna is either on the back or belly of the aircraft, away from other transmitting antennas or sensitive receivers.

The aircraft will have two ATC transponders on top of the fuselage and two more at the bottom will be installed (See Figure 16).

For the eVTOL, the same DME antenna will also be used as ATC Transponder Mode S. So, just two more antennas will be added on top of the aircraft for ATC purposes.

2.1.2.1.7 TCAS

TCAS is an aircraft collision avoidance system designed to reduce the incidence of Mid-Air Collision (MAC) between aircraft. It monitors the airspace

around an aircraft for other aircraft equipped with a corresponding active transponder, independent of ATC, and warns pilots of the presence of other aircraft which may present a threat of MAC [32].

All aircraft with a passenger capacity of more than 19 are required by the ICAO to be equipped with this safety feature. The rule also applies to aircraft with a Maximum Take-Off Weight (MTOW) of more than 5,700 kg.

TCAS constructs a 3D map of the airspace through which the aircraft is traveling, and foresees potential collisions based on the speed and altitudes of the planes passing through the airspace in question. If it detects a potential collision, it will automatically notify each of the affected aircraft, initiating a mutual avoidance maneuver [33].

TCAS antennas, like GPS ones, are patch antennas and look like the one in Figure 18. In modern glass cockpit aircraft, the TCAS display may be integrated into the ND or EHSI. In Figure 17, there is an example of what the pilot sees in the cockpit:



Figure 17. TCAS Antenna [20] and TCAS & EHSI Cockpit Display [32]

TCAS uses the same frequencies as ATC transponders: 1,030 MHz for the receiver and 1,090 MHz for the transmitter. Necessary to remark that the TCAS system is independent of the ATC service [20].

For this purpose, the plane will use the antenna S72-1735-26 (See Figure 18). It operates at the frequencies detailed before and with omnidirectional or direct gains. It requires 1 kW peak power with 1% of the duty cycle [42].



Figure 18. TCAS S72-1735-26 Antenna [42] and its location

TCAS systems usually use two antennas for complete coverage around the aircraft as the antennas are directional and to avoid interference between them. In the eVTOL, they will be located on the top and one on the bottom of the aircraft fuselage (See Figure 18) [30].

2.1.2.1.8 ILS

ILS is a ground-based instrument radio navigation system that provides short-range precision guidance to aircraft approaching and landing on a runway. It indicates the deviation of the aircraft from its optimum path of descent [20].

It is used to execute a precision instrument approach procedure or precision approach. Multiple radio transmissions are used that enable an exact approach for landing with an ILS [34, 35].

Figure 19 explains the different ILS systems used:

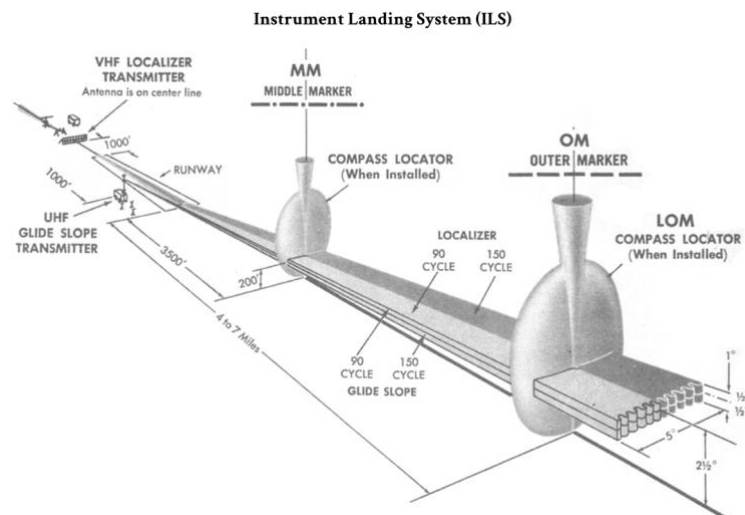

Figure 19. Radio Components of ILS [36]

Localizer is one of the radio transmissions. It serves as a horizontal direction for the runway's center line. The antenna is a half-loop antenna that receives horizontally polarized signals at 110 MHz and is usually located at the nose of the aircraft.

For the project, the localizer antenna that will be used is the S65-147-7, which works between 108-112 MHz and has horizontal polarization [42]. It is shown in Figure 20.



Figure 20. LOC S65-147-7 Antenna & Glide Slope S41422-6 Antenna [42]

Glide Slope is another radio transmission. The Glide Slope broadcast provides vertical guidance of the aircraft down the proper slope to the touchdown point. It is also a half-loop antenna that receives horizontally polarized signals at 330 MHz and is usually located at the nose of the aircraft [20].

The Glide Slope antenna will be the S41422-6, which works at the frequency range between 329 and 335 MHz, and is shown in Figure 20.

In Figure 21, the localizer and the glideslope antennas in the nose of the aircraft, along with other communication and navigation instruments are shown.



Figure 21. Aircraft Nose Components [143]

The ILS also has **compass locator** transmissions for outer and middle approach marker beacons, which aid the pilot in intercepting the approach navigational aid system. The **marker beacons** provide the distance from the runway. It may also include high-intensity lighting at the end of the runways.

There exist different categories of ILS:

- **ILS CAT I:** Provides for the approach to a height above touchdown no less than 200 ft, and with a runway visual range of not less than 1,800 ft.
- **ILS CAT II:** Provides for the approach to a height above touchdown no less than 150 ft, and with a runway visual range of not less than 1,200 ft.

- ILS CAT III A: Provides for the approach without a decision height minimum and with a runway visual range of no less than 700 ft.
- ILS CAT III B: Provides for the approach without a decision height minimum and with a runway visual range of no less than 150 ft.
- ILS CAT III C: Provides for the approach without a decision height minimum and without a runway visual range minimum.

For simple ILS, besides the aircraft and ground equipment, there is a need for an instrument rating. Improving the category of ILS supposes increased aircraft maintenance requirements, and a few training hoops to jump through [36].

As the intention is to create an automated aircraft, ILS CAT III C is chosen. With these ILS and the required equipment, the eVTOL will land without human help.

As above mentioned, the antennas for the LOC and Glide Slope will be at the nose of the airplane (See Figure 21).

2.1.2.1.9 Marker Beacons

A marker beacon is a type of VHF radio beacon used normally in conjunction with an ILS to give pilots a means to determine their position along an established route to a destination such as a runway. Marker beacons are defined as a transmitter that vertically radiates a distinctive pattern to provide position information to aircraft. It is essential for safe aircraft flight [37].

As marker beacon signals are highly directional, the antennas need to be on the bottom of the aircraft (See Figure 22). They are relatively simple and reliable. Normally they are half-loop antennas.



Figure 22. Marker Beacon Antenna [144]

The marker beacons transmit at 75 MHz by an upward-facing directive antenna at known distances along the approach path.

Electronic display aircraft usually incorporate marker lights or indicators close to the glideslope display near the attitude director indicator [35].

The marker beacon antenna will be the S35-1000-1 due to its performance characteristics (See Figure 23). It works at 75 MHz with horizontal polarization. Moreover, it weighs only 0.34 kg whilst other marker beacons have more weight [42].

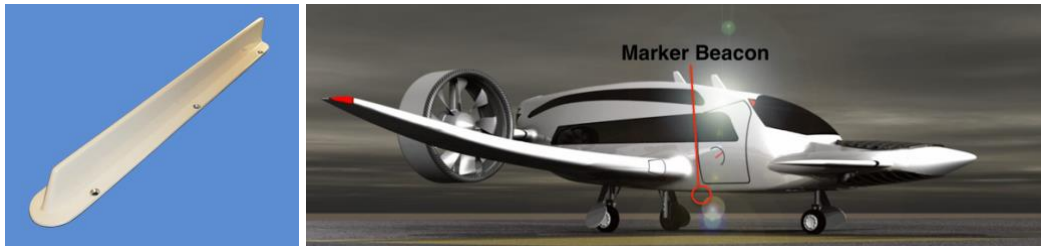

Figure 23. Marker Beacon S35-1000-1 Antenna [42] and its location

As commented before, the marker beacon antenna will be at the bottom of the aircraft fuselage (See Figure 26).

2.1.2.1.10 VOR

A short-range radio navigation system for airplanes is called a VOR. It enables aircraft with a receiving unit to determine bearing information and stay on course by measuring the phase difference between the two signals transmitted by ground radio beacons, one omnidirectional and the second, a directive 360-degree sweeping variable signal [38].

It operates in the VHF band from 108.00 to 117.95 MHz. The receiving antenna is an omnidirectional V dipole (See Figure 24), and its typical location is at the upper part of the horizontal stabilizer, at the vertical fin.



Figure 24. VOR Antenna [145]

For the eVTOL, the S65-247-33 antenna will be used (See Figure 25). It is a dual VOR that provides optimum impedance match over the bandwidth while maintaining omnidirectional radiation patterns. It operates between 108 and 118 MHz [42].

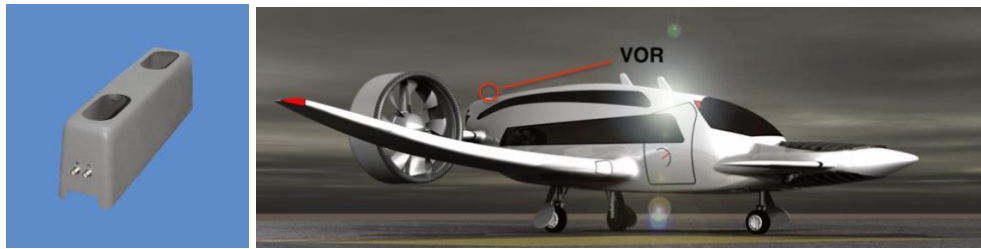

Figure 25. VOR S65-247-33 Antenna [42] and its location

It is normally used for tail-fin installation. As the ONA Jet does not have a vertical stabilizer, the antenna will be installed on top of the aircraft almost at the end to avoid interference with other antennas.

2.1.2.1.11 Weather Radar

An airborne weather radar is a type of radar used to provide information to pilots about the intensity of convective weather. Doppler radars, which make up the majority of modern weather radars, can detect both the strength of the precipitation and the velocity of raindrops.

It is formed by a slot array antenna that is typically located at the nose of the aircraft, as shown in Figure 26:



Figure 26. Weather Radar Antenna [146]

Signals received are processed by a computer and presented on a screen in colors, depending on the magnitude of the precipitation (See Figure 27). It can measure the precipitation, its associated turbulence, and the presence of wind shear. It does not detect clouds [39].

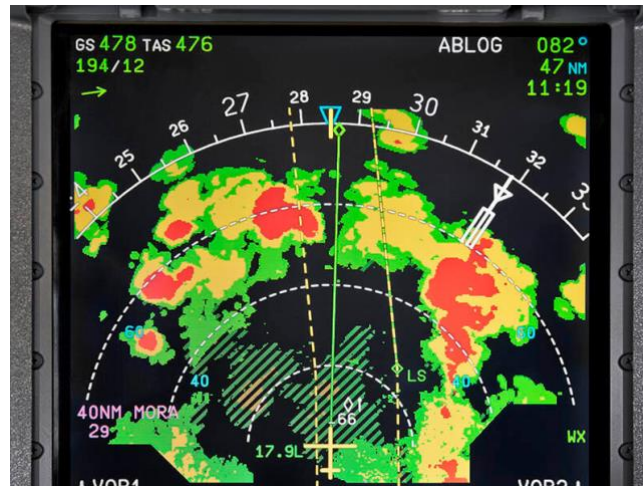

Figure 27. Weather Radar Display Screen [147]

In the plane, the WXR-2100 MultiScan ThreatTrack™ weather radar antenna will be installed (See Figure 28). It is the most advanced weather radar nowadays. It does an automatic weather threat assessment, providing a depiction of the reflectivity of surrounding weather cells, and a threat assessment for each cell detected [43].



Figure 28. Weather Radar Antenna - Rockwell Collins MultiScan WXR-2100 [148]

Of course, this antenna will be located on the nose of the plane.

2.1.2.2 Communication services

An aircraft uses a range of radio frequencies to navigate to its destination and communicate with ATC. To do it successfully, the onboard radio equipment uses different types and sizes of antennas, each designed for its frequency band.

2.1.2.2.1 VHF Voice Communications

The majority of communication radios used in aviation are VHF models. This equipment is used for short-range communication (only line of sight range), and it operates at the VHF band between 118 MHz and 136.975 MHz.

VHF radios are used for communications between aircraft and ATC, as well as air-to-air communication between aircraft [41].



Figure 29. VHF Antenna model DM C50-17 [149]

VHF antennas are monopole antennas. They need good ground. With a metal aircraft, there is no problem because there is enough good conductive ground metal available. With composite aircraft, a sheet of aluminum mounted on the ground is needed.

For our eVTOL, one VHF voice communication antenna at the top of the aircraft and another at the bottom will be installed, but each installation is susceptible to shadowing from the fuselage. The one at the top would be better for communications while the aircraft is still on the ground, and the antenna on the bottom would be better for communications while airborne, having a clear shot of the ground antenna site in each case [40].

The VHF antenna will be the DM C50-17 (See Figure 29). This model provides the lightest weight and the strongest blade antenna at a lower cost. Its frequency range is between 116 and 156 MHz [44].



Figure 30. Location of VHF antennas

As before mentioned, there will be one VHF antenna on top of the aircraft and another at the bottom of it (See Figure 30).

2.1.2.2.2 HF Voice Communications

High-frequency radio waves travel in a straight line and do not curve to follow the earth's surface. They bounce off the ionosphere layer, extending the range of HF signals beyond the line of sight.

Transoceanic aircraft use the HF band between 2-30 MHz for long-range voice communications.

However, as the eVTOL will be used as an urban taxi or for short-range trips, the HF antenna is not needed.

2.1.3 Weight & Cost Estimation

As the project is in development, the price of each antenna has been researched, its weight, and how many of them are needed. Some of the prices are not accessible through the internet, so a request to the company provider has been done. Some providers answered while some others did not. However, an estimation of the cost and weight has been done with the available information.

In Table 1, a summary of all the antennas specified in the previous section can be found (Request means it has been requested without any answer):

Antenna	Model	Quantity	Price (€/unit)	Weight (kg)	Provider
ADB/NDB	S72-1712-10	2	4,970	4	Sensors Systems®
DME/ADS-B	S65-5366-895L	2	855	0.15	Sensors Systems®
ATC Transponder	S65-5366-895L	2	855	0.15	Sensors Systems®
Radio Altimeter	S67-2018	2	2,385	0.12	Sensors Systems®
ELT	S65-1231	1	1,650	0.66	Sensors Systems®
GPS	S67-1575-168	2	1,565	0.46	Sensors Systems®
TCAS	S72-1735-26	2	7,120	0.77	Sensors Systems®
LOCALIZER	S65-147-7	1	285	1	Sensors Systems®
GLIDESLOPE	S41422-6	1	1,040	0.27	Sensors Systems®
MARKER BEACONS	S35-1000-1	1	395	0.35	Sensors Systems®
VOR	S65-247-33	1	4,495	1.36	Sensors Systems®
Weather Radar	WXR-2100	1	Request	10.5	Collins Aerospace
VHF Comm	DM C50-17	2	4,550	1.5	L3HARRIS™
TOTAL		20	~52,465*	~28.44	

Table 1. Summary of all antennas, prices, and weights

***Price without the “Request” ones**

2.2 Sensors

Electronic sensors offer accurate feedback and simple control of aircraft systems. Various aspects, including monitoring, control, and navigation, may be measured with the use of sensors. Consequently, avionics play an important role in modern aviation.

Avionic systems include complicated tactical systems for airborne early warning signals as well as systems for communication, navigation, and display.

The sensors found in an aircraft are all destined to the flight instruments. Many of these gadgets and sensors provide extra indications to the cockpit's displays so that the pilots can take the necessary actions and safety precautions to avert any disaster or tragedy.

Aircraft computer systems receive data from various sensors. These computers process sensor inputs, apply compensating factors and communicate data to the cockpit displays [45].

This enables the crew and maintenance people to notice even the smallest defect that a situation or flying arrangement might pose. It also enables pilots to make choices well in advance depending on the sort of system or component that is about to fail or has already failed [46].

Many types of sensors are used on aircraft. As the plane will have some characteristics from aircraft and others from drones, it will have sensors from both types of flying machines.

A guideline based on all the sensors from a conventional aircraft has been followed. Figure 31 and Figure 32 show, for the different systems of an aircraft, the necessary sensors:

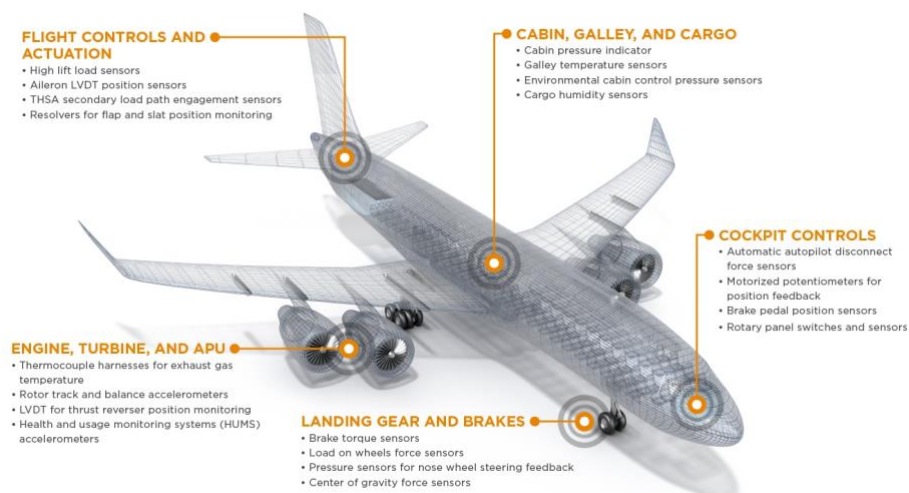

Figure 31. Aircraft system sensors I [150]



Figure 32. Aircraft system sensors II [151]

From drones, some more sensors have been added based on different drone sensors shown in Figures 33 and 34:

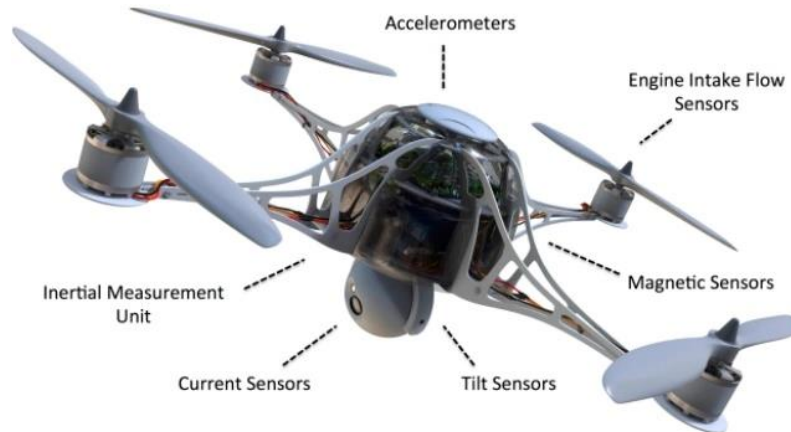

Figure 33. Drone sensors I [152]

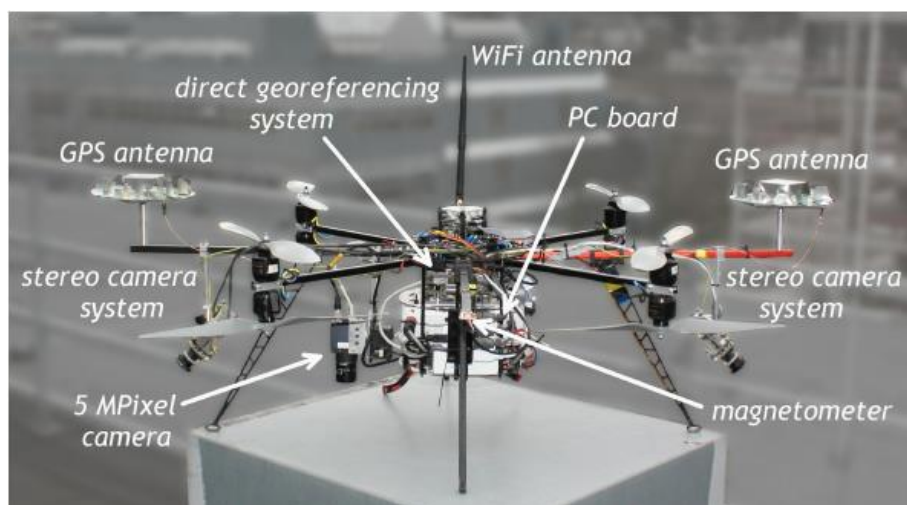

Figure 34. Drone sensors II [153]

2.2.1 Flow Sensors

Flow sensors work in combination with liquid level sensors, and they monitor the flow rates of liquid levels in an aircraft. This includes the flow rate and quantities of lubricating oil in bleed air systems [45].

2.2.1.1 Pitot Tube

Pitot tubes work as flow sensors that are most often used in aviation to measure the speed and pressure of air, liquid, or gas. These readings allow pilots to gauge airspeed, Mach number, altitude, and altitude trend and have a wide variety of applications in other equipment.

The tubes are often visible along the wing or on the front fuselage underneath the cockpit. The pitot tube will be beneath the cockpit (See Figure 35):



Figure 35. Pitot Tube beneath the cockpit [154]

In this technique, a pitot tube is inserted inside a static-port tube. The side apertures (static ports) monitor static pressure while the front hole detects stagnation pressure. The difference between these two measurements is called dynamic pressure, which is used to calculate airspeed.

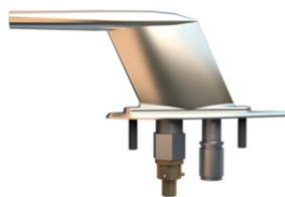

Figure 36. Pitot tube from Collins Aerospace [155]

Errors in pitot-static system readings can be extremely dangerous as the information obtained from the pitot-static system is potentially safety-critical [48].

Like most commercial aircraft, the airplane will have two completely independent pitot tube systems to provide redundancy in the case of system failure. The pitot tube systems used will be from Collins Aerospace (See Figure 36).

2.2.1.2 Flow Meter at Hydraulic System

The use of hydraulic systems is quite common in the aviation sector. Hydraulic power is used to operate everything from the flight control surfaces and flaps to the landing gear and brakes.

The appropriate volume of hydraulic fluid is necessary for proper operation. Significant functional issues might result from using the wrong amount of hydraulic fluid.

Hydraulic fluid may be measured using flow meters as it moves between points in the systems. By being able to track volume and current viscosity, it is feasible to verify the volume of the fluid present to guarantee correct operations and that it is at the proper viscosity to offer adequate resistance while the systems are in use.

Besides, flow meters can monitor the amount of fluid leaving the system when the hydraulic fluid has to be refilled and flushed from the system as well as the amount being sent back in, ensuring the right volume of fluid is present after the replacement [49].

The ONA eVTOL is being developed now and the flaps, in case there are, and other systems that used to be hydraulic may become electrical.

However, the landing gear and the braking system will be hydraulic. The flow meter will be spotted to control the amount of hydraulic fluid used for these actions.

The flowmeter chosen for the hydraulic system is the P213 Piston Flow Meter. It is used for testing hydraulic fluid throughout hydraulic pumps, cylinders, and actuators to operate wheels. Moreover, it is also used to test the valve's leak and measure brake fluid in the line. In Figure 37 there is a P213 Piston Flow Meter:



Figure 37. P213 Piston Flow Meter [156]

2.2.2 Liquid Level Sensors

In aircraft, liquid level sensors can be found in thermowells, and reservoirs, tanks, sumps, and gearboxes.

These sensors monitor oil and coolant levels as well as fluid levels in portable and gray water reservoirs, collection sumps, and hydraulic reservoirs.

Liquid level sensors help pilots to know exactly how oil levels are doing, among other things [50].

To detect the presence or absence of liquid or interface at the sensing location, the FCI Model AS-LLS liquid level switch will be installed (See Figure 38).



Figure 38. FCI Model AS-LLS [53]

2.2.3 Pressure Sensors

Pressure sensors are the most common sensors in an aircraft. They monitor the pressure in hydraulic systems, braking, moving control surfaces, raising and lowering landing gear, engine oil, oxygen tanks, heating, and coolant fluids, providing a response that balances out pressure in each specific environment [54].

They are also used to monitor internal pressure both in the cabin and in the cargo area through cabin pressure indicators and cabin pressure control sensors. Moreover, they are used within the cockpit as a part of the autopilot controls [47].

Pressure sensors can be found in different parts of the aircraft:

- **Hydraulic Systems:** To power primary flight controls, as well as controls for safe landing combining raking and thrust reverse, pressure switches and sensors are installed to ensure that the actuators have the necessary pressure to move parts of the plan when needed to turn, maneuver, or land [54].
- **Environmental Control Systems (ECS):** It provides clean air, thermal control, humidity control, and cabin pressure for the crew and passengers. Pressure and temperature switches and sensors provide the information to the aircraft computer to maintain a comfortable environment in the aircraft or, in the case of loss of pressure, deploy the oxygen masks [54].
- **Air Data Computer (ADC) or Aeronautical Decision Making (ADM):** Air Data Pressure Measurement from pitot and static ports provides critical information to the Integrated Air Data Inertial Reference System (ADIRS) to enable the pilot a co-pilot to understand key flight information

such as airspeed and altitude, which is then computed and displayed on the glass cockpit [55].

- **Auxiliary Power Unit (APU):** Provides essential functionality to the aircraft, such as electrical power, pneumatic or hydraulic to start the engines, lighting, air conditioning, and water pressure to the main cabin crew and passengers, when grounded. In case of engine failure, it provides the power to restart the engine during flight. The pressure sensors measure the critical parameters to ensure these systems operate safely and efficiently [55].

For hydraulics, ECS, coolant and heating systems, lubrication systems oil, and other fluid and gases, the best pressure sensor is the AS-PT sensor from FCI Aerospace. In Figure 39, the AS-PT pressure sensor is shown:



Figure 39. AS-PT sensor [157]

Among all the above pressure sensors utilities mentioned, on the operational side, they can be used also for:

- Sensors that monitor the stress on the landing gear and the lift of the aircraft
- Position sensors, both for the entire aircraft and its individual parts
- Torque sensors used for the brakes
- Measuring the steering feedback of the nose wheel
- Center of gravity calculations

Some of these ideas are explained in more detail below, but they have been also mentioned here because they fall within this sensor class [47].

2.2.4 Position Sensors

Position sensors are used to provide position reference information and measure the displacement of aircraft components in onboard equipment or ground service systems.

They may also measure angular speed and normally the information includes redundancy without a common failure mode.

The technologies used for position sensors are the Rotary Variable Differential Transformers (RVDTs), the Linear Variable Differential Transformers (LVDTs), the hall-effect technology, and resolver sensors [56, 57].

Some of the applications that position sensors are used for are:

- FCSs (Stabilizer position, valve, and actuator position...)
- Fly-by-Wire Systems
- Cockpit Controls (Cabin comfort functions...)
- Engine Controls (Valve position...)
- Electric Brake/Brake-By-Wire Systems (Valve position, actuator position...)
- Landing Gear (Valve position, actuator position...)

Honeywell position sensors will be installed in the eVTOL. Model 1LVTTxxxADB as LVDTs sensors, model HMC1501/1512 as RVDTs and hall-effect sensors, and 3-Inch series as resolver sensors. In Figure 40, a sensor of each type is shown.



Figure 40. Honeywell Position Sensors (LVDTs, RVDTs + Hall-Effect & Resolver)

[158, 159, 160]

2.2.5 Temperature Sensors

Temperature sensors also play an important role. They monitor the conditions of hydraulic oils, refrigerants, and environmental cooling systems. They also measure the temperature of various engine parts in the aircraft. They have special importance to activate the de-icing system together with the weather sensors.

These sensors include bi-metallic temperature gauges, thermometers, Wheatstone bridge indicators, Resistance Temperature Detectors (RTD), ratiometers, and thermocouples.

Temperature sensors allow the pilot to see if there is anything wrong with the aircraft when areas become too hot or too cold [45].

They also monitor the flight deck and cabin internal temperatures to maintain a correct climate inside the airplane.

Honeywell will provide us with the temperature sensors as with the position sensors. Thermostats (3500 Series), temperature probes (500 Series), and RTD (700 Series) sensors will be installed on the eVTOL. In Figure 41 the sensors specified before can be seen, respectively:



Figure 41. Honeywell Temperature Sensors [161]

2.2.6 Force, Vibration & Torque Sensors

These types of sensors are used on aircraft to measure torque and force in primary and secondary flight controls, pilot force feedback, yaw and pitch, payload system force, and braking system force, as well as actuation systems, autopilot functions, and center of gravity [58] (See Figure 42).



Figure 42. Schema where force sensors should be [162]

As there are many applications, the aircraft needs different force, torque, and vibration sensors. The triaxial force sensor model 260A13 from PCB Piezotronics, the torsion force sensor model 208C03 from the same company, and the embedded force sensor from Sensy* will be installed.

Figure 43 shows the different sensors mentioned:



Figure 43. Triaxial and Torsion force sensors from PCB Piezotronics & Embedded Sensy* force sensor [163, 164, 165]

2.2.7 Instrument and Operational Sensors

Sensors are integral to the instrument systems on board aircraft, including flight, engine, and navigational instruments. Those sensors encompass everything that helps the aircraft to fly safely.

To fly safely, these sensors provide information on the condition of the aircraft, engine, components, aircraft's attitude in the sky, weather, cabin environment, navigation, and communication [59, 60].

The flight instruments include the followings:

2.2.7.1 Altimeter

Altimeters are tools used to determine how high an airplane is above the ground directly underneath it. This height may be Above Ground Level (AGL) or Above Sea Level (ASL).

They are generally used for maintaining a constant altitude, whether during a routine flight, reduced visibility maneuvers, or for automatic actions. They could also be employed during crucial flying phases, including landing [61].

There are four main types of altimeters:

2.2.7.1.1 Barometric Altimeters

By comparing the air pressure at the present height with the pressure at sea level, one may determine their altitude. Normally, the greater the altitude, the lower the pressure.

Weather variations, which can affect both pressure and temperature, can also induce fluctuations in air pressure [61].

2.2.7.1.2 Radio Altimeters

Radio altimeters are based on the principle of reflection of EM wave pulses by the surface of the earth or sea. These waves fall within the radio spectrum range.

Since EM waves move at the speed of light, calculating the distance is almost instantaneous. Radio altimeters are a trustworthy and accurate way to measure height, despite the fact that they are impacted by surface imperfections that cause variations in the radio signal.

As the time delay between transmission and reflected wave is too short, two antennas physically separated are required to avoid interference [61].

2.2.7.1.3 GNSS

Receiver devices for the Global Navigation Satellite System (GNSS) may also calculate altitude by trilateration using four or more satellites. To make this calculation, the time of flight of radio waves from one known point to another is again used.

Although useful for many Unmanned Aerial Vehicles (UAVs) during flight, GNSS is not accurate enough to provide height information for precision maneuvers such as low-altitude flight or landing, and another backup system, such as a barometric altimeter, is needed [61].

2.2.7.1.4 Laser Altimeter

This altimeter works by using EM waves within the visible range of the spectrum instead of radio waves.

They work the same way as radio altimeters. It is possible to measure the amount of time it takes for a signal to travel from the transmitter to the surface and back.

After being reflected, the light beam is picked up and focused onto an infrared-sensitive photocell detector using a sequence of mirrors and lenses [61].

2.2.7.1.5 Use of altimeters in aviation

GNSS and barometric altimeters may be used as a part of the sensor suite within an autopilot's Attitude & Heading Reference System (AHRS). Autopilots

use these sensors to estimate the altitude as part of the estimation algorithm. They enhance the overall accuracy of the system and provide a level of robustness and redundancy that other systems simply do not have.

However, when a precision landing capability is required, or low altitude maneuvers must be provided for within the FCS, then a precision altitude measuring device such as a laser or radio altimeter will also be required. They are usually integrated for customers with UAV Navigation's autopilots for automatic landing and, also advanced flight modes such as sea-skimming [61].

The eVTOL will have all altimeters mentioned above to be possible to be someday fully autonomous.

The barometric altimeter installed will be the Honeywell Precision Barometer and Altimeter (HPB/HPA) due to its high accuracy. The model is shown in Figure 44:



Figure 44. Honeywell Precision Barometer and Altimeter (HPB/HPA) [166]

The radio altimeter installed will be the DRA-2421 model from Wavenet because it has been designed especially for use in UAVs and only weighs 250 g. In Figure 45 the specific model is shown:



Figure 45. DRA-2421 Radio Altimeter from Wavenet [167]

The GNSS altimeter will be the GPS and it is specified in a previous section.

The laser altimeter installed will be the AR3000 model from Acuity. Figure 46 shows this model:



Figure 46. AR3000 Acuity Laser Altimeter [168]

2.2.7.2 Airspeed Indicators

An aircraft's airspeed indicator is a differential pressure gauge based on the pitot tube, static pressure, and temperature data. It compares ambient air pressure with ram air pressure to determine the aircraft's true airspeed, that is how fast the aircraft is moving through the air.

As the eVTOL will be mostly digital, ram air from the pitot tube and static air from the static vent/vents are run into the sensing portion of the computer which will carry out all the ADC's computations for true airspeed. Temperature is also an input. It is possible to alter this data and do computations to provide a correct airspeed value digitally to the cockpit for display [62].

2.2.7.3 Vertical Speed Indicator (VSI)

A VSI, also known as the rate of climb indicator, is a direct reading, differential pressure gauge that compares static pressure from the aircraft's static system with the static pressure surrounding the instrument case.

Same as with the Airspeed Indicator, the rate of climb indication in a digitally displayed instrument system is computed from static air input to the ADC. The vertical speed is often displayed near the altimeter information on the PFD [62].

2.2.7.4 Compasses and Magnetometers

A magnetometer or compass is a navigation instrument that can identify a specific reference direction in the horizontal plane, allowing horizontal angles to be measured in this direction.

It tracks the orientation of a magnetic needle within Earth's magnetic field. It does not require a source of energy, making it highly resistant to failure.

It is normally used to determine the magnetic heading of the aircraft and give support to other devices. However, the magnetic north does not align with the geographic north. To adjust it, the magnetometer must be constantly recalibrated with an offset to yield an accurate absolute measurement of the direction of the geographic north.

Onboard modern aircraft, Three-Axis Magnetometers (TAMs) are widely used, giving the pilot a wide vision of the aircraft's heading and attitude.

Usually, the accuracy, robustness, and reliability of magnetometers may be augmented by using other systems such as GNSS [63, 64].

The magnetometer will be installed in the wingtip. The magnetometer will be the GMU-44 model from Garmin. In Figure 47, the magnetometer model that will be used can be seen:



Figure 47. GMU-44 Garmin Magnetometer [169]

2.2.7.5 Attitude Heading & Reference Systems (AHRS)

Gyroscopes and other equipment have been overtaken by AHRS in current airplanes. They receive data from Micro Electronic-Mechanic Systems (MEMS) devices, GPS, solid-state magnetometers, and solid-state accelerometers and display attitude information such as roll, pitch, and yaw in addition to aircraft heading.

The operations are carried out by an AHRS device using 3-axis MEMS accelerometers, rate gyros, and a 3-axis magnetometer.

This is because, during turning or banking, accelerometers supplemented by a magnetometer can tell the pilot how the attitude is changing. Moreover, the pitch and roll changes take the aircraft to another place, known as the GPS, so the position, velocity, and time (PVT) solutions from the GPS are another way to correct those evolving AHRS solutions.

In summary, an AHRS using 3 different MEMS can provide a wealth of pilot information on a PFD display [65].

The AHRS that will be installed in the eVTOL is the GRS-77 AHRS from Garmin. The model is shown in Figure 48:



Figure 48. GRS-77 Garmin AHRS [170]

2.2.7.6 Angle of Attack (AOA)

The AOA (α) is the angle that the chord of the plane's airfoil makes with the direction of the wind hitting the aircraft.

It is directly correlated with the Lift Coefficient (CL), thus with the lift, which has a drastic impact on the ability of the airplane to T/O, fly, and land.

The AOA sensor is a device that measures the plane's α and indicates that measurement to the pilot, providing feedback on how the pilot can achieve the perfect α for any situation. A pressure differential, transducers, or inertial references are all used in its operation.

The eVTOL will have installed the transducer sensor because is the most common. They can change direction in response to the relative wind's impact on the aircraft and/or airfoil, and they can also assess the angle of attack directly [71].

The α model sensors that will be installed in the eVTOL are the Stall Warning Angle of Attack Transducer (SWAAT) and Stall Protection Angle of Attack Transducer (SPAAT) sensors from Collins Aerospace. The model is the 0863D1 and it can be seen in Figure 49:



Figure 49. The Angle of Attack 0863D1 Sensor [155]

2.2.7.7 Humidity Sensor

Humidity sensors are intended for air ducting where humidified air is carried to seating areas, as well as to detect icing conditions [72].

Although it is still passing some tests, AMETEK model 8TJ315AAA1 is the best humidity sensor for the eVTOL. In Figure 50 there is the shape of the sensor:

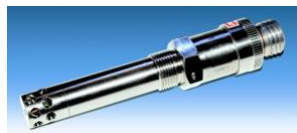

Figure 50. AMETEK Humidity Sensor [171]

2.2.7.8 Fatigue Meter Sensor

Fatigue meters and counting accelerometers monitor the acceleration and deceleration of structural life consumed during a flight.

The fatigue meter is an integrated set of sensors, data acquisition equipment, and software that stores the G level counts for each flight and the total flights. The non-volatile data memory stores the accelerometer information and prevents the loss of data.

The fatigue meter can be used with additional data to form realistic statistics of structural airframe fatigue life, providing reliable and accurate information to the system [73].

The eVTOL will have installed the Solid State Fatigue Meter from AMETEK. It is small and has the following appearance (See Figure 51):



Figure 51. AMETEK Fatigue Meter Sensor [172]

2.2.8 Proximity Sensors

Remote electronics and passive proximity sensors constitute a proximity sensing system. The electronics provide the excitation signal for the sensors and communicate the position status of various mechanical systems that use the sensors to other aircraft systems which need this information. The electronics themselves can be configured as modules or dedicated Line Replaceable Units (LRUs) to support a variety of different system architectures and users.

The non-contact, programmable proximity sensors are used in aircraft applications to detect the presence or absence of a target. They typically consist of two pieces, one of which is applied to the moving element (the target) and the other to the static part.

The sensors can detect most internal failures and display a fault output to a pilot or maintenance worker to help improve the performance of the aircraft and reduce aircraft downtime and maintenance costs.

The proximity sensors can be designed into a range of aircraft systems such as thrust reverser actuation systems, flight controls, aircraft doors, cargo loading systems, evacuation slide locks, landing gear, cabin controls, and APUs.

Depending on the specific application or environment, different proximity sensors are installed: inductive, capacitive, photoelectric, EM, and ultrasonic [66, 67].

Two different proximity sensors that Honeywell has developed depending on the aircraft application will be used: the GAPS Series and the HAPS Series. In Figure 52, there is one sensor from each Series:



Figure 52. GAPS & HAPS Honeywell Proximity Sensors [173, 174]

The first one will be used for general aerospace applications (Aircraft doors, cargo loading systems, cabin controls...), whilst the second one for harsh ones (Thrust reverser actuation systems, flight controls, evacuation side locks, landing gear, APUs...).

2.2.9 Other Sensors

2.2.9.1 Collision Avoidance

As the final objective is to obtain a fully autonomous aircraft, the eVTOL will have the collision avoidance systems of a conventional aircraft and some more specific systems from drones or UAVs.

From a conventional aircraft, it will be installed the TCAS system as mentioned in the antennas section.

From drones, a robust Detect & Avoid (DAA) system is needed to guarantee security in the nearby airspace to avoid collisions and damage. The three most common technologies used for a DAA system are Optical Cameras, LIDAR (Light Detection & Ranging), and RADAR (Radio Detection & Ranging).

All of them are needed to combine the strengths of each of them and detect and avoid possible obstacles. In Figure 53 the main characteristics of each system are explained (5: Very Adequate, 1: Inadequate) [74]:



Figure 53. Characteristics of the most common DAA Technologies: Optical Cameras, LIDAR & RADAR, respectively [74]

2.2.9.1.1 Optical Cameras

A crucial source of information is given by the optical pictures produced by traditional cameras. Long-distant object detection and identification are both quite accurate.

However, they rely on clear air conditions as well as sunlight and require sophisticated processing (stereoscopy) to calculate distances [74].

For the eVTOL, the CASIA X Collision Avoidance System will be installed. It consists of a five-camera solution to obtain maximal situational awareness. The range is 1,200 m on average, and 1,900 m on maximum. The system has also a computer vision DAA. In Figure 54, the computer with one camera is shown:



Figure 54. CASIA X Computer and Cameras for DAA System [175]

2.2.9.1.2 LIDAR System

With LIDAR, the environment is scanned by a pulsed laser beam, and the amount of time it takes for the signal from the item to return to the detector is measured.

In contrast with optical cameras, LIDAR allows very precise detection of the position and distance of the objects, but with a very narrow field of view [74].

For the ONA eVTOL, the LIDAR system from Luminar will be installed. Currently, this system is being installed in Airbus's VTOLs, which are in development. The system is the following seen in Figure 55:



Figure 55. Luminar LIDAR System [176]

2.2.9.1.3 RADAR

Radio waves are used by RADAR to measure object location, distance, and velocity. Although the resolution is lower than in the case of LIDAR, RADAR can work under harder atmospheric conditions [74].

The eVTOL will have installed the Honeywell IntuVue RDR-84K Band RADAR System. This RADAR has a high resolution for 3D imaging and a 3 Km range. It can be used for traffic detection, bird strike avoidance, weather radar, terrain mapping, and obstacle detection [75].

There will be some of them installed around the airplane. The RADAR is the following seen in Figure 56:

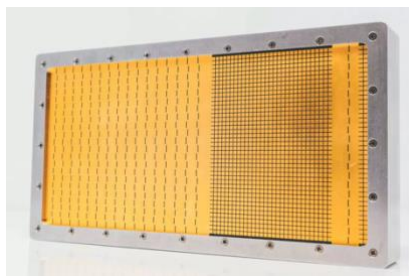

Figure 56. Honeywell IntuVue RDR-84K Band RADAR System [75]

2.2.9.1.4 Autoland, feature of the Garmin G3000 flight deck

As is explained below in section [2.3.1.1](#), the cockpit of the eVTOL will have the Garmin G3000 flight deck.

The G3000 integrated flight deck has a new feature called Autoland. This system can monitor the pilot's activity or inactivity, and cabin pressure, activating automatically the Autoland or Emergency Descent Mode if no activity is detected. Moreover, if the passengers recognize the pilot is in distress, they can press the Autoland button.

The system announces "Emergency Autoland Activating", and then it declares an emergency with ATC via automated voice radio messages and sets the transponder to squawk 7700 (mayday signal).

Simultaneously, Autoland analyzes terrain, weather, and nearby airports to determine the optimal airport for landing given performance characteristics, winds, runway length, available range, and a host of other factors. It controls speed, altitude, and flight path and manages throttles, flaps, cabin pressurization, and more.

The system can be turned off if the pilot comes by pressing the button again.

On the other hand, an airplane needs the most recent G3000 flight deck, with auto-throttles, auto-braking, radar altimeter, and other features, to have Autoland.

Moreover, fitting the system to the private plane is prohibitively expensive. Garmin declines to price Autoland [110].

2.2.9.2 De-icing Sensors

De-icing is essential for airplanes for security reasons. Ice and snow increase the weight of the airplane and changes its aerodynamics.

Although the ice detection and quantification on airplanes have not been sufficiently solved yet, the ONA eVTOL will install both the Magnetostrictive Ice Detector (MID) and the Optical Ice Detector (OID) from Collins Aerospace.

Those sensors reduce significantly the environmental impact because they reduce the need for ice protection system (IPS) operation, and thus, reduce fuel consumption.

The OID can provide real-time information quantifying the severity of the icing condition, allowing the IPS to apply only the exact power needed to maintain ice-free critical surfaces instead of applying “full-on” power every time [69].

They will be located at the engine cowls and the wings. The ice detectors look like the one seen in Figure 57:



Figure 57. Collins Aerospace Ice Detector [69]

2.2.9.3 Sound Sensors

Although these sensors are still under development by Dutch and U.S. researchers, they will be very interesting for the eVTOL in the future.

This type of sensor, also called Acoustic Vector Sensor (AVS), can alert pilots about other aircraft within about 10 kilometers. It listens for sounds that are passed to a small personal computer and then alerts the pilots [70].

2.2.10 Weight & Cost Estimation

As the project is in development, the price of each sensor has been researched, its weight, and how many of them are needed. Some of the prices are not accessible through the internet, so a request to the company provider has been done. Some providers answered while some others did not. However, an estimation of the cost and weight has been done with the available information.

More than 300 sensors will be needed. The price estimation without some of the prices due to unanswered requests is around 550,000€. The total weight of all the sensors needed is around 85 kg.

In Table 2, a summary of all the sensors specified in the section above can be found (Request means it has been requested without any answer). Please find in [APPENDIX A](#) the weight and cost estimation table with all the sensors.

2.3 Internal Communications Network System

Nowhere is the impact of computer technology on commercial aviation more apparent than in modern aircraft cockpit.

A major part of the hydraulic systems, control stick (joystick), and dials and gauges have been supplanted by computer and electric systems represented by a handful of screens in the cabin [76].

These systems need an internal communications network system in order to work properly. Information from all the antennas and sensors must be transmitted to the computers to be processed and later shown on the screens.

First, an explanation of all the computer systems that aircraft have is going to be written. Later, the communication network system will be explained in detail.

2.3.1 Flight Management System (FMS)

The highest level of automated flight system is the FMS. FMS is onboard multi-purpose navigation, performance, and aircraft operations master computer designed to provide virtual data and operational harmony between closed and open elements associated with a flight from before engine start and T/O, to landing and engine shutdown.

It operates the aircraft with greater precision than possible by a human pilot alone, coordinating the adjustment of flight, engine, and airframe parameters either automatically or by instructing the pilot how to do so.

The main component of an FMS is the FMC. It communicates with the EICAS, the ADC, the EFIS, the Automatic Flight Control System (AFCS), the Aircraft Health Monitoring System (AHMS), the Inertial Reference System (IRS), the

collision avoidance systems, all the radio navigational aids, and the Fly-by-Wire Digital Flight Control System (DFCS) via data buses [77].

In Figure 58, the structure of the FMS is shown:

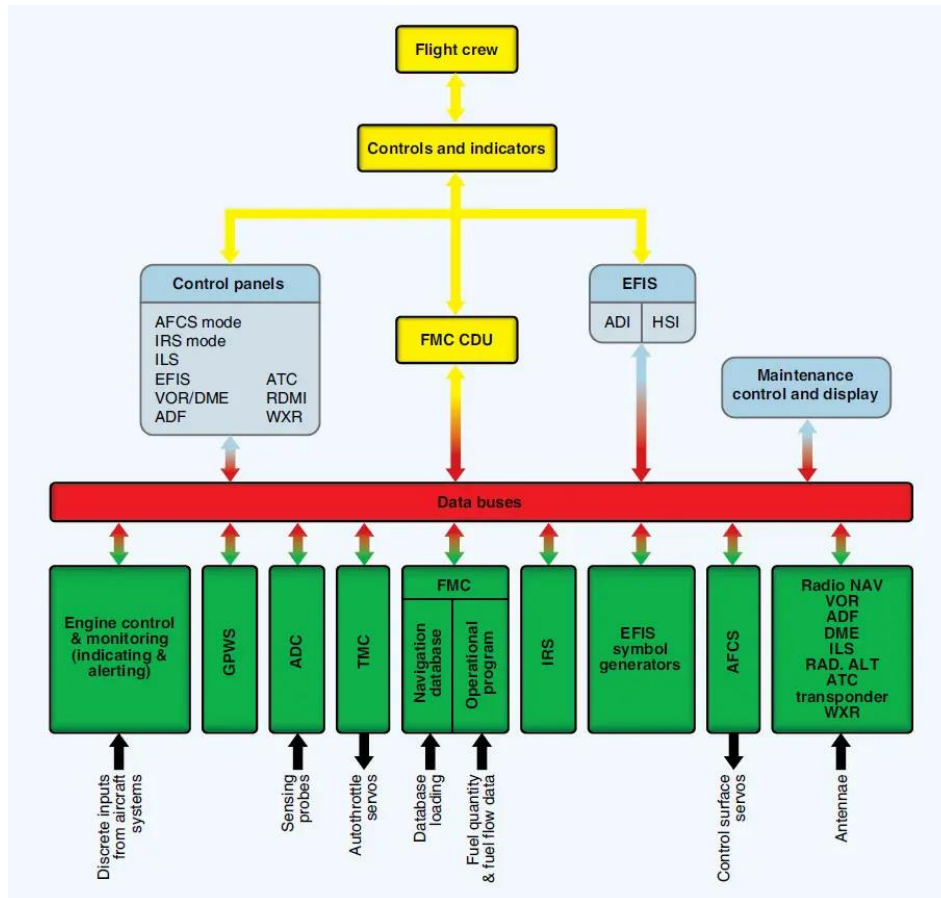

Figure 58. FMS Subsystems Structure [77]

Two separate FMCs are used in a typical FMS. However, they do crosstalk through the data buses. If one of the main components fails, the remaining operational units continue to operate with full control and without system compromise. They will be under the cockpit cabin seats.

The FMC has stored in its database hundreds of flight plans with predetermined operational parameters that can be selected and implemented. Integration with Navigational-Communication (NAV-COM) aids allows the FMS to change radio frequencies as the flight plan is enacted. Weather and traffic considerations are also integrated. The FMS can handle all variables automatically. However, it communicates with the pilot to present its planned action, gain consensus, or ask for one input or decision.

2.3.1.1 Engine Indicating & Crew Alerting System (EICAS)

In our case, the EICAS will be one of the glass cockpits of Garmin. The G3000 integrated flight deck can be seen in Figure 59. It has a very friendly tactile

interface, which comes with a 3-axis autopilot, autothrottle, and automatic stability and descent capabilities.

It will be used for monitoring and displaying engine information and aircraft system information to the pilot. The cost of the system is around 500,000€, maybe more because Garmin does not give the price.

In the event of a malfunction, it will display the fault and may also display the appropriate steps for remedial action [78].



Figure 59. Garmin G3000 Glass Cockpit [177]

2.3.1.2 Air Data Computer (ADC)

ADCs are an essential avionics component found in modern glass cockpits. They receive data from various sensors located remotely around the aircraft (total air temperature probe, AOA, and pitot-static pressure system).

Once data is received, ADCs process the inputs, and apply some compensating factors to calculate very precise altitude, indicated airspeed, true airspeed, Mach number, and static air temperature.

The output data is usually sent to other aircraft systems and flight control computers that will use it.

This computer system is very important for providing the data necessary for safe and effective aircraft operation in automated control systems and aircraft [79].

As before, Garmin will provide its air data computer. Model GDC-74H Air Data Computer will be installed in the eVTOL. The model can be seen below in Figure 60, and it costs around 4,800€.



Figure 60. Garmin GDC-74H Air Data Computer [178]

2.3.1.3 Electronic Flight Instrument System (EFIS)

EFIS is a type of flight deck instrument display system that uses electronic rather than electromechanical display technology. EFIS normally consists of a PFD, an MFD, and an EICAS display.

It displays all the information that the pilot requires to determine basic flight parameters (airspeed, altitude, rate of climb...), the autopilot status, the auto-throttle engagement status, Flight Director (FD) modes, headings, bearings, maps, weather information... and even more information according to the design.

In modern systems, only one multifunctional display unit is used [80]. In our case, the glass cockpit of Garmin will be this multifunctional display unit.

2.3.1.4 Automatic Flight Control System (AFCS)

The AFCS is a single system that integrates an aircraft autopilot with many features and various autopilot-related systems such as the FD.

AFCS nowadays is capable of almost everything thanks to the extent of programmability, the level of integration of navigational aids and AHRS, the integration of FD and autothrottle systems, and the combining of the command elements of these various systems into a single human interface.

AFCS receives sensor information from other aircraft systems. Depending on whether the aircraft is under autopilot or manual control, the AFCS will either automatically move and control the aircraft's flight control surfaces or display FD commands for the pilot to follow to achieve the desired status [81].

Garmin has an AHRS-based AFCS perfect to offer exceptional flight automation, precision, and value on a wide spectrum of aircraft. The GFC 700 will be installed in our aircraft, at a cost of around 35,000€. It is a digital autopilot with the interface seen in Figure 61:



Figure 61. GFC 700 Garmin Digital AFCS [179]

2.3.1.5 Aircraft Health Monitoring System (AHMS)

AHMS is a predictive maintenance tool consisting of a high-capacity flight data acquisition unit and the associated sensors that sample, monitor, and record, information and flight parameters from significant aircraft systems and components.

It is a crucial component of aircraft operations. AHMS makes use of sensor-captured data in real-time to improve reliability and safety and cope with potential concerns as soon as possible.

AHMS consists of hardware and software instruments, solutions, and techniques that conduct remote aircraft surveillance to learn their present potential serviceability, significantly reducing inspection time.

AHMS uses different technologies: Fault Diagnostic System (database), AI, and a wireless sensor network [82].

The eVTOL will have installed the FLYHT's Automated Flight Information Reporting System (AFIRS). This FLYHT AHMS offers reliable, future-proof, voice data connectivity with 5G and SATCOM, along with backward compatibility with 3G and 4G/LTE [86].

2.3.1.6 Inertial Reference System (IRS)

The IRS is a key component of an aircraft's inertial navigation system which is usually combined with a GPS receiver and sensor fusion software.

It constantly supplies safety-critical position and attitude data to the aircraft flight controls, avionics, and mechanical systems even when GPS signals are not available.

IRS uses gyroscopes, accelerometers, and electronics to provide data on linear and angular acceleration, linear and angular velocity, position, attitude (roll, pitch, and yaw), platform azimuth, the magnetic and true heading, altitude, body angular rates, and more [83].

2.3.1.7 Collision Avoidance Systems (CAS)

The several CAS systems that will be installed in the eVTOL have been already explained in previous chapters ([2.1.2.1.7](#) & [2.2.9.1](#)).

As described, a TCAS system and a robust DAA system will help the aircraft not to crash with other aircraft or other objects such as buildings, cars, and trees...

2.3.1.8 Fly-by-Wire Digital Flight Control System (DFCS)

A Fly-by-Wire system is used by modern flight control systems. Fly-by-Wire is a modern flight control system that has replaced manual flight controls with an electronic interface. It uses the FMC to process the flight control inputs made by the pilot or autopilot and send the corresponding electrical signals to the flight control surface actuators (rudder, elevators, ailerons, flaps, and engine controls).

The Fly-by-Wire DFCS can receive and interpret simultaneous input from multiple sensors and after a processing time, it provides computerized controls used to stabilize the aircraft and adjust the flying characteristics without the pilot's involvement in real-time [84, 85].

However, it is possible that later the eVTOL accepts Fly-by-Optical (with optical fiber) or 5G communications.

2.3.1.9 Ground Proximity Warning System (GPWS)

The GPWS generates advisory alerts and mandatory response warnings to the flight crew whether the aircraft is in immediate danger of flying into the ground or an obstacle. The pilot, therefore, is required to take a specific action.

Nowadays, more advanced systems known as Enhanced Ground Proximity Warning Systems (EGPWS) are installed.

The system monitors an aircraft's height above ground as determined by a radar altimeter. Combined with a worldwide digital terrain database and the reliability on GPS technology, computers keep track of the readings, calculate trends, and warn the flight crew.

Nowadays, there exists a terrain display at the PFD that gives visual orientation to high and low points nearby the aircraft to the pilot [189, 190].

The system will be installed with the G3000 cockpit systems.

2.3.2 Communications Network

To interconnect all the antennas and sensors with the different FMS subsystems and these subsystems with the glass cockpit and with the pilots and flight control systems, a communication network is needed.

This communication network is called Aeronautical Telecommunication Network (ATN) and the aeronautical community defined its architecture based on the standard of the International Standards Organization (ISO), using the Open Systems Interconnection (OSI) model in a bus network architecture.

However, evolution to new communication systems is happening, and the transition to 5G or optical fiber may be the future.

In this section, some of the possible technologies used in aircraft for communication networks, their main characteristics and which will be installed in the airplane, and possible future changes are explained.

2.3.2.1 CAN Bus

The Controller Area Network (CAN) – CAN bus is a robust bus standard designed to allow the Electronic Control Units (ECUs), which are the microcontrollers and other devices, to communicate with each other in applications in a reliable, priority-driven way without a host computer. CAN bus is supported by a rich set of international standards under ISO 11898.

It has its origins in the automotive industry. Robert Bosch installed the CAN bus first in Mercedes-Benz cars to save on copper [87].

2.3.2.1.1 CAN Working Principle

Devices connected to a CAN bus are called Line Replaceable Units (LRUs) or “nodes”. Each LRU consists of a Central Processing Unit (CPU), CAN controller, and a transceiver, which adapts the signal levels of both data sent and received by the node.

CAN bus is a broadcast-type bus. The data, which is sent as a frame, is transmitted by one LRU and received by all LRUs connected to the bus, including the LRU that sends the frame. Data frames do not contain a Source Address (SA) or Destination Address (DA), the data is sent onto the network.

The message is identified by a network-wide unique identifier in each frame. Each LRU will have a filter to accept or drop the frame.

All nodes can send and receive data, but not at the same moment. CAN data transmission employs a lossless bitwise arbitration method of contention resolution. This method requires all nodes to be synchronized to sample every bit at the same time.

However, as data is not transmitted with clock data, it is not a synchronous bus [87].

2.3.2.1.2 CAN Main Characteristics

It operates at data rates up to 1 Mbps (high-speed CAN) for cable lengths less than 40 m. For longer cable lengths (500 m), the data rate falls to 125 Kbps (low-speed CAN).

However, the latest version of CAN introduces a flexible data rate, more data per message, and much higher speed transmissions. It has increased the data length to 64 Bytes, 800% more. In addition, the maximum data rate has also been increased to 8 Mbps. Each ECU can dynamically change its transmission rates and select the message size, based on real-time requirements.

Normal data signal transmission uses a twisted pair of wires (shielded or unshielded). Optical fiber can also be used.

Data collisions on the bus are avoided using the Carrier Sense Multiple Access with Arbitration based on Message Priority (CSMA/AMP). It ensures that a terminal will transmit only when the bus is quiet. Bus arbitration logic links a terminal to a higher-priority message if two or more terminals attempt to transmit at the same time.

Usually, no more than 32 terminals are connected to the bus to avoid data delay. The data encoding is Non-Return to Zero (NRZ) with bit stuffing.

The ISO has specified ISO 11898 for high-speed CAN buses and ISO 11519 for low-speed CAN buses [87].

In Figure 62, the OSI layers that the CAN bus uses, and its physical implementation are represented:

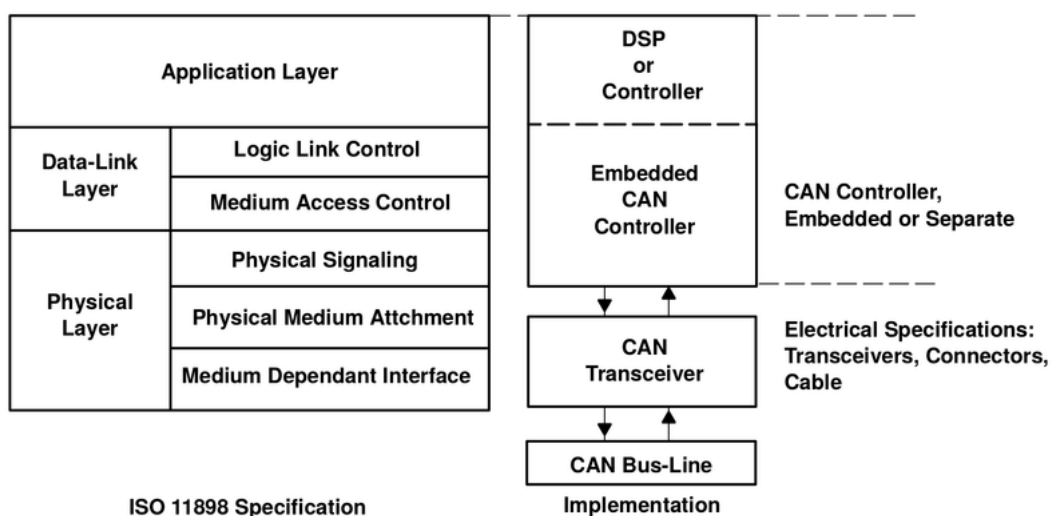

Figure 62. CAN bus OSI layers and Physical Implementation [88]

2.3.2.1.3 CAN Limitations

CAN bus has a limited number of nodes and a limited length to work at high speeds, and it is likely to have undesirable interactions between nodes.

The cost of software development and maintenance is high [88].

An attacker can attach a device to inject false measurements and communicate them to the pilot in small aircraft. However, these attacks require physical access, something that is highly regulated and controlled in the aviation sector [89].

2.3.2.2 ARINC 664 Part 7 Bus

Avionics Full-Duplex Switched Ethernet (AFDX), also called ARINC 664, is an Aircraft Data Network (AND) patented by international aircraft manufacturer Airbus, for safety-critical applications that utilize dedicated bandwidth while providing deterministic Quality of Service (QoS).

AFDX is based on Ethernet technology, being AFDX a deterministic protocol for real-time application on Ethernet media. It is a specific implementation of ARINC Specification 664 Part 7, a profiled version of an IEEE 802.3 network.

Full-duplex, redundancy, determinism, high-speed performance, switching, and profiled networks are the six main features of an AFDX data network [90].

2.3.2.2.1 ARINC 664 Working principle

AFDX uses a special protocol to provide deterministic timing and redundancy management providing guaranteed bandwidth and QoS, and secure and reliable communications of critical and non-critical data. The possibility of transmission collisions is eliminated.

The main elements of an AFDX network are end systems, switches, and links.

The end systems or LRUs perform traffic policing, integrity checking, and redundancy management on a Virtual Link (VL) basis. They communicate with traffic shaping by use of Bandwidth Allocation Gaps (BAGs). BAG is the maximum rate data can be sent. There must be enough bandwidth for other VLs without exceeding 100 Mbps of total speed. BAG values in milliseconds (ms) are: 1, 2, 4, 8, 16, 32, 64, 128. The jitter is also defined and limited.

AFDX switches incorporate functions for filtering and policing, forwarding (based on configuration tables), end system, and network monitoring.

The links are used as many VLs. A VL defines the unidirectional connection from one source end system to one or more destination end systems. Bidirectional communications must therefore require the specification of a complementary VL. Each VL is allocated dedicated bandwidth.

As AFDX uses full-duplex Ethernet, two separate pairs or strands for transmitting and receiving the data are used.

AFDX is being used as the backbone for all systems including flight controls, cockpit avionics, air-conditioning, power utilities, fuel systems, landing gear, and others... [91]

2.3.2.2 ARINC 664 Main Characteristics

AFDX is a serial data bus, although is more like a communications network. It is a CSMA/CD protocol implemented as a star topology. ARINC 664 Part 7 is based on 10/100 Mbps switched Ethernet technology (IEEE 802.3) Media Access Control (MAC¹) addressing, Internet Protocols (IP), and User Datagram Protocol (UDP), with special protocol extensions and traffic management. Data is transmitted over a copper or fiber transmission medium.

AFDX is a deterministic network, which guarantees the bandwidth of each logical communication channel, called a VL with traffic flow control. The transmission delay and jitter are constrained and specified.

It is a full-duplex network. Each end system has two twisted pairs of copper wires, one to transmit (Tx) and one to receive (Rx). Packets are received First-In, First-Out (FIFO) at the Tx and Rx buffers.

AFDX is implemented as a dual redundant network. Each data frame is transferred in two independent data paths, ensuring the reliability and availability of the AFDX standard.

Transmission corruption is detected in the switch using the frame check CRC sequence with an integrity check.

Moreover, all these characteristics make AFDX ensure a BER as low as 10^{-12} while providing bandwidth up to 100 Mbps [90, 92].

The following OSI reference model levels are where it describes interoperable functional components (See Figure 63):

- DATA LINK: MAC¹ and special AFDX features
- NETWORK: IP and ICMP
- TRANSPORT: UDP and TCP (optional)
- APPLICATION NETWORK: Sampling, queueing, SAP, TFTP, and SNMP

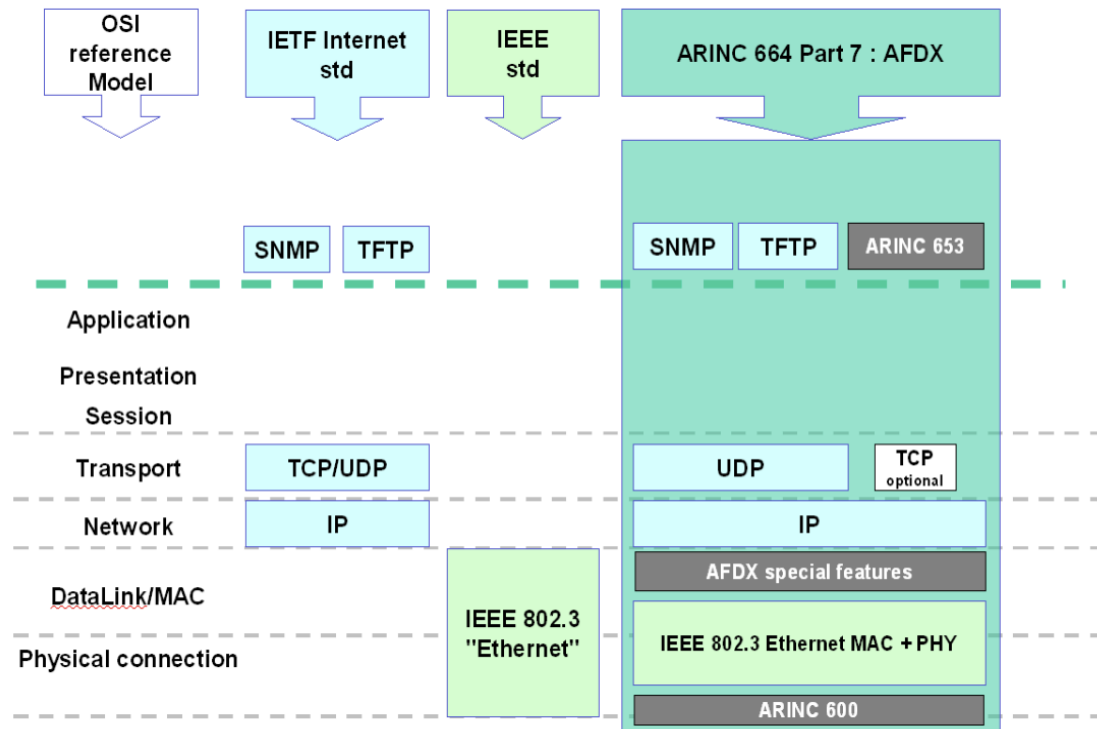

Figure 63. OSI Layers AFDX [90]

2.3.2.2.3 ARINC 664 Limitations

Aircraft electronic subsystems usually adopt different communication protocols to meet the requirements of different communication data characteristics, which increases complexity as well as cost in system design and overwhelms bandwidth limitations.

In AFDX, the IP/UDP and Ethernet are used and only slight alterations to the individual data structure are applied, which lowers the bar for designing hardware and developing software in avionics considerably [94].

Moreover, from the global avionics communication architecture point of view, AFDX necessitates the update of the end systems at the application layer to enable a consistent mapping between VL identifiers and the appropriate priority level. This may imply extra costs [93].

2.3.2.2.4 CAN bus VS ARINC 664 bus

As nowadays the most common communication buses are the CAN and the ARINC, a comparison table (See Table 2) has been written to check their differences:

	CAN bus	ARINC 664 Part 7 bus
Data bus cable	Shielded or Unshielded Twisted Pair (STP or UTP)	STP or Optical Fiber
Data rate	High speed 1 Mbps Low speed 125 Kbps	10/100 Mbps
Data encoding	NRZ-Bipolar	RZ-Bipolar
Data transmission	Data transmitted in frames	Data transmitted in Ethernet frames
Error detection	3 methods at the message level 2 methods at the bit level	2 methods at the message level 1 method at the bit level
Data direction	Bidirectional bus Nodes can receive and send data to the bus	Bidirectional Full-Duplex bus Dual-port both transmitting and receiving the same data
Number of nodes	Up to 32	Several nodes
Data width	Up to 64 bits	1,518 Bytes

Table 2. Comparison between CAN bus and ARINC 664 bus

2.3.2.3 Optical Fiber

Optical fiber technology has found increased applications with the passage of time. It offers numerous advantages over conventional technologies.

Years ago, Fly-by-Wire technology brought about a revolution to fight control systems in aircraft. Nowadays, optical fiber technology is seen as the next generation of in-flight control systems. It added a new dimension to aircraft control systems in the form of a Fly-by-Light control system.

The use of fiber optics is gaining momentum in modern avionics because it helps to solve the Size, Weight, and Power (SWAP) challenges in next-generation system designs.

Optical fiber can handle high-bandwidth applications, weighs less than copper wire, is more immune to Electro-Magnetic Interference (EMI), and is more reliable.

Fiber optic connectors and manufacturers are innovating to enhance cockpit management and revolutionize aircraft cabin design. Achieving cost-effective solutions and formulating standards for this technology are vital [95].

Comparing optical fiber with copper, the first one offers many more benefits (See Table 3):

	Optical Fiber	Copper
Bandwidth	60 Tbps	10 Gbps
Weight	5.95 g/m	58 g/m
Signal Integrity Amplifier	Every 48 km approx.	Every 4.8 km approx.
Immunity to EMI	YES	NO

Table 3. Comparison between Optical Fiber and Copper

2.3.2.4 Technology 5G

5G underlying capabilities (Enhanced Mobile Broadband (EBB), Massive Machine Type Communication (MMTC), and Ultra-Reliable Low Latency Communication (URLLC)) are ideal for business-critical applications.

5G is an ecosystem play where multiple technologies complement and converge. With its vast capabilities, 5G could enable industrial Internet of Things (IoT) functions to finally realize their potential.

It is a fact that 5G will take the aviation industry to new heights, from airports and airlines to manufacturers and passengers [96].

- Airports:
 - QR codes scanning for a passenger identity check at departure gates
 - 5G enabled drones for airport security
 - Holographic advertisements and exhibitions
 - Automated airport ground handling
 - Robotized baggage handling
- Manufacturing:
 - Adaptive process control
 - Digital twin and connected blocks
 - Real-time remote simulations

- Passengers:
 - Passenger facial recognition
 - In-flight private 5G network for internet services
 - Virtual guided tours for passengers
 - AI-assisted computer vision to scan boarding gate areas
- Airlines:
 - In-flight connectivity
 - **High bandwidth and reliability for avionic systems**
 - Electric air taxis and drones
 - Baggage control and monitoring

The avionic systems inside airlines can have accelerated communication with control towers upon landing via highly reliable 5G connectivity. Moreover, real-time equipment monitoring using 5G networks can enable predictive maintenance. Communication between sensors and antennas could be much faster [96].

However, the new generation of commercial wireless communications of 5G and the multiplication of 5G antennas have raised concerns about interference with aircraft operations, particularly for landing airports.

The FAA has issued a warning that such tampering may seriously impair low-visibility operations and harm delicate airplane equipment like altimeters.

Independently, all available data demonstrates that 5G networks operating in the 3.7 to 3.98 GHz band do not interact with aviation equipment operating in the 4.2 to 4.4 GHz band [97].

Although nowadays there is a lot of confusion about 5G, air traffic, and safety, it is a fact that 5G will be the future of aviation and the main strategic pillars will be:

- **Safe and uninterrupted airline operations:** Any spectrum deployments should not have a strong influence on civil aviation.
- **Cooperative coordination:** Government authorities should collaborate with industry parties to arrange spectrum deployments
- **Establishing a predictable global spectrum environment and safeguarding civil aviation spectrum resources**

- **Robust avionics and airplane design** with an obvious and affordable migration route [98]

Regarding the field of eVTOLs, 5G could serve as a medium for data and information sharing between drones or electric air taxis, air traffic, and wireless network service in the future.

2.3.2.5 Technology Selection

After describing the actual trends of communication networks in aviation, the eVTOL will have installed at first an ARINC 664 or AFDX bus due to its main characteristics and few drawbacks.

However, time will make space for optical fiber and 5G, not only on the aircraft but also in the aviation world.

2.3.3 Cost Estimation

As the project is in development, the price of each system has been researched. The price of the AHMS is not accessible through the internet, so a request to the company provider has been done without any answer. However, an estimation of the cost has been done with the available information.

In Table 4, some of the FMSs explained before can be found (Request means it has been requested without any answer). The IRS and the CAS systems work with the information received from the sensors explained in previous sections, so there is no specific system.

System	Model	Price (€)	Provider
EICAS	G3000	~500,000	Garmin
ADC	GDC-74H	~4,800	Garmin
AFCS	GFC 700	~35,000	Garmin
AHMS	FLYHT AFIRS	Request	FLYHT
Communication Network	ARINC 664, optical fiber, 5G, CAN bus	5,000 – 10,000	Different Providers
TOTAL		~549,800*	

Table 4. Summary of all the FMS with their prices

***Price without the “Request” ones**

CHAPTER 3. COCKPIT DESIGN FOR SINGLE-PILOT INSTRUMENTAL FLIGHT RULES (SPIFR)

3.1. INTRODUCTION

The term SPIFR refers to safely operating an aircraft with just one pilot in the cockpit assisted by advanced onboard automation and ground operators providing flight support services well beyond those currently delivered by aircraft dispatchers.

The main reason to design the eVTOL for a SPIFR is to have cost savings for the crew and the possibility to use the copilot seat for a passenger. Moreover, in the future, the intention of the project is that the aircraft can fly without a crew, just passengers, like a UAV.

However, a key requirement for single-pilot airplanes is to maintain safety at a level no less than current two-pilot operations. To do so, the introduction of advanced cockpit automation and new ground operator positions using support tools and air-ground communication tools is needed [99].

In this section, an exhaustive study of all the requirements for single-pilot operations and the cockpit design is done.

3.2 SINGLE-PILOT IFR

3.2.1 Legal Requirements

Flying with just one pilot can be a very tough and busy task due to the amount of workload flying an airplane. For this reason, in order to maintain safety, some legal requirements have been settled down. As the project is going to be initially for the European sky, a study of the legal requirements for SPIFR has been done regarding the European regulation.

In Europe, the main body that writes down the sky regulation is the European Union Aviation Safety Agency (EASA). The main purpose of EASA is to unify the common airworthiness standards in the Member States of the European Union and to ensure environmental protection in civil aviation [100].

The first thing to have a SPIFR aircraft is to have a licensed pilot. The pilot must have a valid single-pilot Instrument Rating (IR) license from EASA to fly a SPIFR aircraft in Europe.

EASA nowadays is simplifying the rules to enable General Aviation (GA) pilots to carry out competency-based training that focused on the specific risks associated with flying IFR with single-pilot aircraft. This type of license must be renovated every 12 months.

Regarding the aircraft, EASA establishes a rule. The rule is defined in the EASA EU-OPS (European-Operations) regulation with rule reference number 1.655.

The name of the rule is “**CAT.IDE.A 135: Additional equipment for single-pilot operation under IFR**”, and it states [101]:

“Airplanes operated under IFR with a single-pilot shall be equipped with an autopilot with at least altitude hold and heading mode”

Although the legal requirements are those just mentioned, in order to maintain safety and reduce pilot workload and have a reliable SPIFR flight, the study of the necessary cockpit equipment is explained in the next section.

3.2.2 Design Requirements for the eVTOL

Safety is the main factor why a SPIFR flight is questioned. Although most pilots agree that an experienced and competent copilot enhances the safety of IFR flights, thousands of SPIFR trips are completed safely every day.

Safety in SPIFR depends on many factors: the level of safety, the money invested, and the effort invested. Human and equipment variables must be explored.

The main problem is pilot workload, aggravated by the need of multitasking. In SPIFR, the pilot also serves as a navigator, radio operator, systems manager, onboard meteorologist, record keeper, and sometimes, flight attendant. Some studies have shown that once the pilot starts juggling more than three to five tasks, accuracy and effectiveness deteriorate rapidly [104].

Therefore, having a great cockpit design with all the necessary equipment and a professional autopilot is needed. This is important because, in SPIFR, complexity has reached the point where there is a crew of two: the pilot and the autopilot. The pilot must learn to fly the airplane through the autopilot and understand and use all the new cockpits installed.

In the next section, a description of the required equipment for SPIFR is deeply explained.

3.2.2.1 Required Cockpit Systems

There is nothing worse than launching into instrument conditions flight with poor quality equipment that does not work properly. A panel with equipment that would be acceptable for low-density Visual Flight Rules (VFR) operations may be completely inappropriate for the IFR environment!

Nowadays, the minimum IFR equipment is usually considered to be dual NAV/COMM, an audio panel with a marker beacon receiver, and a transponder

with Mode C. Many pilots would add at least a yoke-mounted GPS as a supplement to the approved IFR equipment.

However, these are not enough for SPIFR operations. Here are some other items that can greatly reduce pilot workload and that are highly recommended for SPIFR:

3.2.2.1.1 High-Quality Navigation & Communication Radios

The aircraft will be equipped with many radio communication and navigation antennas that are high-quality. These antennas have been already explained in section [2.1.2](#). With all of them, the aircraft is prepared to have high-quality navigation and communication systems that will work correctly and precisely.

3.2.2.1.2 Headset & Push-To-Talk Switch

Communication is absolutely critical up in the air. Missed radio calls and poor-quality radio transmissions hamper the pilot's ability to communicate effectively, which raises both pilot and ATC workload when transmissions must be repeated.

Good quality aviation headsets make all the difference during communication with the tower and other aircraft. The ability to talk without reaching for a hand microphone eliminates a major distraction. A headset provides clearer audio reception, minimizing missed or misunderstood transmissions [104].

In order to choose a headset, some factors have been considered: passive and active noise reduction, comfort, and a good microphone.

The best all-around headset is the "*Bose A20 Aviation Headset*" (See Figure 64).



Figure 64. Bose A20 Aviation Headset [180]

This headset gives 30% greater noise reduction than conventional aviation headsets. It weighs only 340 grams, being one of the lightest and most comfortable aviation headsets.

For specialized GPS and traffic warning systems, it offers an ergonomic control module with additional audio input and intercom/Aux priority toggling. A customized audio prioritizing control with "mute" and "mix" options is also included.

There is a model that also includes Bluetooth connectivity for taking calls or listening to music.

The price of this headset is around 1,000€ [108].

3.2.2.1.3 Autopilot

The need for an autopilot slaved to a heading bug is invaluable for keeping the plane's right side up and going in the proper direction while the pilot reads charts, copies revised clearances, tunes radios, etc.

Altitude-hold and coupling and wing leveler features are wonderful added benefits. The autopilot must be fully and seamlessly integrated into the airplane and its navigation systems, and the complete autopilot system must be functional for every flight with only one pilot.

Fatigue is very much a consideration in SPIFR. Flights in tough weather where the pilot must not only manage the system and hand fly the aircraft raises the risk level. Single-pilot charter flights are required by the regulations to have a fully functional autopilot for IFR dispatch.

In the eVTOL, as mentioned in section [2.3.1.4](#), the autopilot will be the AFCS from Garmin which is AHRS-based. The model is the GFC 700. It can automatically move and control the aircraft's flight control surfaces or use the FD to display commands to the pilot to achieve the desired status.

3.2.2.1.4 GPS/DME

Some means of measuring distance will be useful for maintaining situational awareness. Before GPS, DME was the standard for measuring horizontal distance. Today, GPS has largely taken over DME functions.

As explained in sections [2.1.2.1.2](#) (DME) and [2.1.2.1.5](#) (GPS), the aircraft will have installed both DME and GPS antennas in order to maintain the aircraft's situational awareness.

3.2.2.1.5 Hand-held Communications Radio & Hand-Held GPS

A hand-held communications radio with GPS can help the pilot to obtain clearances before the engine start, save fuel when experiencing ATC ground delays, get weather reports, and listen to the Automatic Terminal Information Service/ Automated Weather Observation System (ATIS/AWOS) on the way to the airport.

The best hand-held in the aviation market right now is the Yaesu FTA 750L Hand-Held VHF Transceiver/GPS (See Figure 65).



Figure 65. Yaesu FTA750L Hand-Held VHF Transceiver/GPS [109]

This hand-held radio is very good and easy to use. It is very compact, and it still manages to be a full-spectrum NAV/COMM radio. The best reason to use this one is its full-dot matrix display. It also has waypoint navigation and GPS logging features. It can store up to 200 memory channels with 15 alphanumerical characters. The cost is around 400€ [109].

3.2.2.1.6 Backup Power for Flight Instruments

Losing primary flight instruments in Instrument Meteorological Conditions (IMC) is a major emergency. The aircraft will be equipped with an alternate power system.

The instruments will be capable of functioning independently from the primary power source.

3.2.2.1.7 Others

If the budget allows, some other systems may be added to the aircraft:

- **Electric Trim:** Everything will be fly-by-wire, so the trim will be electrically actuated.

- **Horizontal System Indicator (HIS):** combines a heading indicator with the VOR/ILS display.
- **CAS:** already explained in section [2.3.1.7](#).
- **Weather Datalink:** For weather radar images and reports beamed directly to the cockpit (installed with the weather radar and ADS-B antennas).
- **WAAS-enabled GPS:** The GPS system allows WAAS for better situational awareness.

Most pilots enjoy gadgets, and these can contribute to reducing the workload while providing more information and avoiding distractions.

3.2.2.2 Requirements for SPIFR Operations

Many of the requirements for SPIFR operations are obvious. The cockpit organization is crucial, meaning that controls, switches, and essential items must be located so the pilot can easily see and reach them. The design of the basic controls is also crucial so the hands of the pilot are not busy all the time. This is the reason why a fully integrated glass cockpit FMS has been selected.

The degree of automation in the systems and avionics is much more crucial. The autopilot will be utilized almost exclusively during flight, except for takeoff and landing, thus it must be simple to use and perform essential tasks such as automated height acquisition [103].

For these reasons, the systems, antennas, and sensors explained in the previous chapters are technologically advanced and well-prepared for SPIFR.

Furthermore, technology nowadays is playing an increasingly important role in the cockpit and can manage many of the responsibilities usually handled by the person in the right seat, serving as a digital copilot.

For SPIFR, an iPad running some Electronic Flight Bag (EFB) aviation Apps is used to provide contextual information before and during a flight, calling out abnormalities or deviations and assisting with duties during high-workload phases of the flight.

The iPad can also be used to get organized, managing all the information the ATC gives the pilot (altitude changes, heading changes, clearance updates, frequencies...)

There are some Apps, like Garmin Pilot and ForeFlight, which offer a robust set of alerting features. They can provide visual and aural alerts when approaching nearby terrain or obstacles, ADS-B traffic, approaching nearby airspace, and active Temporary Flight Restrictions (TFRs). The ForeFlight App can display the

ATIS or AWOS frequency when approaching the destination and even call out which runway the plane is lined up with on the final approach.

Moreover, the Apps can automatically display the airport diagram with an overlay of the aircraft's position after landing due to airport recognition. This can save the pilot from head-down time searching for the chart in the App [106].

3.2.2.3 Preparation Before Flight

Even before departure, IFR flights can be time-consuming, especially in conditions with complicated weather. Preparation keeps problems from compounding when the unexpected happens.

Thorough planning should be simple with computerized flight planning, internet airport directories, and literally hundreds of weather sources. However, sorting and making sense of it all can be challenging [104].

Prior to leaving the parking area and engine start, the pilot should [102, 105, 106]:

- Obtain clearance, indicate the course on the map, load the radio frequencies for navigation, and program the GPS flight plan with the course
- Perform a predicted Receiver Autonomous Integrity Monitoring (RAIM), a technique used in GNSS receivers to evaluate the consistency of the GNSS signals being received at any given moment.
- All route and approach charts should be taken out and folded. If the pilot receives a last-minute approach modification, there is usually little time to search for fresh charts

In case the aircraft has an iPad with Garmin Pilot and ForeFlight Apps, here are some things to do before flight [106]:

- Enter personal weather criteria to Garmin Pilot App (maximum surface winds, minimum ceiling, and visibility). The App will check the weather forecasts for airports in the flight plan and alert when the weather exceeds those limits.
- ForeFlight can automatically retrieve the IFR clearance at major airports. So it is good to have it downloaded.
- Look at the iPad Apps settings page to review the alerts and verify they are enabled and that the alert audio option is enabled too.
- Pair the iPad with the headset via Bluetooth to not miss the alerts.

Here there are two images (See Figure 66) that show the App interface of Garmin Pilot and ForeFlight Apps:



Figure 66. Garmin Pilot & ForeFlight App Interfaces, respectively [181, 182]

Having the legal requirements, the cockpit system requirements, and taking these before-flight tips to reduce workload, the airplane is ready for a SPIFR flight.

In the next section, some aircraft that are already certified to fly in SPIFR are described to check for similarities in the cockpit systems with the one the ONA Jet will have installed.

3.2.3 Single-Pilot IFR Existing Aircraft with Garmin Avionics

While most business jets require a 2-pilot crew which increases the operating expenses, several private jet types are certified for single-pilot operations.

Many single-pilot jets have two seats in the cockpit, giving the benefit of having seating flexibility and decreased operating costs when flying in SPIFR.

In this context, Garmin is arguably the most popular provider of avionics systems in general aviation, improving from one year to the next. Some of the most popular single-pilot jets are equipped with Garmin flight decks G1000 and G3000 [111].

As the jet will have the G3000 fully integrated flight deck and other avionics systems from Garmin as well, here there is a list of some single-pilot jets equipped with Garmin:

3.2.3.1 Cessna CJ3+ (Citation Jet 3+)

CJ3+ is the first Citation Jet to be equipped with Garmin's G3000 avionics system. It was certified in 2014, delivering superior reliability without scarifying

productivity and comfort. This aircraft is very similar to the eVTOL, having space to accommodate 1 pilot plus 8 passengers, and a refreshment center up-front that can be replaced by a side-facing seat to maximize passenger capacity.

Garmin's G3000 Integrated Flight Deck avionics offers tactile controls on large format displays. The fully digital dual-channel autopilot system offers system redundancy and safety features and is powered by the Garmin GFC 700 control system (2.3.1.4) [111].

In Figure 67, the configuration of the CJ3+ cockpit is shown:



Figure 67. CJ3+ Garmin's G3000 Integrated Flight Deck [183]

There are almost no buttons but three big touchable screens and two little displays in the central part. The cabin is simple and easy to recognize all the systems and components for the control of the aircraft.

3.2.3.2 Phenom 300E (Prodigy Touch G3000)

The Embraer's Phenom 300E is the best-selling light business jet. Embraer upgraded the aircraft with new cutting-edge technology, including next-generation avionics (Garmin's G3000 Integrated Flight Deck) and a wholly redesigned cabin interior.

Embraer tags the Phenom 300E as "the world's largest, fastest, longest range single-pilot aircraft".

With Embraer's Prodigy Touch G3000, there are still three-panel displays, and many pilots say that the touchscreen controllers at the top of the pedestal are a game changer.

This 6-pax aircraft has a similar cockpit design as the CJ3+ (See Figure 68).



Figure 68. Embraer's Phenom 300E Prodigy Touch G3000 Integrated Flight Deck [184]

The design is not very complex, again without a lot of buttons, touchable screens, and an ergonomic steering wheel, like a video console control.

3.2.3.3 HondaJet Elite (HA-420 with G3000)

Another cutting-edge single-pilot aircraft that makes use of the touchscreen features of the Garmin G3000 cockpit is the HondaJet HA-420. Honda touts its G3000 as being "extremely personalized" with specific upgrades.

One interesting feature of this aircraft is its over-the-wing engines, which displace noise emissions away from the cabin. It has a quiet and spacious cabin suited for long-range travel [111].

The HondaJet Elite can carry 1 pilot and 7 passengers. Its cockpit looks like the one shown in Figure 69.



Figure 69. HondaJet Elite HA-420 with G3000 Integrated Flight Deck [185]

Again, the cabin cockpit is very similar to the ones explained before. This one in particular is almost like the CJ3+ one.

3.2.3.4 Cessna 208B Grand Caravan (G1000)

This heavy-duty aircraft is most often used for cargo missions. In 2008 Cessna replaced its avionics system with Garmin's G1000.

While not equipped with touchscreen capabilities, the G1000 glass cockpit is not much different from the G3000 from a capabilities perspective [111]. In Figure 70, the cockpit of the Cessna 208B Grand Caravan can be seen:



Figure 70. Cessna 208B Grand Caravan G1000 Cockpit [186]

It is observable that this cockpit is less modern than the ones previously seen before. This system has some more buttons and systems that are not on the screens. The steering wheel is also more primitive.

However, with these cockpit functionalities, the aircraft can be flown by a single pilot.

3.2.3.5 Quest Kodiak (G1000)

The Quest Kodiak serves a very similar mission to Cessna's 208B Grand Caravan, so it makes sense that both use nearly identical avionics suites.

However, the Quest Kodiak uses an upgraded version of the G1000, called G1000NXi. Upgrades also include a Flight Stream 510 tablet connection device, an AOA indicator, and a digital standby four instrument group.

The cockpit of the Quest Kodiak can be seen in Figure 71:



Figure 71. Quest Kodiak G1000NXi Cockpit [187]

This system adds a new small screen on the left side. It also incorporates modern processing power that supports faster map rendering and smoother panning throughout the displays.

Moreover, contemporary animations, modernized design for improved readability, and new LED back-lighting are incorporated [111].

Once studied what an aircraft needs to be flown by a single pilot and the aircraft certified for SPIFR that use the same technology installed in the plane, the cabin of the ONA Jet is defined just after the Weight & Cost Estimation section.

3.2.4 Weight & Cost Estimation

As the project is in development, the price of each cockpit system has been researched, and its weight. An estimation of the cost and weight has been done with the available information.

Some of the systems have been explained in previous sections with their characteristics. The high-quality navigation and communication radios will work with the antennas explained in section [2.1.2](#). The autopilot has been explained in section [2.3.1.4](#). The DME ([2.1.2.1.2](#)) and the GPS ([2.1.2.1.5](#)) will work with the information received from the antennas and sensors.

In Table 5, a summary of the rest of the systems specified in the section above can be found:

Cockpit System	Model	Price (€)	Weight (kg)	Provider
Headset & Push-to-Talk Switch	Bose A20	~1,000	0.340	Bose
Hand-Held Comms Radio/Hand-Held GPS	Yaesu FTA 750L	~400	0.450	Yaesu
iPad	iPad Pro 12,9"	~1,200	0.650	Apple
TOTAL		~2,600 *	~1.5	

Table 5. Summary of some of the cockpit required systems price and weight

3.3. FULL GLASS COCKPIT

3.3.1 Glass Cockpit Model

3.3.1.1 Glass Cockpit Definition

A glass cockpit is an aircraft cockpit where flight data is shown on Electronic Flight Displays (EFDs), typically LCD screens, rather than the traditional style of separate analog dials and gauges for each instrument.

A glass cockpit uses several EFDs, such as the PFD or the MFD, which are driven by the FMS and can be adjusted to display flight information as needed. The PFD combines data from several instruments and is the pilot's primary source of flight information. The MFD allows data to be presented on multiple pages that are convenient to switch between.

Glass cockpits offer various benefits:

- Simplification of aircraft operation and navigation, allowing pilots to focus only on the most pertinent information
- Values are easier to read due to the lack of parallax errors and the use of precise numerical values, allowing pilots to interpret more quickly their speed, altitude, position, etc.
- EFDs take less space and show more information
- EFDs are linked to computers which allows data from multiple sources to be processed, resulting in data presented in ergonomic ways and warnings can be more noticeable
- Different layers of information can be presented. Especially useful for the horizontal situation display where weather, terrain, airspace, and other aircraft can be displayed, reducing the risks of entering thunderstorms, CFIT, airspace infringement, and loss of separation.

However, EFDs are vulnerable to electrical system failures and software glitches.

As everything has gone electronic, some flight instruments have progressed as well. The traditional gyroscope has been replaced by electronic AHRS and ADCs, improving reliability and reducing cost and maintenance. GPS receivers are usually integrated into glass cockpits [112].

3.3.1.2 Garmin G3000 Integrated Flight Deck

The Garmin G3000 is an avionics system designed by Garmin Aviation for light turbine aircraft, although it can be installed in the eVTOL. The G3000 Integrated Flight Deck is the first of its class to have an integrated touchscreen system. It contains multiple glass cockpit displays, capable of operating a synthetic vision system, and a three-dimensional displayed rendering of terrain [113].

3.3.2 Garmin G3000 Main Characteristics

3.3.2.1 System Components

The G3000 is an Integrated Flight Control system that uses flat-panel color displays and touchscreen controllers to provide flight instrumentation, location, navigation, communication, and identity information to the flight crew.

The system consists of the following LRUs [114]:

SOME UNITS MAY NOT BE PRESENT IN ALL INSTALLATIONS

To see the details please go to [APPENDIX B](#)

- 3x Garmin Display Unit (GDU)
- 2x Garmin Touchscreen Controller (GTC)
- 2x Garmin Integrated Avionics Unit (GIA)
- 1x Garmin Air Data Computer (GDC)
- 2x Garmin Engine and Airframe Interface Unit (GEA)
- 2x Garmin AHRS (GRS)
- 2x Garmin Magnetometer (GMU)
- 1x Garmin Audio Processor and Marker Beacon Receiver (GMA)
- 2x Garmin Transponder (GTX)

- **OPTIONAL** 1x Garmin XM Weather and Radio Datalink (GDL 69A SXM)
- **OPTIONAL** 1x Garmin Radar Altimeter (GRA)
- **OPTIONAL** 1x Garmin XM Controller (GRC)
- **OPTIONAL** 1x Garmin XM Controller Transceiver (GRT)
- **OPTIONAL** 1x Garmin Wi-Fi Datalink and Flight Parameter Recorder (GDL 59)
- **OPTIONAL** 1x Garmin Iridium Satellite Transceiver (GSR)
- 1x Garmin AFCS Mode Controller (GMC)
- 1x Garmin Airborne Weather Radar (GWX)
- **OPTIONAL** 1x Garmin Data Concentrator (GSD)
- 4x Garmin Servo Actuator (GSA)
- 4x Garmin Servo Gearbox (GSM)
- 1x Garmin Trim Adaptor (GTA)
- **OPTIONAL** 1x Garmin GPS/WAAS Antenna (GA 36)
- **OPTIONAL** 1x Garmin GPS/WAAS and XM Antenna (GA 37)
- **OPTIONAL** 1x Garmin Digital Radio (GDR)
- 1x Garmin TAS Traffic System (GTS 820)
- 1x Garmin TCAS I Traffic System (GTS 850)
- 1x Garmin TAS, TCAS I, TCAS II Processor (GTS Processor)
- **OPTIONAL** 1x Garmin Power Amplifier (GPA)
- **OPTIONAL** 1x Garmin Traffic Antenna (GA 58)
- **OPTIONAL** 1x Garmin PFD Control Unit (GCU)

In order to provide the ONA Jet to be the most ergonomic possible, not all systems will be installed and only the **OPTIONAL**, necessary ones will be installed.

Following this line, the plane will have just one PFD and the MFD will be used as the backup PFD in case the PFD has any failure. This way the weight of the

aircraft is less, and it will be more economic. It will still have the two Touchscreen Controllers.

The rest of the NON-OPTIONAL systems will also be installed.

Regarding the OPTIONAL ones, the radar altimeter of Garmin will be installed, the GRA 55.

The GDL 59 will also be installed in order to provide Wi-Fi connectivity to the systems.

The GSR for having voice and data communication via the Iridium satellite network, which provides connectivity all around the world.

The GDR to have VDL Mode 2 capabilities.

With all these systems, the cockpit will be possible to use for SPIFR.

3.3.2.1.1 System Block Diagram

In order to have the cockpit fully functional, the systems must be interconnected. As there are many systems, a block diagram is attached in [APPENDIX C](#) to understand the architecture and structure.

In this system block diagram, all the systems are defined by their connections, and with the technology used for the connections.

3.3.2.2 Integrated Flight Deck Characteristics

The Garmin G3000 is an innovative cockpit that has many new characteristics:

3.3.2.2.1 Fingertip Control Meets Integrated Flight Deck

Fingertip navigation is a reality nowadays. The Garmin G3000 system is the first touchscreen-controlled glass flight deck ever designed for light aircraft.

It has some great characteristics [113]:

- Bright high-resolution displays with SVT that let the pilot see even in IFR conditions
- Displays divide into two pages to help display multiple systems and sensor information
- Intuitive touchscreen interface which shallows menus and audible feedback

- Automatic Flight Guidance and Control Systems
- Weather, charts, traffic, terrain, and global connectivity options

3.3.2.2.2 Simple, Powerful & Expandable

The G3000 Integrated Flight Deck system revolutionizes the interface between pilot and electronics by [113]:

- Streamlining menu structures
- Eliminating visual clutter
- The replacement of several mechanical switches, buttons, and knobs
- Centralizing data entry in one easy-to-access location gives pilots more focused control with less wasted motion and effort

3.3.2.2.3 A Truly Fully Integrated Flight Deck

The GTC serves as the primary point of entry for the G3000 system. The GTC allows pilots to access more systems and sensors with fewer keystrokes or page sequences because to its desktop-style, icon-driven interface that is based on a revolutionary "shallow" menu layout.

The user interface is all computer software. Configuring certain airframes and avionics setups is made simple by this.

Future system growth possibilities, new improvements, and apps can be easily handled without physically changing the mechanical controls [113].

3.3.2.2.4 Smooth on the Move

Inside the cockpit, finding and accessing functions is made easier by the responsive, icon-identified "touch keys" on the GTC controller.

The GTC screen can be used for full NAV/COMM radio management, streamlined MFD page navigation, remote audio/intercom system control, transponder codes and idents, electronic checklist entries, flight plan entry or edit, plus optional synoptic data and other selected mapping traffic, weather, entertainment, and custom display options.

The GTC also features a single set of mechanical concentric knobs, a volume knob, and a separate map joystick. Each knob's purpose is described on the touchscreen window above it [113].

With all these characteristics, the G3000 Integrated Flight Deck has become one of the main cockpits designed for SPIFR in the Jet market.

3.3.2.3 System Specifications

In this section, the main specifications of the system are explained.

3.3.2.3.1 Screens (PFD & MFD)

Wide Extended Graphics Array (WXGA) high-resolution cockpit monitors of 14,1 inches diagonally give the G3000 an impressively expansive, panoramic view. The displays' expanded 16:9 width to height ratio and 800 pixel resolution. These devices can operate as a PFD, MFD, or both in reversionary mode.

The PFD provides a visual area for the simulated 3D perspective topography as well as enhanced peripheral cues from an extended horizon line (See Figure 72). A rich graphical environment that incorporates the alerting database offers a virtual reality perspective of flight information, ground and sea features, barriers, and traffic. Even solid IFR and nighttime/marginal VFR circumstances allow for its utilization.



Figure 72. Example of what a PFD can show [113]

The MFD provides room for two separate vertical pages to be viewed side-by-side along with the aircraft's engine data. The pilot can use it to show whatever makes sense at any particular point of the flight (charts, traffic, radar, weather...). The high-aspect-ratio displays allow enhanced viewing and management of multiple sensor inputs (See Figure 73) [113].



Figure 73. Example of what an MFD can show [113]

3.3.2.3.2 Touchscreen Controllers (GTC)

The two GTCs serve as primary flight management systems and handle nearly all major pilot inputs (See Figure 74).

A grid of infrared rays is used by the GTC to detect where the contact occurred. This streamlines the tedious task of inputting data and navigating options. The drawback is that anything on the touchscreen may obstruct infrared rays and result in unintentional button activation.

An aural click sound is issued to confirm the button has been touched and the button background is highlighted in blue until the finger is released [113].



Figure 74. GTCs example of menu & frequency screens [113]

The menu structure is comforting and intuitive. When a window contains more information than it currently shows, a scroll bar and scroll buttons appear to easily get to the rest of it.

As shown in Figure 74, the controllers also have joysticks and knobs. They can be used for radio tuning and selection, frequency transfer, data entry, change selected COM radio sources... The joystick is used to increase or decrease map range, or to increase or decrease detail on certain system displays.

The left display pane placement on the MFD and the outboard display pane location on the pilot's PFD is typically controlled by GTC 1. The right display pane region of the MFD and the outboard display pane placement of the copilot's PFD are both controlled by GTC 2. However, as the eVTOL will not have a second PFD, it will only control the right display pane of the MFD [113].

3.3.2.3.3 Integrated Avionics Unit (IAU)

G3000 has dual IAUs. Each one contains a WAAS GPS receiver, which provides information to the pilot's PFD.

To make sure that the PFD is receiving reliable data from both GPS receivers, internal system testing is carried out.

There are occasions when even though both GPS receivers may be accurate, one GPS receiver may offer a more effective GPS solution. In this case, The better-performing GPS receiver will instantly connect to the PFD. [113].

3.3.2.3.4 Autopilot or Flight Control System GFC 700

The flight control system G3000 explained in section [2.3.1.4](#) is an integral part of flying an airplane. The system has a dedicated control panel that is located above the MFD and is easily accessible to the pilot (See Figure 75) [113].



Figure 75. GFC 700 over the MFD in G3000 Integrated Flight Deck [177]

3.3.2.3.5 System Alerts

When everything is running smoothly, gauge points and text on the display are green.

Gauge pointers and the display change color to express caution (amber) or alert (red) when risky operating circumstances occur [113].

3.3.2.3.5 Connections & Speed

The avionics system has many connections. Each connection is done with a different type of cable depending on the requirements of the connection. Some connections need to be almost instant, others need to be more safely, others do not depend on time, only on arrival...

To start, all antennas and sensors will be connected to the avionics system via the ARINC 664 protocol. The velocity of transmission of this protocol is from 10 to 100 Mbps.

When talking about the Integrated Flight Deck, the system has many subsystems and each system has a different connection depending on its requirements. All the connections are defined in [APPENDIX B](#).

If the connection is done with an HSDB, a fiber optic serial data bus operating at 80 Mbps will be installed.

If the connection is done with an ARINC-429 data bus, the data rate will be from 12.5 kbps to 100 kbps.

If the connection is done with a CAN bus, the data rate will be from 125 kbps to 1 Mbps in multiples of 125.

If the connection is done with RS-232, the data rate will have a maximum of 1 Mbps.

If the connection is done with RS-422, the data rate will be up to 10 Mbps.

Finally, if the connection is done with RS-485, the data rate will be up to 10 Mbps.

To see it more clearly, Table 6 resumes the different types of bus connections with their data rate:

CONNECTION	DATA RATE
ARINC-664	10 – 100 Mbps
ARINC-429	12.5 – 100 kbps
HSDB	Up to 80 Mbps
CAN	125 kbps – 1 Mbps
RS-232	Up to 1 Mbps
RS-422	Up to 10 Mbps
RS-485	Up to 10 Mbps

Table 6. Types of connection buses and their data rates

3.3.3 Sidestick

3.3.3.1 Description

A sidestick, side-stick controller, or yoke is an aircraft control column that is located on the side console of the pilot, usually on the left-hand side. Typically found in aircraft equipped with fly-by-wire control systems.

This device is used for piloting most fixed-wing aircraft. The pilot uses the yoke to control the plane in both pitch and roll. They can control the ailerons and the roll axis by turning the control wheel. The up and down movement of the yoke controls the elevators and the pitch of the aircraft.

Before computerization and in many small planes still built today, the yoke was mechanically connected directly to the control surfaces by a series of cables and rods, meaning that muscle power was needed to fly the aircraft. This yoke was big (both hands were needed) and located in the center, in front of the pilot and copilot. Nowadays, thanks to fly-by-wire control systems, these tasks can be easily done with a sidestick and just one hand.

The sidestick is used in many modern military fighter aircraft and civil aircraft. Airbus includes the side stick in all aircraft since its first implementation in 1985.

Additionally, it is utilized in modern helicopter models like the Bell 525 [116].

3.3.3.2 Advantages VS Disadvantages

The new computer-based controls freed up the necessity of using two hands on the control column and simplified controls.

The designers and engineers found that replacing the control column with a sidestick offers the following advantages [117]:

- More space in the cockpit (leg room) to pull out a tray to view documents, do paperwork, eat, etc.
- Unobstructed view of the center instrument/control panel
- Better for handling strong G-forces and producing quick control inputs
- Suited for high-gain activities like aerial refueling, monitoring guns, or landing aircraft carriers
- The arm can be resting on some surface, just move the wrist

However, not everything can be good. The sidestick control also has some drawbacks [117]:

- No feeling about what is happening to the aircraft

- When stalling, the side stick vibrates a lot
- Side sticks are very sensitive

3.3.3.3 Model – Airbus Sidestick

The model that will be installed in the aircraft is the sidestick from Airbus (See Figure 76) or a similar one. The providers have been contacted but no answer has been received. Only replicas for simulators are found. However, the explanation is done believing this sidestick will be used.

This model gives an easy intuitive and great way to fly, leaving room between the pilot's legs for more important objects, such as a table.



Figure 76. Airbus sidestick [188]

When the pilot pulls it, the nose of the airplane moves up, if the pilot pushes it forward, the nose drops. Turning it to the left means banking to the left, same to the right. An interesting thing is that the pilot does not need to trim the aircraft, it is done automatically.

However, the sidestick does not do just what the pilot may ask for. Several independent computers interpret what the pilot's input is on the sidestick and deflect control surfaces.

The autopilot is the basis of the control chain, and its signals are interpreted by flight computers before further orders are sent to the control surfaces (See Figure 77 to understand how the system works). The computers do not let the pilot bust the safety limits.

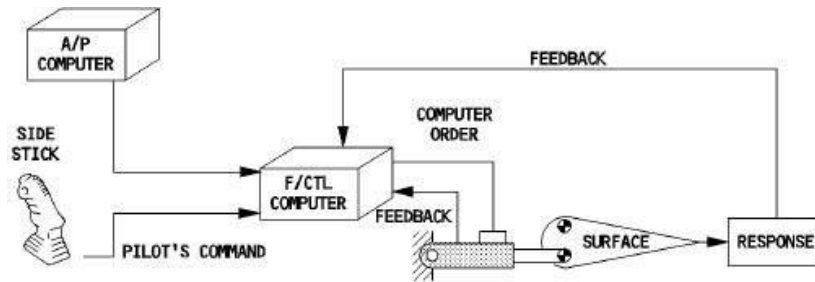

Figure 77. Sidestick and autopilot working principle [188]

This working principle is perfect for example when the pilot needs to get away from the ground fast. The pilot can just go full-back stick without worrying about a stall because the computer will understand the order.

In case the pilot loses control of the control surfaces, there is a red button that is called the instinctive takeover pushbutton, which will take over the control surfaces to recover the aircraft.

It can work also as an autopilot disconnect button [188].

3.3.3.4 Future Side Stick

To have even more space in the cabin and be simpler, in the future, the sidestick will be a sphere instead of a column.

This way the arm of the pilot can rest and with the fingers, the pilot could turn up and down the aircraft, bank left or right...

Nowadays this type of joystick does not exist, but during the development of the project, a sphere joystick will be developed to try it if the technology permits so.

3.4. CABIN COCKPIT DESIGN

The cockpit is designed to be very simple and spacious. The distribution of the screens, buttons, and joystick will be all concentrated on the left side of the cabin as the jet will be flown only by one pilot, and, in the future, without any pilot (See Figure 78).

Nevertheless, there will be still two seats, one for a passenger on the right side, and the other one for the pilot on the left side until the aircraft is fully autonomous. Then, it will be for another passenger as well.



Figure 78. Cabin cockpit design from the center behind the seats

The passenger on the right side will not have any screen nor button or knob in front dedicated to the avionics. It will have a screen to check the flight status, watch videos, films... All the space will be dedicated to the comfort of the passenger. There will be a foldable table to eat, work with a computer, read, or just rest the arms.

The passenger will enjoy the incredible views through the windows just in front and right side (See Figure 79).



Figure 79. Cabin cockpit design from the left-side

The pilot will have two big screens just in front. The one on the left will be the PFD and the one on the right will be the MFD. The PFD will be situated just in front of the pilot's seat, while the MFD will be in the middle of the cockpit, next to the PFD.

On top of the screens, the autopilot menu controller will stand with all the buttons and knobs. It will be accessible for the pilot by just stretching the arm.

Down the MFD, the two GTCs appear. They are placed vertically, one next to the other one.

Taking advantage of the two GTCs, an armrest is placed, where the thrust lever is found. Some other buttons and knobs are placed to turn on/off lights, cabin systems, air conditioning...

On the left hand of the pilot, another armrest is found with the sidestick.

On top of the screens (PFD & MFD) and the left-hand armrest, wide windows are placed so that the pilot can see through (See Figure 80).



Figure 80. Cabin cockpit design from the right-side

CHAPTER 4. FUTURE TECHNOLOGY IMPLEMENTATION

4.1. INTRODUCTION

Nowadays, everyday technologies such as mobile touchscreens or voice assistants that have been with us for many years, are still a bit taboo in airplanes.

However, more and more aircraft are implementing the use of glass cockpits with touchscreens in their cockpits. The ONA Jet will have Garmin's G3000 Integrated Flight Deck with four touchscreen displays.

Moreover, as voice-controlled technology is continually advancing and just as Apple's Siri, Google Assistant, or Amazon's Alexa are part of consumers' daily lives, engineers and researchers are working on new cockpit systems that will allow pilots to control airplanes with voice commands.

Voice-controlled technology seeks to reduce pilot workload by increasing automation in the cockpit. The objective is that the voice assistant takes care of the most tedious tasks of the pilot (tuning to a radio frequency, turning toward a heading, or checking the weather). This way the pilot can spend less time on tedious and time-consuming tasks.

To understand the difficulty of this to be a reality, some ideas must be taken into account.

First of all, the language of the pilot is very different from the colloquial. There is a whole jargon that the AI of the voice assistant has to understand and interpret. The end goal is to incorporate that understanding of the natural language processing context, and then process it, and then bring that value to the cockpit.

Secondly, it is essential to isolate the background noise of the aircraft (engines, usual noise inside the cabin, air hitting the nose...).

Finally, and one of the most important features, is that in any airplane, orders must be instantaneous. Engineers have stated that the response time should not be longer than 250 milliseconds to ensure the system can move faster than the pilot.

Urban air mobility and general aviation aircraft will likely be the first to see voice-controlled technology.

Companies agree that SPIFR aircraft are ideal candidates as those virtual assistants can help reduce workload. eVTOLs will also be well-suited for increased automation since so many pilots will be needed to operate them [118, 119, 120].

Once virtual assistants are a reality in commercial aircraft, the next step will be to have aircraft flown by AI machines and not by pilots. This is the final objective of ONAerospace's first jet.

4.2. VOICE ASSISTANT. DESIGN OF A VIRTUAL INTELLIGENT VOICE ASSISTANT

4.2.1 Introduction

One of the main characteristics of the ONA Jet is that it will have sooner or later a voice assistant to be capable to fly with one pilot reducing its workload. In the future, the idea is that it should be capable to fly without any pilot thanks to this voice assistant control and the avionics system implemented.

In this section, a description of how to achieve this voice assistant is done, together with the feasibility nowadays.

4.2.2 System Functionality

At the very beginning of the discussion of Voice-Controlled Aircraft (VCA), some basic questions appear: which functions can be controlled by voice commands? Can the pilot control the flight just by voice commands? Which is the level of control that can be achieved?

During a typical flight, the pilot controls a lot of functions of the onboard systems. Each function has a different priority level and a different influence on aircraft safety. Having said that, three different function levels can be defined taking into account serviced functions and speech recognition procedures [118]:

- **Level I:** Just auxiliary operations that do not directly affect flying (deicing, taxi light, etc.). The voice recognition process may be a word-detecting tool, and it is acceptable for the tool to make occasional mistakes.
- **Level II:** There are more flight-state-influencing operations available (gear up/down, flaps down/approach/up, etc.). The direction, altitude, and airspeed crucial navigation operations cannot be operated without particular safety devices in place, however an autopilot can be engaged and deactivated.

The system must be equipped with functions protecting against abnormal values of stabilized flight parameters and too dynamic maneuvers. The speech recognition procedure can also be a word spotting application but the requirements for speech recognition accuracy are higher than Level I. However, some mistakes in the system are still allowed.

- **Level III:** Functions for spacecraft altitude stabilization are provided (pitch & roll stabilization functions). Any emergency procedures for

rescuing the aircraft from perilous and irregular flight conditions should also be used. At this level, voice recognition accuracy must be almost 100% and processing times must be very fast. A short vocabulary coupled with a word recognition system should be used for the voice recognition process.

As always, redundancy is necessary to ensure flight safety. Functions initialized by the Speech Recognition Module (SRM) will be doubled by standard control devices. All commands recognized by the SRM can be acknowledged by voice.

Levels II and III include functions strictly related to airplane flight control. This implies they have a direct influence on flight safety. Pilots should be trained on how to use the speech recognition functionality and deal with possible mistakes, especially when talking about Levels II and III [118].

4.2.3 Commands

4.2.3.1 Commands Requirements

The voice command recognition system (Voice Assistant) is thought to be implemented into an avionics system to increase the pilot's comfort and decrease the pilot's workload. The commands that the pilot uses to control both onboard systems and the flight of the aircraft must have a pilot-friendly form.

To be identified as pilot-friendly ones, voice commands must meet some requirements:

- Commands must take the form of common aviation expressions.
- Commands must be as short as possible (easier to remember and less time to say them).
- Both numeric (high accuracy required: "Heading 2 degrees left") and linguistic (not high accuracy required: "Heading more right") values are accepted.
- Linguistic values can have different meanings depending on the circumstances of a flight
- Phonetically different phrases can mean the same if necessary. For example, "some" and "more" should bring the same result.
- Commands must be unique, and different from each other enough to protect against the situation when they could be confused.

4.2.3.2 Commands Classification

The voice recognition system should operate with both onboard systems and flight control ones. Taking this into account, available commands can be put into four basic sets of instructions as follows:

- Switch on/off type – “gear down”/”gear up”
- Defining the value of the controlled parameter directly – “roll ten right”
- Defining the value of the controlled parameter incrementally – “roll ten more right”
- Special emergency commands – “recover”

Another classification takes into account the way parameters of commands are defined in. Parameters can be defined in two ways:

- With the strictly defined numerical value of the parameter – “ten degrees”, “one hundred fifty knots”
- With linguistic variable describing the value of the parameter – “more”, “less”, “little”, “bigger”

4.2.3.3 Commands interpretation process

The commands interpretation process runs in a few steps, which can be seen in Figure 81:

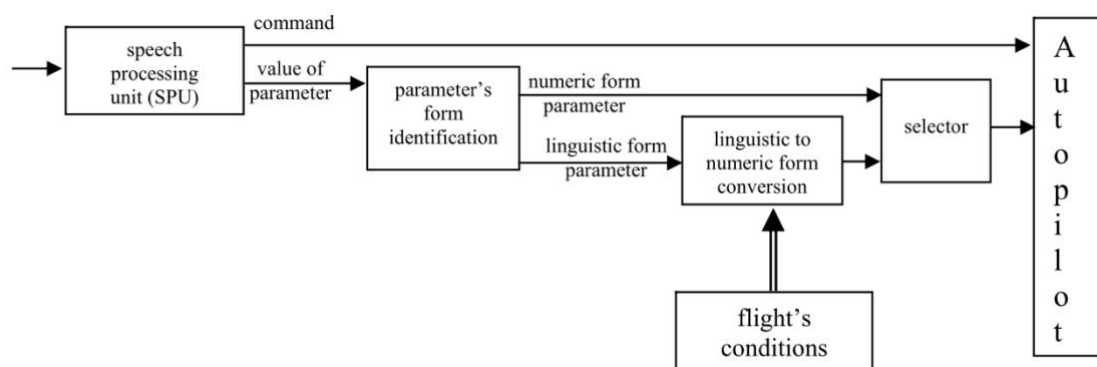

Figure 81. The commands interpretation process [118]

The Speech Processing Unit (SPU) recognizes the command and parameter's value. Its value is identified as a numerical or linguistic one.

The linguistic value is converted to a numerical value depending on the flight's conditions. If that process is completed, the command and its parameters are transformed into the form the control system accepts them and transmitted to it [118].

4.2.4 Flight Control

It is important to attempt to define the way the aircraft can be controlled in. The following features of hand control decide that it is rather difficult to imagine the situation when the pilot will directly steer control surfaces using voice commands.

- Pilots move control surfaces continuously, by hand. It would be difficult to realize such kind of command processing if pilots gave voice commands. The control surfaces can go to new positions only at discrete time moments, even if the pilot gives commands in one stream of words (See Figure 82).

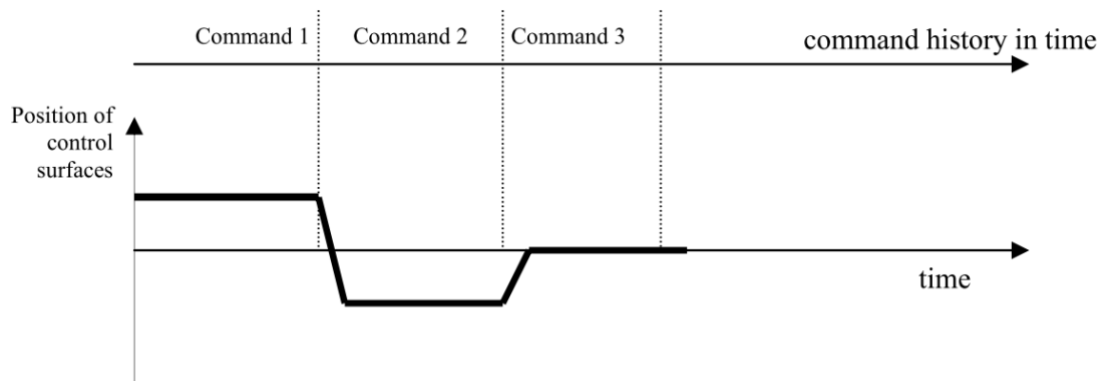

Figure 82. Series of three commands, only executed at discrete time moments [118]

Moreover, it is impossible to correct any pilot's mistake immediately, some period is lost. Prior to saying and activating the new order, the plane will be flown wrongly.

- Commands must be formulated according to the requirements before defined
- Pilots cannot calculate the new position of control surfaces just after something happens (e.g. wind turbulence)
- It is important whether the movement is dynamical or sluggish
- The pilot often deflects more than one set of control surfaces simultaneously (e.g. ailerons and ruder). With commands by voice, it will be difficult to generate movements of more than one set of control surfaces at the same moment.

Facts put at the foregoing points probably decide that it is possible to control the plane indirectly only. It means the control of the aircraft with the use of any system autonomously stabilizing selected flight parameters. It is necessary to integrate the SRM with the autopilot (See Figure 83).

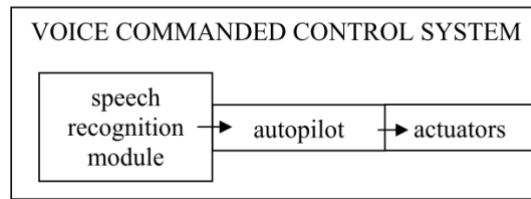

Figure 83. SRM integrated with autopilot's system [118]

This way, the autopilot will realize some of the basic functions of the aircraft flight parameter control activated by SRM. Sample functions could be attitude controlling, altitude, heading, and speed stabilization, among others [118].

4.2.5 Possibility of realization

4.2.5.1 Time of System Reaction (TSR)

The voice commands can be used to control aircraft if speech recognition procedures enable fast and reliable command recognition only. The system must correctly recognize commands in a time period shorter than the pilot can indicate any delay.

Taking into consideration the human perception possibilities, it can be said that the Time of System Reaction (TSR) can be defined by the following formula:

$$T_{SR} = \frac{1}{2}T_{HR}$$

Where T_{SR} is the time the system needs to recognize the command and take proper action, and T_{HR} is the time a human pilot needs to indicate and recognize any event.

Assuming that the average reaction time for humans is about 0.2 – 0.25 s, the system should take action in less than 0.1 s [118].

4.2.5.2 Development of Technology

The hardware platform for this purpose as well as the voice recognition algorithms have been separately developed for years. They have reached a level that enables using speech recognition procedures in different areas currently (mobile phones with voice dialing, instruments used in medicine...).

Unfortunately, all of those systems require rather strictly defined commands, which can be used, but they cannot recognize commands from a continuous speech in general [118].

4.2.5.3 Limitations

Commonly used systems do not recognize all commands correctly due to several conditions: voice intonation, accents, speed of speaking, voice volume, and speaking correctness... The level of recognition reaches about 90% of defined commands currently.

The fact is that whether the system misses or misunderstands commands, it cannot be used to control any aircraft's system critical function, especially functions controlling the flight. Supplementary or basic navigation functions which do not have any influence on the plane's safety directly can be served only.

Taking into consideration the limitation of capacities of the speech recognition systems, **it can be stated that it is impossible to create a full voice-commanded avionic system yet** [118].

Nevertheless, some attempts to approach the perfect solution can be undertaken. Below, some considerations concerning the speech recognition module are given:

4.2.5.3.1 Noise

It should be noted that speech recognition in the plane cockpit is accomplished in a noisy environment with possible interferences from another person (e.g. the copilot, or cabin crew).

The speech recognition accuracy is positively correlated with the Signal-to-Noise Ratio (SNR) of the speech signal. Therefore, every noise and sound source different from the recognized one cause strong degradation of speech recognition accuracy.

These problems are partially minimized in modern cockpits by some special close-talking microphones in the headsets that reduce noise levels and are insensitive to sounds from far-field. However, these technical means may not be sufficient when the speech recognition procedures will have to be applied.

Therefore, additional noise-reducing procedures such as a wiener filter or means eliminating interfering sounds such as a microphone array are needed.

Besides these methods, softening the pilot's cabin with sound-absorbing materials may also bring good results [118].

4.2.5.3.2 Vocabulary

The quantity of the vocabulary and problematic terms in the lexicon need to be taken into account while developing voice control for a plane.

Speaking of vocabulary growth, speech recognition becomes slower and less precise as it grows larger. As a result, it is best if there are the fewest potential words and utterances that are recognized.

By turning off the recognition of instructions that are not being used at the time, this issue can be partially solved.

Installing a highly fast computer and using discriminant analysis or Principal Component Analysis (PCA) methodologies in the recognition process will result in a voice recognition module that is entirely pilot-friendly [118].

4.2.5.3.3 Speaker Dependency

Discussing speaker reliance raises other issues. Many voice recognition technologies today operate without regard for the speaker.

Speaker-dependent procedures often provide greater speech recognition accuracy than speaker-independent ones.

Because the pilot may log in to the board system and record all voice instructions using his or her voice before initially running the speech recognition module, it is rather simple to create a speaker-dependent speech recognition method for VCA [118].

4.2.5.3.4 Time Response

A very important issue to consider is real-time speech recognition. It means that applied speech recognition procedures must be fast enough to ensure command recognition with a maximal 0.1 s delay.

The short time of recognition has usually a negative influence on recognition accuracy, therefore, a fast computer and properly chosen algorithms are very important to minimize this problem [118].

4.2.6 Aviation Voice Assistants Nowadays

It is well-known that nowadays it is impossible to have a fully voice-commanded avionic system for aircraft. However, many companies are developing and implementing some source of voice assistants for airplanes. In this section, the main companies and their achievement and future goals are explained.

4.2.1.1 Thales Group

The research and development engineering division of Thales is working on a version of their touchscreen FlytX avionics suite with an AI virtual pilot assistant for future jet cockpits.

Smart displays will be used only in the cockpit, with no incorporated avionics bay-style computers. To maximize SWAP and have fewer LRUs, it will combine the autopilot, the FMS, a synthetic vision, a virtual assistant, and other optional components.

The pilots will receive voice and flying intention recognition from the virtual assistant. The assistant will understand instructions from ATC (directions, frequencies, etc.) and suggest any required flight control adjustments on the display.

But the human pilot will always have the final say. The command on the screen will be accepted or rejected by the pilot.

For example, during a simulated demonstration flight between Le Bourget and Amsterdam, when arriving at Amsterdam Flight Information Region (FIR), the virtual assistant proposed the new necessary frequency by which pilots would be able to communicate through voice with ATCs in Amsterdam. By dragging that frequency into the active frequency channel, that becomes the new active frequency the pilot is using.

Thales believes that this system will be ready to enter service by 2025. However, they say there are some regulatory hurdles to clear and more development to go through [121].

4.2.1.2 Honeywell Aerospace

At Honeywell Aerospace, engineers and scientists are developing new cockpit technology that will let pilots operate their aircraft using voice commands.

They want to reduce pilot workload by increasing automation in the cockpit. Pilots will give simple commands (tuning to a radio frequency, turning to a heading, weather...) which will be processed by the system's neural network and the information will be displayed automatically to the pilot or action to the control surfaces will start.

As consumers grow accustomed to touchscreens and other technologies, now are becoming accustomed to voice control and Honeywell is working to give pilots the same tech in the cockpit as they have in their daily lives.

Before voice-controlled aircraft can fly, Honeywell must teach the system to understand aviation jargon, of which there is no shortage.

Volunteers with a wide range of dialects, accents, and speech patterns record hundreds of possible commands in a sound booth. Simulated airplane noises are played in the background as they record to mimic the sounds of a real cockpit.

Moreover, the response from the system and aircraft needs to be instantaneous. Engineers from Honeywell have refined the response time to 250 milliseconds to ensure the system can move faster than the pilot.

During a recent visit, people from the website Insider demoed a basic version of the technology and they say it was surprisingly intuitive and quick to respond to.

During all the tests, researchers are gathering data on how it impacts fatigue levels and whether it helps to ease pilot workload [124].

4.2.1.3 Rockwell Collins

A research team from the Rockwell Collins Advanced Technology Center asked themselves whether a pilot could command a plane same way people can tell Siri to draft a text message or dial a phone number.

A decade later, around 2016, Rockwell Collins flight-tested speech recognition to verify that it works with cockpit avionics.

Next, the system must show that the software recognizes the myriad tones, cadences, and accents from human speech, and do that more accurately than Siri or similar software in a noisy cockpit and emergencies. They are still working on it.

At Rockwell Collins, they estimate that voice recognition can shave up to 75 percent off the time required to complete such cockpit tasks as changing altitude, speed, heading, and tuning a radio or displaying charts.

They describe the process as essentially working like this: the pilot says the command, which is picked up by a microphone. Then, algorithms in the avionics computers compare the words against a pre-programmed list of commands and choose the command that best matches the pilot's words. Those are then converted into a machine language that the avionics can recognize. In turn, the command is sent to a central routing application that routes it to the correct avionic subsystem.

Some of the benefits a voice-controlled cockpit gives are better situational awareness and reducing the pilot's workload.

However, there are some hurdles, like noise or difficult and reliable software coding [122].

4.2.1.4 Voice Flight Systems

Voice Flight's VFS101 is the world's first speech recognition system to be certified by the FAA for use in civilian aircraft. It meets all the rigorous safety requirements of FAA certification.

Voice Flight uses a revolutionary speech recognition system with patented algorithms combined with a very limited and specific vocabulary of commands to enable extremely fast and accurate recognition of a wide variety of speech, including various accents.

VFS101 uses the aviation industry's standard ICAO phonetic alphabet (Alpha, Bravo, Charlie, etc.) to allow the pilot to spell out waypoints and airways and enter them into the aircraft's GPS navigation systems many times faster than using GPS control knobs or touchscreen.

Manual control of the GPS units is always available should any difficulties be encountered with the VFS101 [123].

However, this system can only be used as a navigation assistant because it is not programmed to understand other commands such as change of heading, weather...

4.2.7 Ongoing & Future Scenario

At present, voice recognition prototypes are being tested and are expected to be soon available for use in military and commercial aircraft. Although few aircraft are already using similar technology in limited form.

However, the global market of in-flight voice recognition systems has been affected due to the COVID-19 situation.

The ongoing research and development (R&D) in the in-flight voice recognition systems were hampered during the lockdowns and government restrictions. The supply of inflight voice recognition system parts and tests on prototypes were on hold for many months due to flying restrictions.

Now that life is going back to normality and the COVID-19 situation is being forgotten, the technological advancements to improve flight safety and increasing government investments are some of the factors that drive the inflight voice recognition market growth.

Counterparts are the high costs of integrating voice recognition systems in aircraft and ambient noise [125].

Hopefully in a few years aircraft will be equipped with inflight voice recognition systems and the ONA Jet will be one of those.

4.3. UAV SYSTEM

4.3.1 Introduction

UAVs and Unmanned Aircraft Systems (UAS), known as “drones”, have the potential to become some of the most influential and iconic technologies of the 21st century.

Combining the capabilities of autonomous flight and advanced methods of data collection, UAVs are believed to provide an unprecedented tool for achieving more cost-effective, time-efficient, and safer processes.

These capabilities are now increasingly incorporated into civilian domains into applications such as surveillance or sensing missions, logistics, and passenger transportation.

Unmanned aircraft are already often used in search and rescue, infrastructure maintenance, and agriculture. In contrast, their use as a form of transportation is still in its early stages.

Another type of unmanned vehicle is passenger drones, often referred to as “air taxis”. These cutting-edge aircraft are typically eVTOLs with a capacity to carry 1-6 passengers and a range of about 25-250 km.

eVTOL flights within and around metropolitan areas are no longer the stuff of science fiction. Urban Air Mobility (UAM) is an industry term for on-demand, highly automated (unpiloted), passenger, or cargo-carrying air transportation services.

It is an innovative transportation option to avoid congestion plaguing many cities and suburbs around the world.

However, traffic in the skies will become increasingly dense. City and regional authorities will need to create a low-level sky law, with airways, vertical airport points, rules...

The progress of unmanned aircraft technologies could have unprecedented economic and social benefits, but also unknown environmental and social consequences.

Consequently, the pace of UAV technology development demands immediate critical analysis and proactive assessment. The beginning of a new era in which low-level airspace may become the “third dimension” of transportation is starting and will become a reality soon [126, 127].

ONAAerospace will work until the technology is enough to create a UAV.

4.3.2 Projects in Development

Today, there are many companies, universities, and government organizations developing many unmanned aircraft designs.

Some of the most important are:

4.3.2.1 Lilium Jet

The prototype of the Lilium Jet changed a lot during its development. Wings that could fold forward were considered in the first design studies so that the aircraft could be flown as a VTOL. A first half-scale demonstrator flew in 2015.

Two years later, in 2017, Lilium changed the configuration into a two-seater without a pilot and performed the first flight of the unmanned prototype.

As this prototype worked, the company decided to try a five-seat unmanned aircraft. In 2019, the Lilium Jet was flight tested. However, after 100 flights, it did not work properly how the company desired. Moreover, the first prototype was destroyed by fire during maintenance.

A second, unfinished prototype was abandoned, and the company began to work on the actual Lilium Jet (See Figure 84), which is a seven-seat aircraft with one pilot and six passengers [128].

Even though the final prototype has a pilot, the company will try to eliminate it and, in the end, have an unmanned aircraft.

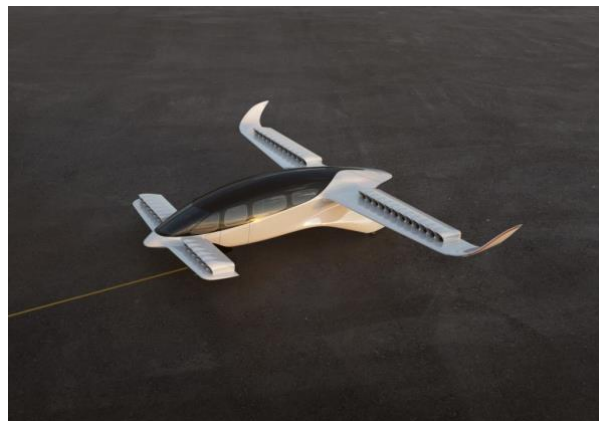

Figure 84. Final Prototype Lilium Jet [129]

4.3.2.2 Volocopter Volocity

The company, based in Germany, stated the Volocopter was being designed to be flown with the option of being piloted by a pilot, remotely, or autonomously. The Volocopter is supposed to be simple, safe, and green.

The original plan was to have one-seat, two-seat, and four-seat eVTOL aircraft passenger models.

The one-seat passenger model was never made. The same happened with the four-seat one, called e-Volo VC400. The VC400 concept design was never made for becoming a subscale or a full-scale prototype.

The concept of the Volocopter company became reality with the two-seat passenger model, also known as VoloCity (See Figure 85).



Figure 85. VoloCity Aircraft Model [131]

It is entirely powered by electricity and may be piloted or operated independently. Currently, it can fly for 30 minutes with a maximum range of 17 miles. The aircraft is very quiet for the passengers and people on the ground.

The VoloCity was first flown unmanned in 2013 but indoors. In 2015, remote-controlled outdoor testing started. After more than 100 flights, Volocopter received the permit to fly in Germany.

Despite the VC400 never being created, the company is now working on the development of a new four-seat passenger aircraft design, called VoloConnect (See Figure 86) [130, 131].



Figure 86. VoloConnect Aircraft Model [131]

4.3.2.3 eHang 184

eHang is an Autonomous Aerial Vehicle (AAV) technology platform company based in China that was the pioneer of all-electric aerial transportation through multiple proprietary products and services.

The eHang AAV's technical design idea is based on three tenets: autonomous pilot, centralized control of the intelligent command-and-control center, and complete redundancy to assure security.

The first idea of the company, in 2012, was the eHang 184 AAV (See Figure 87), which had manned and unmanned flight testing but never arrived at the market.



Figure 87. eHang 184 AAV [132]

In 2018, the company unveiled that it had a new version, called eHang 216 (See Figure 88). This version has two seats and twice as many arms as the eHang 184.



Figure 88. eHang 216 AAV [133]

This drone was built with full redundancy in its systems, has 100% green technology, and is powered by electricity only.

The technology of autonomous flying does away with the danger of malfunction or failure brought on by human mistakes. Flight routes will be surveyed in advance to present multiple feasible plans for the user.

eHang AAV uses 4G or 5G as the high-speed wireless transmission channel to communicate smoothly with the command-and-control center, thus enabling remote control of the aircraft and real-time transmission of flight data.

Passengers do not have to worry about flying or managing the plane; they can just relax and enjoy the trip. [134, 135].

4.3.2.4 CityAirbus NextGen

The CityAirbus NextGen follows other Airbus UAM initiatives: the Airbus Vahana, a single-seat eVTOL demonstrator, and the CityAirbus demonstrator, a four-seat eVTOL demonstrator.

Airbus Vahana (See Figure 89) is an all-electric, single-seat, tilt-wing vehicle demonstrator that focused on advancing self-piloted, eVTOL flight. It cannot fly autonomously, it is self-piloted with smart sensors [136].



Figure 89. Airbus Vahana Demonstrator [136]

CityAirbus demonstrator (See Figure 90) is an all-electric, four-seat, multi-copter vehicle that focused on advancing remotely piloted eVTOL flight [137].



Figure 90. CityAirbus Demonstrator [137]

After more than 242 flights with the Vahana and CityAirbus demonstrators, Airbus updated the CityAirbus project to the CityAirbus NextGen (See Figure 91), which is an all-electric four-seater drone that can be flown autonomously. As a concept, it is promising, futuristic, and truly magnificent.



Figure 91. CityAirbus NextGen [138]

The new configuration boasts a fixed wing, a V-shaped tail for stability, and eight electric propellers without moving surfaces or tilting parts. It should carry up to four passengers over 80 km at 120 km/hour.

The configuration of the CityAirbus NextGen is imagined for exploring autonomous flight in full compliance with the highest safety levels. However, at the launch, it would be pilot operated, moving to full autonomous mode once the technology catches up [138, 139].

CHAPTER 5. CONCLUSIONS

The aviation sector has a great impact on the climate through the release of nitrogen oxides, water vapor, and sulfate plus soot particles at high altitudes. This impact was reduced due to the COVID-19 crisis. However, the aviation industry is now more contaminant than before due to the increasing use of jets and the number of commercial flights.

The present climate emergency has brought to light the importance of a zero-emission future. Companies around the world have been developing electric aircraft for many years but it is nowadays that is gaining significance in the global market.

ONAEROSPACE has been created to develop a new airplane concept, an eVTOL jet aircraft that will be used in the future as an aero taxi for big cities or as an intercity connection aircraft. The aircraft is supposed to be fully autonomous with a voice assistant to inform the passengers about the flight conditions.

Nevertheless, the cabin of the aircraft is designed for one pilot. It has four touchscreen displays that show all the information in a friendly way. It is simple and very roomy, for the comfort of the pilot and passengers. The system is from Garmin and it is very ergonomic and easy-to-use.

The development of this aircraft needs a great number of sensors and antennas to collect as much information as possible from the surroundings. Antennas and sensors from classic airplanes to modern drones will be installed. As the project is still in development, many companies try to avoid telling the price of their systems until they are sure it is going to be paid.

The information from all sensors and antennas is transmitted to the main computer and systems through a very modern intern communication network, which combines the classic technologies (CAN bus or ARINC protocols) with the newest and fastest ones (5G technology and optical fiber). Then the information is displayed on the screens of the cabin.

All these antennas, sensors, and systems are very expensive as they are cutting-edge technologies.

To install a voice assistant system with artificial intelligence that will work properly, the headsets from the pilot, the cabin windows, and materials from the cabin are able to reduce ambient noise and listen to the voice of the pilot very accurately, as well as the ATC commands.

However, although the idea of being fully autonomous is nowadays impossible because the existing technology is still not capable, there are many projects working on it. There are already some voice assistants that help the pilot to reduce workload.

To conclude, the project can be feasible but the idea of having a fully autonomous aircraft with a voice assistant is still impossible. Right now, the aircraft can be developed to be for single-pilot instrumental flight rules with an artificial intelligence pilot monitoring voice assistant that will reduce the pilot's workload and with some actions that can be autonomous.

BIBLIOGRAPHY

- [1] *Fly electric: The aircraft of the future takes flight*. (n/d). Theatlantic.Com from <https://www.theatlantic.com/sponsored/thomson-reuters-why-2025-matters/electric-flight/208/>
- [2] *What is avionics?* (n/d). BAE Systems | the United States from <https://www.baesystems.com/en-us/definition/what-is-avionics>
- [3] Wikipedia contributors. (2022, February 25). *Avionics*. Wikipedia, The Free Encyclopedia. <https://en.wikipedia.org/w/index.php?title=Avionics&oldid=1073888157>
- [4] Poudel, N. (2019, July 14). *Avionics - List of all systems in avionics*. The Genius Blog. <https://www.geniuserc.com/aircraft-avionics/>
- [5] AviationHunt Team. (2021, July 8). *Aircraft communication system*. AviationHunt. <https://www.aviationhunt.com/aircraft-communication-system/>
- [6] Mike Tooley & David Wyatt, "Aircraft Navigation", Chapter 8 in *Aircraft Communications & Navigation Systems. Principles, Maintenance & Operation*, pp. 101-115, (2007)
- [7] *Flight Data Recorder (FDR)*. (2021, May 27). SKYbrary Aviation Safety. <https://skybrary.aero/articles/flight-data-recorder-fdr>
- [8] Wikipedia contributors. (2022, March 2). *Electronic flight instrument system*. Wikipedia, The Free Encyclopedia. https://en.wikipedia.org/w/index.php?title=Electronic_flight_instrument_system&oldid=1074807769
- [9] Wikipedia contributors. (2022, January 25). *Aircraft flight control system*. Wikipedia, The Free Encyclopedia. https://en.wikipedia.org/w/index.php?title=Aircraft_flight_control_system&oldid=1067758388
- [10] Loewy, R. G. (2003). Aircraft Avionics. In R. A. Meyers (Ed.), *Encyclopedia of Physical Science and Technology* (pp. 319–336). Elsevier.
- [11] Mike Tooley & David Wyatt, "Traffic Alert & Collision Avoidance System", Chapter 22 in *Aircraft Communications & Navigation Systems. Principles, Maintenance & Operation*, pp. 271-284, (2007)
- [12] Mike Tooley & David Wyatt, "Weather Radar", Chapter 20 in *Aircraft Communications & Navigation Systems. Principles, Maintenance & Operation*, pp. 239-249, (2007)

- [13] Mike Tooley & David Wyatt, "Flight Management Systems", Chapter 19 in *Aircraft Communications & Navigation Systems. Principles, Maintenance & Operation*, pp. 227-236, (2007)
- [14] Pallini, T. (2021, May 10). *Siri and Alexa are coming to airplane cockpits. Here's how engineers are working to take voice tech from sci-fi to reality.* Insider. <https://www.businessinsider.com/how-engineers-are-working-to-make-voice-controlled-aircraft-reality-2021-5?r=US&IR=T>
- [15] (S/f). Then24.com from <https://then24.com/2021/05/20/siri-and-alex-arrive-on-airplanes-pilots-can-now-fly-by-voice/>
- [16] *Fly by voice.* (2016, October 18). Aerospace America. <https://aerospaceamerica.aiaa.org/departments/fly-by-voice/>
- [17] (S/f-b). Europa.eu from <https://cordis.europa.eu/article/id/422305-speech-recognition-and-ai-help-take-the-pressure-off-aircrew>
- [18] *Antennas.* (n/d). Aopa.org from <http://aopa.org/training-and-safety/students/presolo/special/antennas>
- [19] Editorial Team. (2019, September 30). *The different types of aircraft antennas and their function.* Aero Corner. <https://aerocorner.com/blog/types-of-aircraft-antennas/>
- [20] Constantino Muñoz Porcar, 2021, October 20. *Antennas in aeronautical radio communications.* pp. 14. "Aeronautical Communications II"
- [21] *Radio communication – antenna types.* (n/d). Flight-Mechanic.Com. from <https://www.flight-mechanic.com/radio-communication-antenna-types/>
- [22] Houston, S. (n/d). *ADF/NDB Navigation System.* The Balance Careers from <https://www.thebalancecareers.com/the-adf-ndb-navigation-system-282773>
- [23] *Ground-Based Navigation – DME.* (n/d). FAA from https://www.faa.gov/about/office_org/headquarters_offices/ato/service_units/techops/navservices/qbng/lpdme
- [24] Wikipedia contributors. (2022, February 25). *Radar altimeter.* Wikipedia, The Free Encyclopedia. https://en.wikipedia.org/w/index.php?title=Radar_altimeter&oldid=1073989000
- [25] *Radio altimeter.* (2021, May 29). SKYbrary Aviation Safety. <https://skybrary.aero/articles/radio-altimeter>
- [26] *Radio navigation – radio altimeter.* (n/d). Flight-Mechanic.Com from <https://www.flight-mechanic.com/radio-navigation-radio-altimeter/>
- [27] *Emergency locator transmitter (ELT).* (2020, December 29). SKYbrary Aviation Safety. <https://skybrary.aero/articles/emergency-locator-transmitter-elt>

- [28] (n/d). Novotech.com from <https://novotech.com/learn/m2m-blog/blog/2021/11/15/ultimate-gps-antenna-knowledge-base/>
- [29] Editorial Team. (2019, September 30). *The different types of aircraft antennas and their function*. Aero Corner. <https://aerocorner.com/blog/types-of-aircraft-antennas/>
- [30] *Navigation Antenna, Beacons* (n/d). Experimentalaircraft.info from <https://www.experimentalaircraft.info/articles/aircraft-antenna-3.php>
- [31] Wikipedia contributors. (2022, March 2). *Automatic dependent surveillance-broadcast*. Wikipedia, The Free Encyclopedia. https://en.wikipedia.org/w/index.php?title=Automatic_Dependent_Surveillance%E2%80%93Broadcast&oldid=1074825554
- [32] Wikipedia contributors. (n/d). *Traffic collision avoidance system*. Wikipedia, The Free Encyclopedia. https://en.wikipedia.org/w/index.php?title=Traffic_collision_avoidance_system&oldid=1075106813
- [33] Hardiman, J. (2021, April 2). *What is TCAS and how does it work?* Simple Flying. <https://simpleflying.com/tcas/>
- [34] Wikipedia contributors. (2022, March 9). *Instrument landing system*. Wikipedia, The Free Encyclopedia. https://en.wikipedia.org/w/index.php?title=Instrument_landing_system&oldid=1076190983
- [35] *Radio navigation – instrument landing systems (ILS)*. (n/d). Flight-Mechanic.Com from <https://www.flight-mechanic.com/radio-navigation-instrument-landing-systems-ils/>
- [36] *ILS*. (n/d). AviationChief.Com. from <http://www.aviationchief.com/ils.html>
- [37] *Ultra-Small Marker Beacon Antenna with a Wide Frequency Tunable Capacitive Plate* (n/d). Wiley.com. from <https://onlinelibrary.wiley.com/doi/full/10.4218/etrij.16.0116.0158#:~:text=In%20an%20aeronautical%20radio%20navigation,essential%20for%20safe%20aircraft%20flight.>
- [38] Houston, S. (n/d). *VOR Navigation System*. The Balance Careers. from <https://www.thebalancecareers.com/vor-navigation-system-282557>
- [39] *Weather radar*. (2021, May 17). SKYbrary Aviation Safety. <https://skybrary.aero/articles/weather-radar>
- +
[40] *Communication Antenna* (n/d). Experimentalaircraft.info. from <https://www.experimentalaircraft.info/articles/aircraft-antenna-2.php#:~:text=An%20aircraft%20uses%20a%20range,for%20their%20own%20frequency%20band.>

[41] Aeronautics Guide (2017, May 15) *Aviation Radio Communication*. Blogger. <https://www.aircraftsystemstech.com/2017/05/aviation-radio-communication.html>

[42] *Product archive - Sensor Systems Inc., aircraft antenna*. (n/d). Sensor Systems Inc., Aircraft Antenna. From <https://www.sensorantennas.com/product/>

[43] *WXR-2100 MultiScan ThreatTrack™ weather radar*. (n/d). Rockwellcollins.com. from <https://www.rockwellcollins.com/~media/Files/Unsecure/Products/Product%20Brochures/Radar%20and%20Surveillance/Weather%20Radar/WXR-2100/WXR-2100%20MultiScan%20ThreatTrack.aspx>

[44] *Avionics & Accessories – VHF Communication Antennas* (n/d). Dallas Avionics from <https://www.dallasavionics.com/edo/edo.pdf>

[45] Rathore, A. (2018, September 17). *Sensors that add strength to aviation and aerospace*. Electronics For You. <https://www.electronicsforu.com/market-verticals/sensors-strength-aviation-aerospace>

[46] Polizzotto, J. (2017, October 17). *Importance of an aircraft sensor system in an airplane*. Bdaily. <https://bdaily.co.uk/articles/2017/10/17/importance-of-an-aircraft-sensor-system-in-airplane>

[47] *The sensors are found in planes*. (2019, March 25). AZoSensors.Com. <https://www.azosensors.com/article.aspx?ArticleID=1614>

[48] Bodell, L. (2020, December 4). *What are pitot tubes and how do they work?* Simple Flying. <https://simpleflying.com/pitot-tubes/>

[49] *The critical role of flow meters in the aviation industry* (n/d). Flowmetrics INC from <https://flowmetrics.com/role-flowmeters-aviation-industry/>

[50] dadams. (2016, November 18). *Aircraft and liquid level sensors*. SMD Fluid Controls. <https://www.fluidswitch.com/2016/11/18/liquid-level-sensors-function-aircraft/>

[51] *Product archive - Sensor Systems Inc., aircraft antenna*. (n/d). Sensor Systems Inc., Aircraft Antenna. from <https://www.sensorantennas.com/product/>

[52] *G015 gear flow meter*. (2018, May 3). Max Precision Flow Meters. <https://www.maxmachinery.com/product/g015-gear-flow-meter/>

[53] *Fluid Components International - AS-LLS aircraft liquid level sensor*. (n/d). Fluidcomponents.com. from <https://www.fluidcomponents.com/aerospace/aerospace-products/liquid-level-sensors/as-lls-aircraft-qualified-liquid-level-sensor>

- [54] *What you need to know about aircraft switches & sensors*. (2014, November 5). CCSDualSnap. <https://www.ccsdualsnap.com/pressure-switches-in-aerospace-applications/>
- [55] *Pressure Takes Flight*. (n/d). Bakerhughes.com. from <https://dam.bakerhughes.com/m/787a73b669ac58dd/original/Druck-Aerospace-Pressure-Takes-Flight-Brochure.pdf>
- [56] *Flight control position sensors*. (2018, June 5). LORD Corp. <https://www.lord.com/products-and-solutions/flight-control-equipment/flight-control-sensors/flight-control-position-sensors>
- [57] Administrator. (n/d). *Position sensors, speed sensors, and potentiometers*. Piher.Net. from https://www.piher.net/sensors/index.php?option=com_content&view=article&id=30&Itemid=34
- [58] *Custom Force Sensors for Aerospace* (n/d). Wwww.te.com. From <https://www.te.com/usa-en/industries/sensor-solutions/applications/force-sensors-for-aerospace-applications>
- [59] *Aircraft Instrument Systems* (n/d). Aircraftspruce.com. from https://www.aircraftspruce.com/catalog/pdf/ATS_Vol2.pdf
- [60] *What you need to know about aircraft sensors* (n/d). Globalspec.com. from <https://electronics360.globalspec.com/article/9934/what-you-need-to-know-about-aircraft-sensors>
- [61] *Introduction to altimeters*. (n/d). Uavnavigation.Com. from <https://www.uavnavigation.com/support/kb/general/general-system-info/introduction-altimeters>
- [62] Aeronautics Guide. (2017, June 4). *Aircraft Pressure Measuring Instruments*. Blogger. <https://www.aircraftsystemstech.com/2017/06/pressure-measuring-instruments.html>
- [63] Jean-Philippe Condomines, "Introduction to Aerial Robotics", Chapter 1 in *Nonlinear Kalman Filtering for Multi-Sensor Navigation of Unmanned Aerial Vehicles*, pp 1-21, (2018)
- [64] *Magnetometer, why is it critical for UAV navigation?* (n/d). Uavnavigation.Com. from <https://www.uavnavigation.com/company/blog/uav-navigation-depth-magnetometer>
- [65] *AHRS, Air Data Computers, and Magnetometers*. (n/d). Avionicswest.com. from <https://avionicswest.com/Articles/AHRS.html>
- [66] *Proximity Sensors*. (n/d). Cw-sensors.com. from <https://www.cw-sensors.com/Products/Proximity-Sensors>

- [67] *Honeywell launches proximity sensors for aircraft.* (n/d). Aviation International News. From <https://www.ainonline.com/aviation-news/business-aviation/2017-08-10/honeywell-launches-proximity-sensors-aircraft>
- [68] *Airborne Collision Avoidance System (ACAS).* (2021, mayo 25). SKYbrary Aviation Safety. <https://skybrary.aero/articles/airborne-collision-avoidance-system-acas>
- [69] *Ice detection and protection systems.* (n/d). Collinsaerospace.com. From <https://www.collinsaerospace.com/what-we-do/Military-And-Defense/Exteriors/Ice-Detection-Systems>
- [70] Nash, J. (n/d). *Sound idea: Acoustic technology lets small planes “listen” for nearby aircraft.* Scientific American. From <https://www.scientificamerican.com/article/acoustic-vector-sensing/>
- [71] *How angle of attack indicator works.* (n/d). SkyTough. From <https://www.skytough.com/post/how-angle-of-attack-indicator-works>
- [72] *Humidity Sensor suits aircraft environmental control systems.* (n/d). Thomasnet.Com. From <https://news.thomasnet.com/fullstory/humidity-sensor-suits-aircraft-environmental-control-systems-20025017>
- [73] *Solid state fatigue meter DESCRIPTION.* (n/d). Nasco.co.jp. From http://www.nasco.co.jp/cms/mark/pdf/AMETEK_Sensor/Solid_State_Fatigue_Meter.pdf
- [74] Embention. (2021, November 5). *Detect & Avoid - DAA: The power of combining multiple sensors.* <https://www.embention.com/news/detect-avoid/>
- [75] *Honeywell IntuVue RDR-84K Band Radar System.* (n/d). Honeywell.Com. <https://aerospace.honeywell.com/us/en/learn/products/weather-radar/intuvue-rdr-84k-band-radar-system>
- [76] *Technology in the airline industry.* (n/d). Odu.edu. <https://www.cs.odu.edu/~tkennedy/cs300/development/Public/M08-TechnologyintheAirlineIndustry/index.html>
- [77] *Aircraft flight management system (FMS).* (n/d). Aircraft Systems. From <https://www.aircraftsystemstech.com/p/flight-management-system-fms.html>
- [78] *Engine Indicating and Crew Alerting System (EICAS).* (2020, December 29). SKYbrary Aviation Safety. <https://skybrary.aero/articles/engine-indicating-and-crew-alerting-system-eicas>
- [79] *What you need to know about aircraft sensors* (n/d). Globalspec.com. From <https://electronics360.globalspec.com/article/9934/what-you-need-to-know-about-aircraft-sensors>

- [80] *Electronic Flight Instrument System*. (2021, May 27). SKYbrary Aviation Safety. <https://skybrary.aero/articles/electronic-flight-instrument-system>
- [81] *Automatic flight control system (AFCS)*. (n/d). Aircraft Systems. From <https://www.aircraftsystemstech.com/p/automatic-flight-control-system-afcs.html>
- [82] *Importance of Health Monitoring System for Aircraft* (n/d). Einfochips.com. From <https://www.einfochips.com/blog/importance-of-health-monitoring-system-for-aircraft/>
- [83] *Inertial reference systems are guiding airlines and the future of navigation*. (n/d). Honeywell.Com. From <https://aerospace.honeywell.com/us/en/learn/about-us/blogs/inertial-reference-systems-are-guiding-airlines-and-the-future-o>
- [84] Mohan, N. K. (n/d). *Fly-by-wire flight control system*. Aircraft Nerds. From <https://www.aircraftnerds.com/2019/12/fly-by-wire-flight-control-system.html>
- [85] *What is a Flight Control System?* (n/d). Wiki Motors. From <https://www.wikimotors.org/what-is-a-flight-control-system.htm>
- [86] *Aircraft health monitoring*. (n/d). Flyht.Com. From <https://flyht.com/actionable-intelligence/aircraft-health-monitoring/>
- [87] Rao, T. V. (2009, May 1). *CAN bus in aviation*. Aviation Today. <https://www.aviationtoday.com/2009/05/01/can-bus-in-aviation/>
- [88] Michal. (2020, July 27). *What is CAN bus protocol? - CAN bus theory*. 911 Electronic. <https://911electronic.com/what-is-can-bus-protocol/>
- [89] *[security research] CAN bus network integrity in avionics systems*. (n/d). Rapid7. From <https://www.rapid7.com/research/report/investigating-can-bus-network-integrity-in-avionics-systems/>
- [90] “Soft AFDX end system implementation with standard PC and Ethernet card”, EMRE ERDİNÇ (2010, May) from <https://etd.lib.metu.edu.tr/upload/12611929/index.pdf>
- [91] *AFDX@ARINC664P7 tutorial*. (2019, June 12). Aim Online. <https://www.aim-online.com/products-overview/tutorials/afdx-arinc664p7-tutorial/>
- [92] Eva, K. (n.d.). *Arinc 429, arinc629, arinc 664*. Studyflying.Com. from <https://studyflying.com/arinc-429-arinc629-arinc-664/>
- [93] Tang, X., Luo, Z., & Qu, G. (2020). Worst-case end-to-end delay analysis for an AFDX evolution network. *2020 IEEE 6th International Conference on Computer and Communications (ICCC)*, 78–82.

- [94] 13 the overview of avionics full duplex switched ethernet. (2016, November 15). [https://issuu.com/ijaersjournal/docs/13 the overview of avionics full-du](https://issuu.com/ijaersjournal/docs/13_the_overview_of_avionics_full-du)
- [95] Koon, J. (2020, January 24). *How fiber optics will propel future avionics*. Aviationtoday.Com. <https://interactive.aviationtoday.com/how-fiber-optics-will-propel-future-avionics/>
- [96] 5G: Taking the aviation industry to new heights - wipro. (2021, August). Wipro.Com. from <https://www.wipro.com/blogs/aayush-kulshrestha/5g-taking-the-aviation-industry-to-new-heights/>
- [97] 5G and aviation. (n/d). From <https://www.5gandaviation.com/>
- [98] Aviation and 5G. (n/d). Iata.Org. from <https://www.iata.org/en/programs/ops-infra/air-traffic-management/5g/>
- [99] Bilimoria, K. D., Johnson, W. W., & Schutte, P. C. (2014). A conceptual framework for single-pilot operations. *Proceedings of the International Conference on Human-Computer Interaction in Aerospace - HCI-Aero '14*.
- [100] EASA pro. (n/d). EASA. From <https://www.easa.europa.eu/home>
- [101] Part-CAT - commercial air transport operations - part-aero.com. (n/d). AeroZulu. From <https://part-aero.com/en/view/part-cat>
- [102] I Fly America, Inc. (n/d). *Single-Pilot IFR Made Easier*. Iflyamerica.org. From <https://iflyamerica.org/singlepilotifr.asp>
- [103] Mac McClellan, J. (2006, December 15). *Single pilot jets*. FLYING Magazine. <https://www.flyingmag.com/single-pilot-jets/>
- [104] *Single-Pilot IFR*. (n/d). AOPA Air Safety Foundation. From [https://www.aopa.org/-/media/Files/AOPA/Home/News/All-News/1997/Measure-of-Skill-\(9\)/sa05.pdf](https://www.aopa.org/-/media/Files/AOPA/Home/News/All-News/1997/Measure-of-Skill-(9)/sa05.pdf)
- [105] King, J., Cook, L., & Zimmerman, J. (2007, August 1). *The lazy pilot's guide to single-pilot IFR success*. Plane & Pilot Magazine. <https://www.planeandpilotmag.com/article/the-lazy-pilots-guide-to-single-pilot-ifr-success/>
- [106] Koebbe, B. (2019, June 6). *How to fly single-pilot IFR with a digital copilot*. FLYING Magazine. <https://www.flyingmag.com/single-pilot-ivr-digital-copilot/>
- [107] Collins, R. L. (2009, January 16). *How safe is single-pilot IFR?* FLYING Magazine. <https://www.flyingmag.com/pilot-technique-instrument-flight-rules-how-safe-single-pilot-ifr/>
- [108] *A20 Aviation Headset*. (2019, October 21). Bose.co.uk. https://www.bose.co.uk/en_gb/products/headphones/aviation_headsets/a20-aviation-headset.html

- [109] *The 7 best aviation handheld radios*. (2019, July 20). Aero Corner. <https://aerocorner.com/blog/best-aviation-handheld-radios/>
- [110] Tegler, E. (2019, November 13). *This system from Garmin can land a private plane when your pilot can't*. Ars Technica. <https://arstechnica.com/cars/2019/11/this-system-from-garmin-can-land-a-private-plane-when-your-pilot-cant/>
- [111] Sparks, K. (2019, October 15). *The 5 Best Single-Pilot Planes Equipped with Garmin Avionics*. Blog. <https://blog.wepushtin.com/blog/the-5-best-single-pilot-planes-equipped-with-garmin-avionics/>
- [112] *Glass cockpit*. (2021, May 27). SKYbrary Aviation Safety. <https://skybrary.aero/articles/glass-cockpit>
- [113] Garmin, & Garmin Ltd. or its subsidiaries. (n/d). *G3000*. Garmin. From <https://www.garmin.com/es-ES/p/66916>
- [114] Garmin, "G3000 Integrated Avionics System. Line Maintenance Manual", Section 2 – G3000 Description in *System/LRU description*, pp 2-1 – 2-4, (November 2014)
- [115] Cook, M. (2016, August 12). *Garmin G3000: Flight levels above G1000*. Aviation Consumer. <https://www.aviationconsumer.com/accessories/cockpitaccessories/garmin-g3000-flight-levels-above-g1000/>
- [116] Finlay, M. (2020, November 10). *Yokes vs side sticks - aircraft controls compared*. Simple Flying. <https://simpleflying.com/yokes-vs-side-sticks/>
- [117] *What are the pros and cons of a sidestick over yoke in modern planes?* (n/d). Quora. From <https://www.quora.com/What-are-the-pros-and-cons-of-a-sidestick-over-yoke-in-modern-planes>
- [118] Tomasz Rogalski & Robert Wielgat. *Aerospace Science and Technology. A concept of voice-guided general aviation aircraft*, pp 2-8 (2010).
- [119] Pallini, T. (2021, May 10). *Siri and Alexa are coming to airplane cockpits. Here's how engineers are working to take voice tech from sci-fi to reality*. *Business Insider*. <https://www.businessinsider.com/how-engineers-are-working-to-make-voice-controlled-aircraft-reality-2021-5>
- [120] *In-flight voice recognition market size, share, trends by 2027*. (n/d). Allied Market Research. From <https://www.alliedmarketresearch.com/in-flight-voice-recognition-market-A07151>
- [121] Bellamy, W., III. (2019, December 6). *FlytX, virtual AI assistant in development for future business jet cockpits*. Aviation Today. <https://www.aviationtoday.com/2019/12/06/flytx-virtual-ai-assistant-development-future-business-jet-cockpits/>

- [122] *Fly by voice*. (2016, October 18). Aerospace America. <https://aerospaceamerica.aiaa.org/departments/fly-by-voice/>
- [123] *Pilot speech recognition*. (n/d). Voiceflight.com. Retrieved August 13, 2022, from <https://www.voiceflight.com/>
- [124] Pallini, T. (2021, May 10). Siri and Alexa are coming to airplane cockpits. Here's how engineers are working to take voice tech from sci-fi to reality. *Business Insider*. <https://www.businessinsider.com/how-engineers-are-working-to-make-voice-controlled-aircraft-reality-2021-5>
- [125] *In-flight voice recognition market size, share, trends by 2027*. (n/d). Allied Market Research. From <https://www.alliedmarketresearch.com/in-flight-voice-recognition-market-A07151>
- [126] Kellermann, R. (2022, February 24). *Flying high? Unmanned aircraft and the future of transportation*. IPPI. <https://www.ippi.org.il/flying-high-unmanned-aircraft-and-the-future-of-transportation/>
- [127] *A civil future for unmanned aircraft systems*. (2016). <https://www.nasa.gov/aeroresearch/programs/iasp/uas/civil-future-for-uas>
- [128] Wikipedia contributors. (2022, July 13). *Lilium Jet*. Wikipedia, The Free Encyclopedia. https://en.wikipedia.org/w/index.php?title=Lilium_Jet&oldid=1097914101
- [129] *Lilium trae a España los ensayos de vuelo de su aeronave eVTOL*. (2022, April 6). Hispaviación. <https://www.hispaviacion.es/lilium-trae-a-espana-los-ensayos-de-vuelo-de-su-aeronave-evtol/>
- [130] *Volocopter e-volo VC400 (defunct)*. (n/d). Evtol.News. From <https://evtol.news/volocopter-e-volo-vc400-defunct>
- [131] *Volocopter brings urban air mobility to life*. (2021, February 16). Volocopter. <https://www.volocopter.com/>
- [132] Penalva, J. (2018, February 6). *Volar con un taxi-dron autónomo está más cerca: el vídeo que demuestra cómo lo hace el EHang 184*. Xataka.com; Xataka. <https://www.xataka.com/drones/volar-con-un-taxi-dron-autonomo-esta-mas-cerca-el-video-que-demuestra-como-lo-hace-el-ehang-184>
- [133] Vázquez, J. A. R. (2020, March 17). Ehang: Avión Eléctrico con Aprobación en Noruega y España. *Avatar Energía, blog de Energías Renovables*. <https://avatarenergia.com/ehang-avion-electrico/>
- [134] *EHang*. (n/d). Ehang.com. From <https://www.ehang.com/ehangaav/>
- [135] *EHang 184 (defunct)*. (n/d). Evtol.News. From <https://evtol.news/ehang/>

- [136] Pattanaik, D. (2020). *Vahana*. Rupa Publications. From <https://www.airbus.com/en/urbanairmobility/cityairbus-nextgen/vahana>
- [137] *CityAirbus demonstrator*. (2022, June 17). Airbus.com. <https://www.airbus.com/en/urbanairmobility/cityairbus-nextgen/cityairbus-demonstrator>
- [138] *CityAirbus NextGen*. (2021, June 24). Airbus.com. <https://www.airbus.com/en/innovation/zero-emission/urban-air-mobility/cityairbus-nextgen>
- [139] Wikipedia contributors. (2021, November 18). *Airbus CityAirbus*. Wikipedia, The Free Encyclopedia. https://en.wikipedia.org/w/index.php?title=Airbus_CityAirbus&oldid=1055896517
- [140] *Radio altimeter antenna - es*. *Onlinestorecheaps.Ru*. (n/d). Onlinestorecheaps.Ru. From <https://es.onlinestorecheaps.ru/category?name=radio%20altimeter%20antenna>
- [141] *Artex C406-2 ELT With Rod Antenna*. (n/d). Aircraft Spruce. From <https://www.aircraftspruce.ca/catalog/avpages/artexC406-2.php>
- [142] *Antennas for aircraft transponders*. (n/d). *Www.Airteam.Eu*. From <https://www.airteam.eu/antennas-6>
- [143] *Facebook*. (n/d). Facebook.com. From <https://www.facebook.com/Pilots-In-Uganda-2000877933569175/>
- [144] Technic, A. [air_technic]. (2016, January 27). *Here is a Marker Beacon antenna. Marker beacons are part of the ILS(Instrument Landing System) landing system.* *pic.twitter.com/pny9qq1gti*. Twitter. <https://twitter.com/>
- [145] *NAV antennas from comant*. (n/d). *Sarasotaavionics.com*. From <https://sarasotaavionics.com/category/antennas/nav-antennas-%28vor-gs%29>
- [146] Georgilidakis, S. (2021, April 16). *Black noses – why did airliners have them?* *Mentour Pilot*. <https://mentourpilot.com/black-noses-why-did-airliners-have-them/>
- [147] *Aviation weather radar part I: Attenuation*. (2019, June 13). *Computer Training Systems*. <https://www.ctsys.com/aviation-weather-radar-part-i-attenuation/>
- [148] *Rockwell Collins WXR 2100*. (2015, November 24). *Drabpol; Drabpol Sp. Jawna P. Drabczyński i Wspólnik*. <https://drabpol.pl/pl/awionika-kompetencje/capability-list/radary-pogodowe/rockwell-collins-wxr-2100/>
- [149] *COM/VHF*. (n.d.). Aircraft Spruce. From https://www.aircraftspruce.com/menus/av/antenna_com.html

[150] Aircraft Sensor Applications (n/d). Www.te.com. From <https://www.te.com/usa-en/industries/sensor-solutions/applications/solutions-for-aircraft-applications.html>

[151] *Aircraft temperature sensor* (n/d). Lemaprod.com. From <https://shop53002.lemaprod.com/category?name=aircraft%20temperature%20sensor>

[152] Electronic Products. (2016, June 29). *The critical role of sensors in drone innovation*. Electronic Products. <https://www.electronicproducts.com/the-critical-role-of-sensors-in-drone-innovation/>

[153] The UAV platform, equipped with different sensors and systems (n/d). Researchgate.net. From https://www.researchgate.net/publication/282878129_Real-time_single-frequency_GPSMEMS-IMU_attitude_determination_of_lightweight_UAVs/figures?lo=1

[154] Brasil. (n/d). *Pitot is a very important tool for the pilots because it measures the*. iStock. From <https://www.istockphoto.com/es/foto/y-los-aviones-de-pitot-gm176067413-10468056>

[155] Air Data Systems (n/d). *The forefront of air data technology*. Collinsaerospace.com. From <https://www.collinsaerospace.com/what-we-do/industries/commercial-aviation/flight-deck/surveillance/air-data-systems>

[156] *P213 piston flow meter*. (2022, June 17). Max Precision Flow Meters. <https://www.maxmachinery.com/product/p213-piston-flow-meter/>

[157] *AS-PT*. (n/d). Fluidcomponents.com. From <https://www.fluidcomponents.com/aerospace/aerospace-products/pressure-sensors/as-pt>

[158] *Dual-tandem aerospace LVDTs*. (n/d). Honeywell.com. From <https://sps.honeywell.com/us/en/products/advanced-sensing-technologies/aero-and-transportation-sensing/aero-and-transportation-sensors/motion-and-position-sensors/aerospace-position-measurement/dual-tandem-aerospace-lvdt>

[159] *Rotary variable differential transformer*. (n/d). Honeywell.com. From <https://aerospace.honeywell.com/us/en/products-and-services/product/hardware-and-systems/sensors/rotary-variable-differential-transformer>

[160] *Hawk™ 3-inch series resolvers*. (n/d). Honeywell.com. From <https://sps.honeywell.com/us/en/products/advanced-sensing-technologies/aero-and-transportation-sensing/aero-and-transportation-sensors/motion-and-position-sensors/resolvers/3-inch-series>

- [161] *Temperature sensors.* (n/d). Honeywell.com. From <https://sps.honeywell.com/us/en/products/advanced-sensing-technologies/industrial-sensing/industrial-sensors/temperature-sensors>
- [162] *High-performance sensors for the aerospace industry.* (n/d). Scaime.com. From <https://scaime.com/aerospace>
- [163] *260A13 - Sensor de fuerza para avión by PCB PIEZOTRONICS SA.* (n/d). Aeroexpo.online. From <https://www.aeroexpo.online/es/prod/pcb-piezotronics-sa/product-170285-37739.html>
- [164] *208C03 - Sensor de fuerza de torsión by PCB PIEZOTRONICS SA.* (n/d). Aeroexpo.online. From <https://www.aeroexpo.online/es/prod/pcb-piezotronics-sa/product-170285-37770.html>
- [165] *Embedded force sensor for aircraft, helicopter, drone, rocket.* (n/d). Sensy.com. From <https://www.sensy.com/en/blog/embedded-force-sensor-for-aircraft-helicopter-drone-rocket--b46>
- [166] *Honeywell Precision Barometer and altimeter (HPB/HPA).* (n/d). Honeywell.com. From <https://aerospace.honeywell.com/us/en/products-and-services/product/hardware-and-systems/sensors/honeywell-precision-barometer-and-altimeter>
- [167] *DRA-2421 - wavenet radio & avionics.* (n/d). Wavenet Radio & Avionics. From <https://www.wavenetradio.com/en/projects/dra-2421/>
- [168] *AR3000 distance measurement sensor.* (2020, May 27). Acuity Laser. <https://www.acuitylaser.com/product/laser-sensors/long-range-sensors/ar3000-distance-measurement-sensor/>
- [169] Southeast Aerospace Inc. (n/d). *Garmin GMU-44.* Seaerospace.com. From <https://www.seaerospace.com/sales/product/Garmin/GMU-44>
- [170] Southeast Aerospace Inc. (n/d). *Garmin GRS-77.* Seaerospace.com. From <https://www.seaerospace.com/sales/product/Garmin/GRS-77>
- [171] *AMETEK introduces first digital humidity sensor for aircraft environmental control systems.* (n/d). News Powered by Cision. From <https://news.cision.com/ametek/r/ametek-introduces-first-digital-humidity-sensor-for-aircraft-environmental-control-systems,c9563624>
- [172] *Accelerometers.* (n/d). Ameteksfms.com. From <https://www.ameteksfms.com/products/accelerometers>
- [173] *GAPS series proximity sensors.* (n/d). Honeywell.com. From <https://sps.honeywell.com/us/en/products/advanced-sensing-technologies/aero-and-transportation-sensing/aero-and-transportation-sensors/motion-and-position-sensors/proximity-sensors/general-aerospace-proximity-sensor-gaps-series>

- [174] *Serie de sensores de proximidad para aplicaciones severas (HAPS)*. (n/d). Honeywell.com. From <https://sps.honeywell.com/mx/es/products/advanced-sensing-technologies/aero-and-transportation-sensing/aero-and-transportation-sensors/motion-and-position-sensors/proximity-sensors/harsh-application-proximity-sensor-haps-series>
- [175] *Casia detect-and-avoid*. (2021, July 26). Iris Automation. <https://www.irisonboard.com/casia/>
- [176] Luminar's Hydra LiDAR Sensor (n/d). Ppmgmbh.com. From <https://ppmgmbh.com/gps-produkte/luminar-hydra-lidar-sensor/>
- [177] Wikipedia contributors. (2022, August 10). *Garmin G3000*. Wikipedia, The Free Encyclopedia. https://en.wikipedia.org/w/index.php?title=Garmin_G3000&oldid=1103661071
- [178] GDC 74 Air Data Computer Installation Manual (n/d). Garmin.com. From http://static.garmin.com/pumac/GDC74A_74B_InstallationManual.pdf
- [179] Garmin, & Garmin Ltd. or its subsidiaries. (n/d). *GFC 700*. Garmin. From <https://www.garmin.com/es-MX/p/70143>
- [180] *Auriculares para pilotos A20*. (n/d). Bose.es. From https://www.bose.es/es_es/products/headphones/aviation_headsets/a20-aviation-headset.html
- [181] *Garmin Pilot App for Airspace* (n/d). Gxtstore.com. From https://www.gxtstore.com/?product_id=307266405_35
- [182] *ForeFlight - integrated flight app for pilots*. (n/d). Foreflight.com. From <https://foreflight.com/>
- [183] *Citation CJ3+ by CESSNA AIRCRAFT COMPANY*. (n/d). Aeroexpo.online. From <https://www.aeroexpo.online/es/prod/cessna-aircraft-company/product-174531-1846.html>
- [184] *The reimagined Phenom 300E*. (2020, January 5). Aopa.org. <https://www.aopa.org/news-and-media/all-news/2020/may/pilot/the-reimagined-phenom-300e>
- [185] Zhang, B. (2019, March 1). We flew on Honda's new \$5.25 million private jet. Here are its coolest features. *Business Insider*. <https://www.businessinsider.com/honda-jet-elite-coolest-features-photos-2019-3>
- [186] *N527EX*. (n/d). JetPhotos. From <https://www.jetphotos.com/photo/9341615>

- [187] *Daher QUEST KODIAK 100 sold by.* (n/d). Guardian Jet. From <https://www.guardianjet.com/aircraft-for-sale-listings/aircraft-sold.cfm?aid=Daher-QUEST%20KODIAK%20100-264-413>
- [188] Abadeer, N. (2017, August 5). *Control sidestick in Airbus - How it works? - AN Aviation.* AN Aviation Services Co; AN Aviation Services Co. <https://an.aero/how-does-the-control-sidestick-in-airbus-aircraft-work/>
- [189] *GPWS.* (n/d). Skybrary.Aero. From <https://skybrary.aero/gpws>
- [190] Wikipedia contributors. (2022, August 23). *Ground proximity warning system.* Wikipedia, The Free Encyclopedia. https://en.wikipedia.org/w/index.php?title=Ground_proximity_warning_system&oldid=1106110876

APPENDICES

Appendix A. Sensors Weight & Cost Estimation Table

Sensor	Model	Quantity	Price (€/unit)	Weight (kg)	Provider
Pitot Tube	Model 0856	2	Request	1.9	Collins Aerospace
Flow Meter	P213 Piston	1	760	1	Max Machinery
Liquid Level	AS-LLS	~20	3,020	0.23	FCI® Aerospace
Pressure	AS-PT	~30	1,810	0.23	FCI® Aerospace
Position (LVDTs)	1LVTT070ADB	~10	3,470	0.95	Honeywell
Position (RVDTs)	HMC1501	~30	1,185	Negligible	Honeywell
Position (Resolvers)	3-Inch Series	~10	Request	0.9	Honeywell
Temperature (Thermostats)	3500 Series	~5	765	0.0075	Honeywell
Temperature (Probes)	500 Series	~5	50	0.0013	Honeywell
Temperature (RTD)	700 Series	~5	30	Negligible	Honeywell
Force	260A13	~50	5,150	0.3	PCB Piezotronics
Torsion	208C03	~100	775	0.023	PCB Piezotronics
Sensitivity	Embedded Force	~30	Request	0.208	Sensy
Barometric Altimeter	HPA	1	From 845	0.142	Honeywell
Radio Altimeter	DRA-2421	1	2,350	0.35	Wavenet
Laser Altimeter	AR3000	1	Request	0.85	Acuity Laser
Magnetometer	GMU-44	1	2,172	0.23	Garmin
AHRS	GRS-77	1	4,506	1.59	Garmin
Angle of Attack	0863D1	~5	Request	1.2	Collins Aerospace
Humidity	8TJ315AAA1	~10	Request	0.2	AMETEK
Fatigue Meter	3001-01-111-2	1	Request	0.68	AMETEK

Proximity	GAPS Series	~10	3,083	0.085	Honeywell
Proximity	HAPS Series	~10	Request	0.15	Honeywell
Optical Cameras	CASIA X	1	Request	2.4	Iris Automation
LIDAR	Iris LIDAR	5	950	0.9	Luminar
RADAR	RDR-84 K Band	3	Request	0.7	Honeywell
De-Icing	0871 Series	~5	Request	0.32	Collins Aerospace
TOTAL		~300	~539,558*	~83.176	

Table 7. Summary of all sensors, prices, and weights

*Price without the "Request" ones

Appendix B. G3000 Systems

LRU	LRU Description	LRU Notes
GDU	Display Unit	<p>Each unit is configured as one of two PFDs or an MFD. The unit installed on the left (pilot) side is designated as PFD1, and the one installed on the right (copilot) side is designated as PFD2. The unit installed in the center is designated as the MFD.</p> <p>These units communicate with each other, with the GTC units, and with the on-side GIA through a High-Speed Data Bus (HSDB) connection.</p>
GTC	Touch Screen Controller	<p>Two units are installed. The unit installed on the left (pilot) side is designated as GTC1, and the one installed on the right (copilot) side is designated as GTC2.</p> <p>These units communicate with the GDUs via HSDB connection.</p>
GIA	Integrated Avionics Unit	<p>Each GIA contains a GPS/WAAS receiver, VHF COM/NAV/GS receivers, an FD, aircraft I/O interfaces, and system integration microprocessors.</p> <p>Each GIA is paired with the on-side PFD via HSDB connection. The GIA units communicate directly with each other via the CAN protocol only when a system data path failure has occurred.</p>
GDC	Air Data Computer	<p>Processes data from the pitot/static system. This unit provides pressure altitude, airspeed, vertical speed, and Operational Air Traffic (OAT) information to the system, and it communicates with the GIAs and GSUs via ARINC 429.</p>

LRU	LRU Description	LRU Notes
GEA	Engine & Airframe Interface Unit	Receives and processes signals from the engine and airframe sensors. This unit communicates both GIAs using an RS-485 digital interface.
GRS	AHRS	Provides aircraft attitude and heading information via ARINC 429 to the GDUs and GIAs. The GRS contains advanced sensors (including accelerometers and rate sensors) and interfaces with the on-side GMU to obtain magnetic field information, with the GDC to obtain air data, and with both GIAs to obtain GPS information.
GMU	Magnetometer	Measures local magnetic field. Data is sent to the GRS for processing to determine aircraft magnetic heading. This unit receives power directly from the GRS and communicates with the GRS using an RS-485 digital interface.
GMA	Audio Processor & Marker Beacon Receiver	Integrates NAV/COM digital audio, intercom system, and marker beacon functions. Each GMA communicates with its on-side GTS via HSDB and cross-side GIA via RS-232 as a backup control path.
GTX	Transponder	Solid-state transponders that provide Modes A, C and S capability. The GTX supports diversity antennas, European enhanced surveillance, and ADS-B 1090 MHz extended squitter transmit capabilities. Each transponder communicates via RS-422 digital interface and has an optional RS-232 backup connection for increased availability.
GDL 69A	XM Weather & Radio Datalink	A satellite radio receiver that provides (throughout North America) real-time weather information to the MFD and PFD Inset Map. As well as digital audio entertainment. The GDI 69A communicates via HSDB connection. A subscription to the XM Satellite Radio service is required to enable the GDI 69A's XM capabilities.

LRU	LRU Description	LRU Notes
GRC	XM Controller	Remote controller that allows passengers to adjust the volume and channel of the GDL 69A XM radio. The GRC communicates wirelessly with the GRT.
GRT	XM Controller Transceiver	Transceiver that communicates with the GTC wirelessly and the GDL 69A via RS-232.
GDL 59	Wi-Fi Datalink & Flight Parameter Recorder	Provides system Wi-Fi connectivity. The GDL 59 communicates via HSDB connection. The GDL 59 may optionally communicate with one or two GSR 56 units via RS-232. Computers or EFBs may also be connected through three Ethernet ports.
GSR	Iridium Satellite Transceiver	Provides voice and data communication via the Iridium satellite network. The GSR communicates via RS-232.
GMC	AFCS Mode Controller	Provides the controls for the AFCS through an RS-232 digital interface allowing communication with both PFDs.
GWX	Airborne Weather Radar	Provides airborne weather and ground mapped radar data via HSDB connection.
GSD	Data Concentrator	This unit is a data concentrator used to expand the input and output capabilities of the system. Communication is through HSDB.
GSA	Servo Actuator	The GSA units are used for the automatic control of pitch, roll, and yaw. These units interface with both GIA via RS-485.
GSM	Servo Gearbox	The GSM units transfer the output torque of the GSA servo actuator to the mechanical flight-control surface linkage.

LRU	LRU Description	LRU Notes
GTA	Trim Adaptor	The GSA units are used for the automatic trim for pitch, roll, and/or yaw. These units interface with both GIA via RS-485.
GA 36	GPS/WAAS Antenna	Through-mount GOS/WAAS Antenna.
GA 37	GPS/WAAS & XM Antenna	Through-mount GOS/WAAS Antenna with XM/Data Link.
GDR	Digital Radio	Digital Radio with VHF Data Link (VDL) Mode 2 capabilities.
GTS 820	TAS Traffic System	Traffic advisory system. The GTS communicates via HSDB.
GTS 850	TCAS I Traffic System	TCAS I traffic detection system. The GTS communicates via HSDB.
GTS Processor	TAS, TCAS I, TCAS II	The GTS Processor is an aircraft-installed surveillance product that includes both active surveillance (TAS, TCAS I, or TCAS II configurable) and passive surveillance (ADS-B).
GPA	Power Amplifier	Power amplifier used with the GTS 820 and GTS 850 units.
GA 58	Traffic Antenna	Directional antenna for use GTS 820 and GTS 850.
GCU	PFD Control Unit	Controls PFD operation.

Table 8. G3000 LRUs description

Appendix C. System Block Diagram

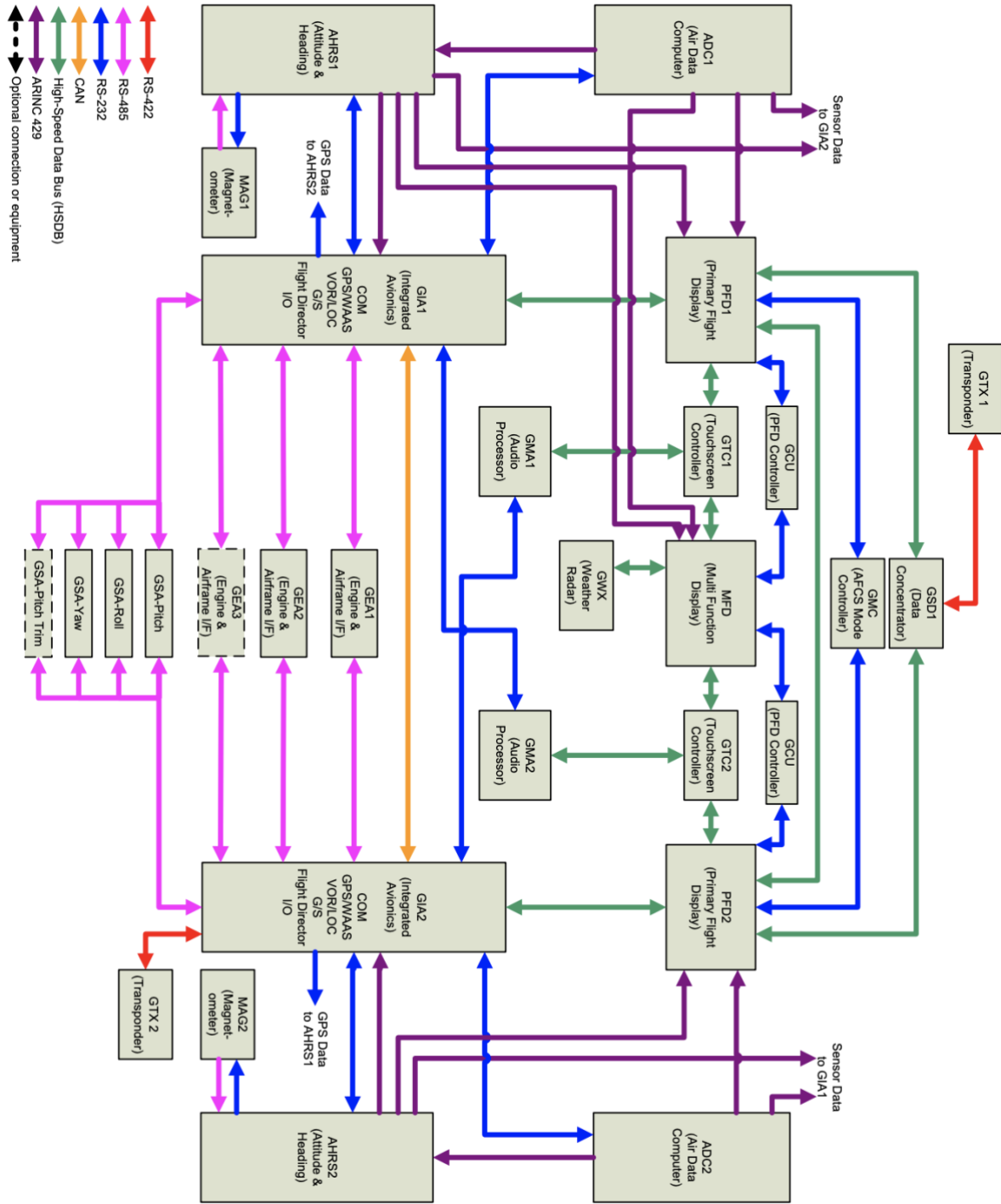

Figure 92. System Block Diagram G3000 Integrated Flight Deck [114]