

CONSTRUYENDO EL EQUILIBRIO

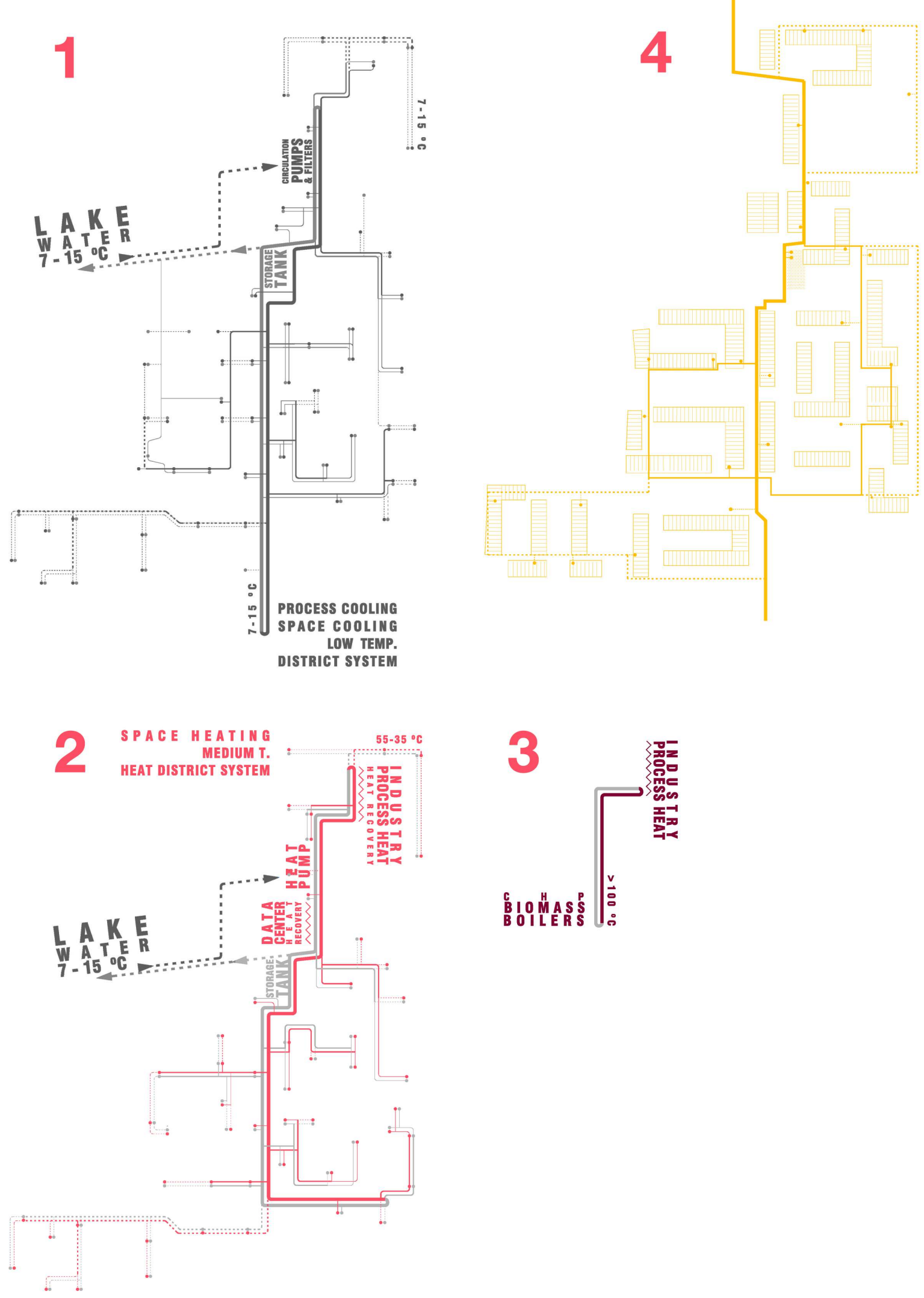

M: Sistema energético

M: Sistema urbano

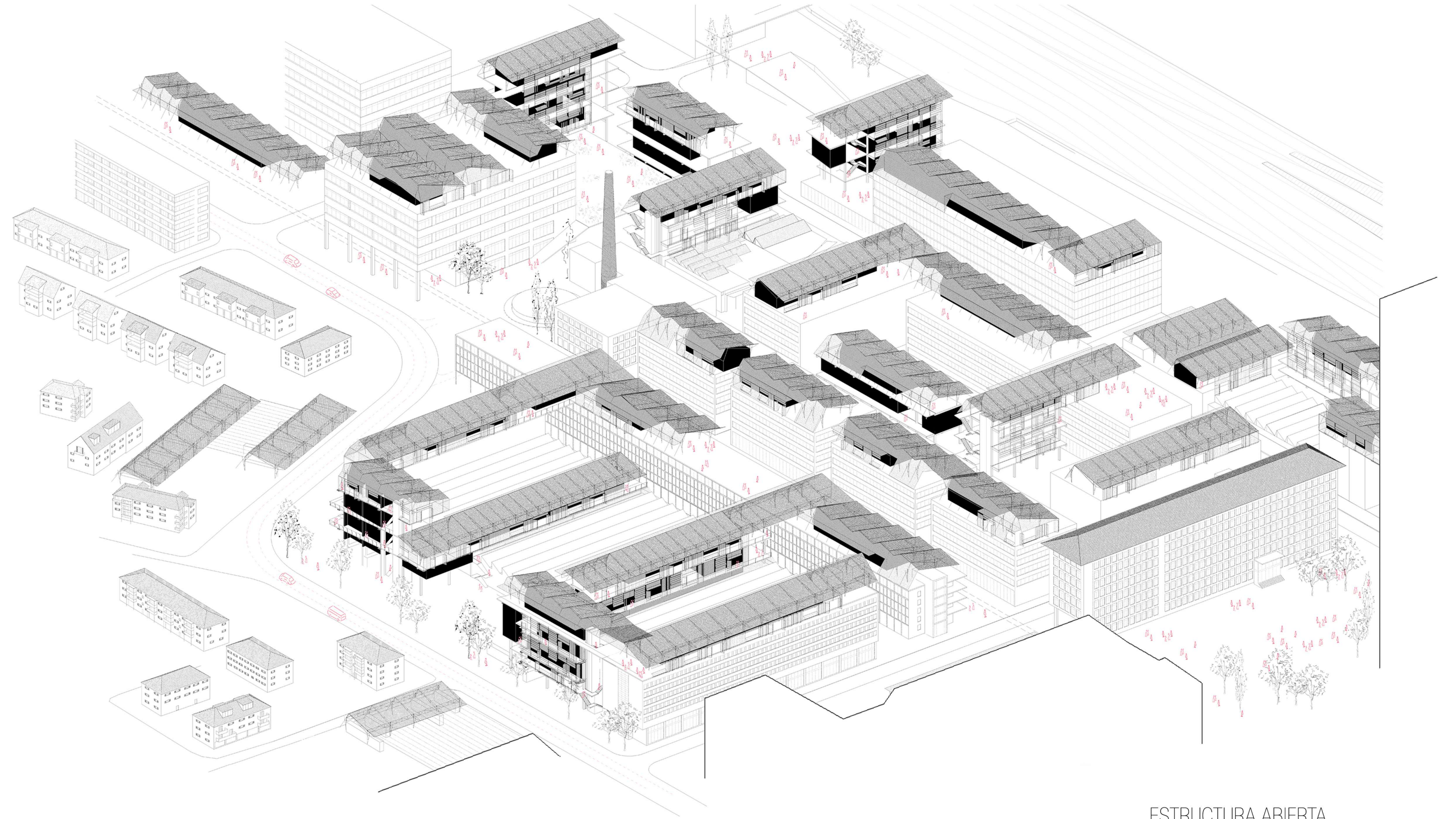

M: SOPORTE URBANO I

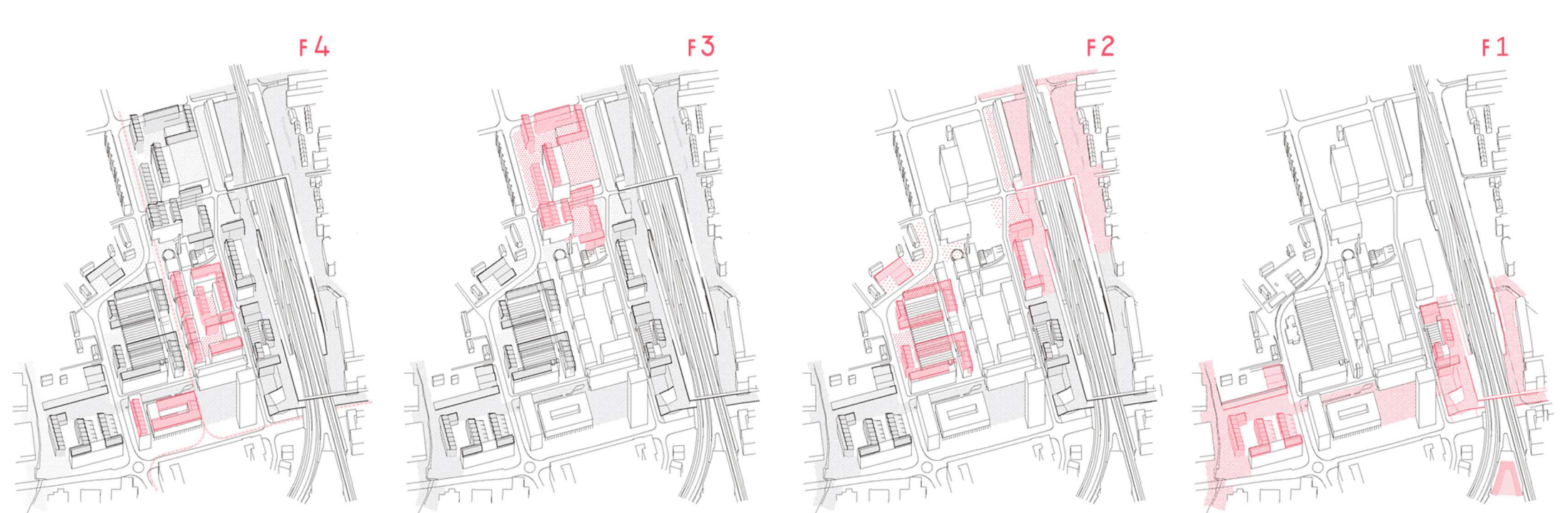
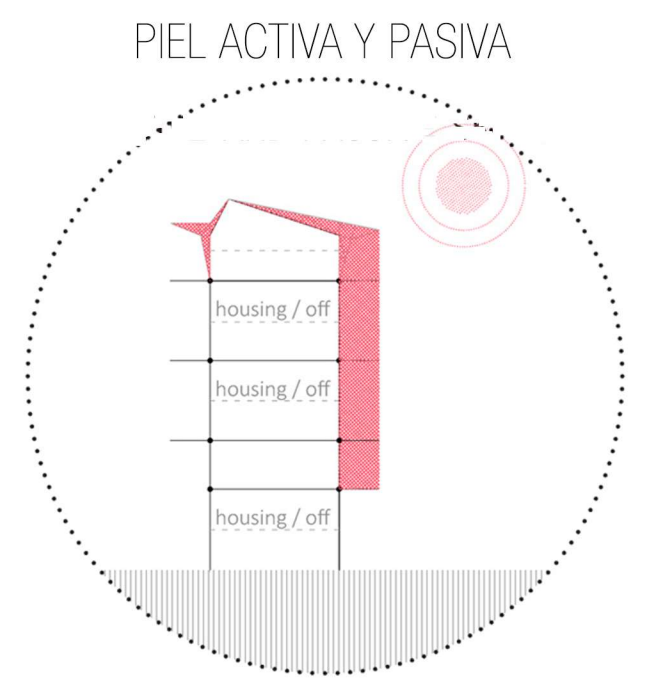
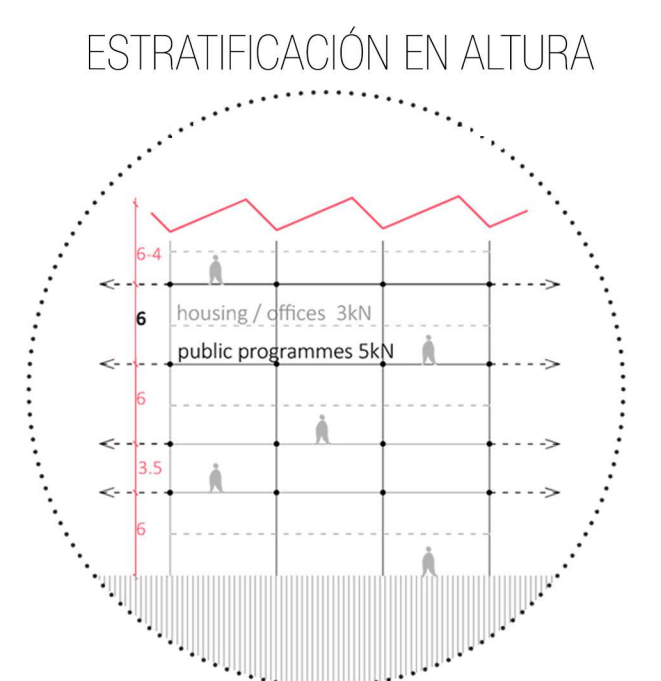
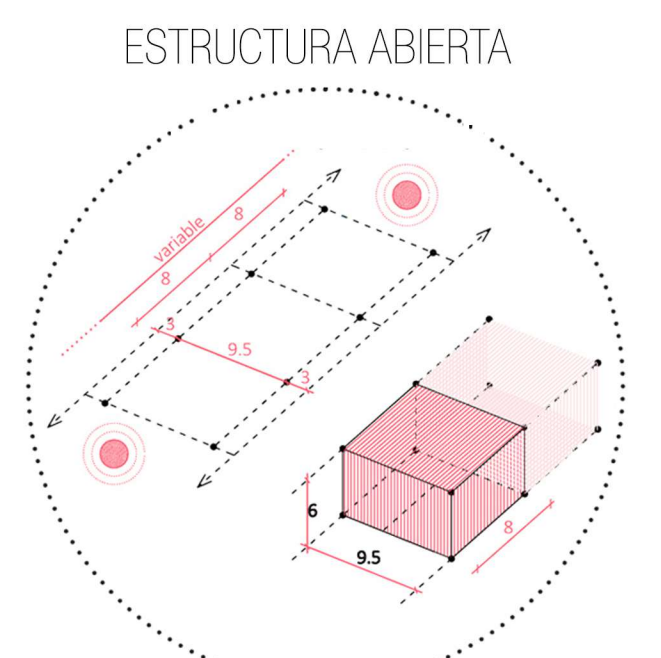

FASES URBANAS: 2015 - 2050

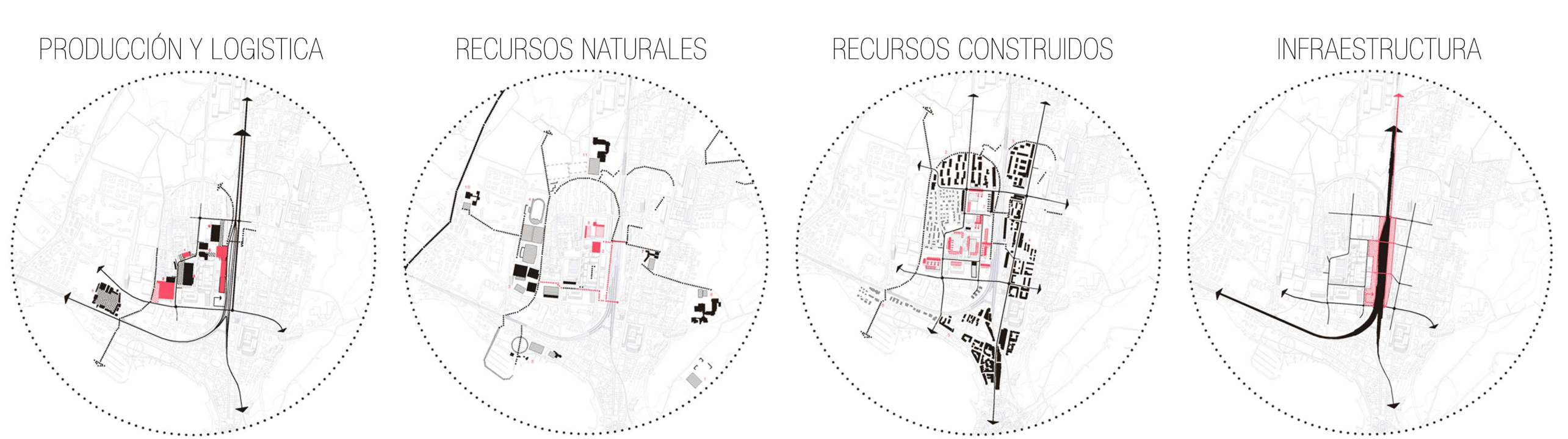

L: CIUDAD

PB

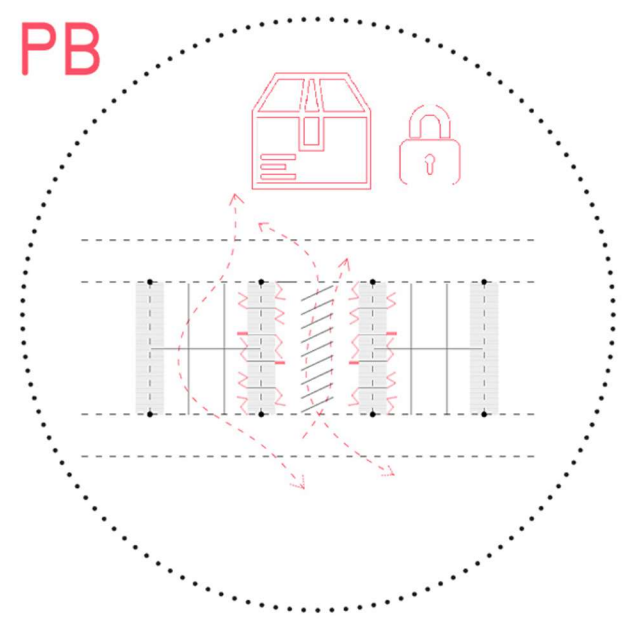

P TIPO

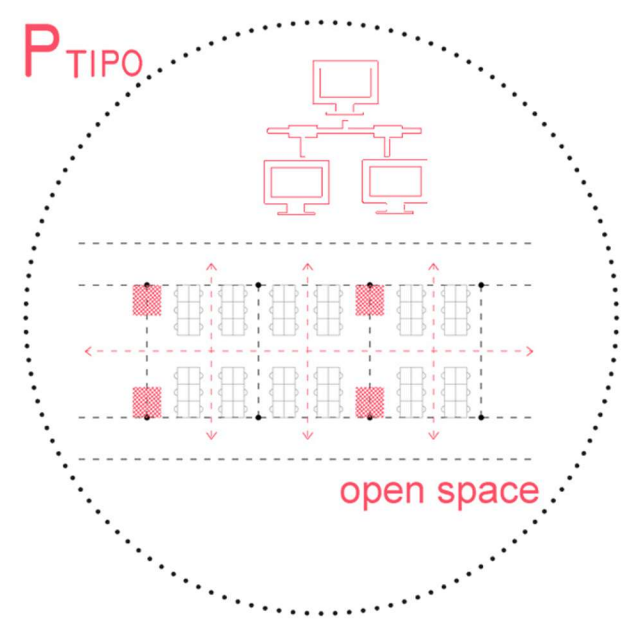

PLANTA CUBIERTA

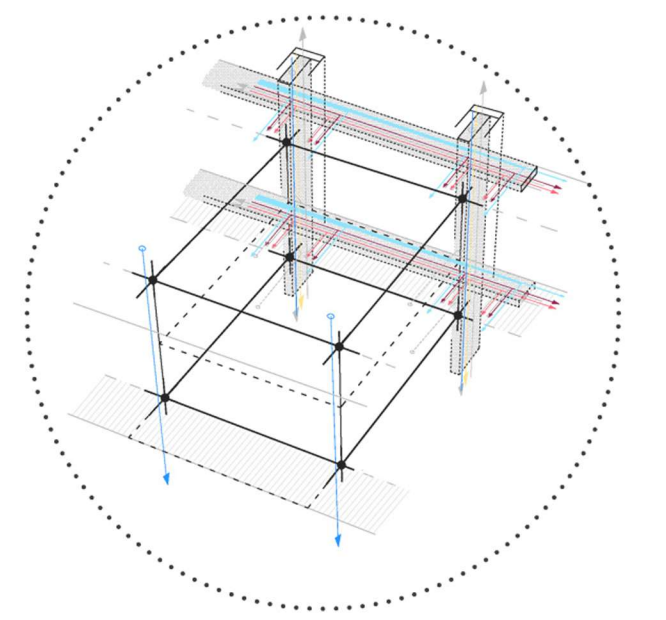
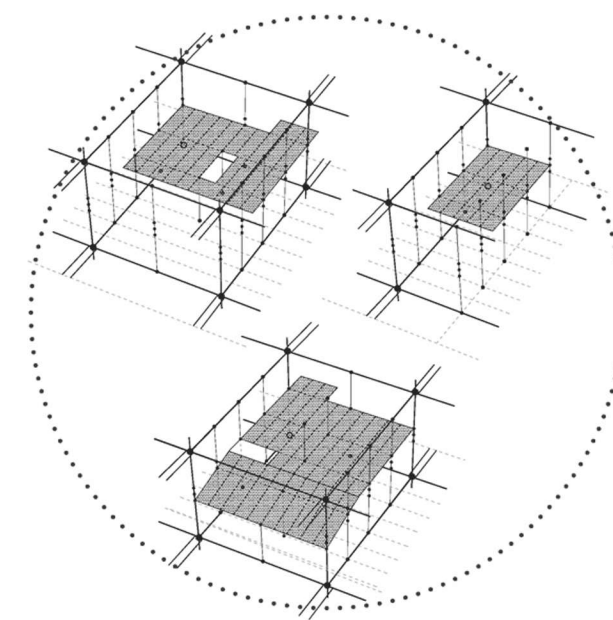
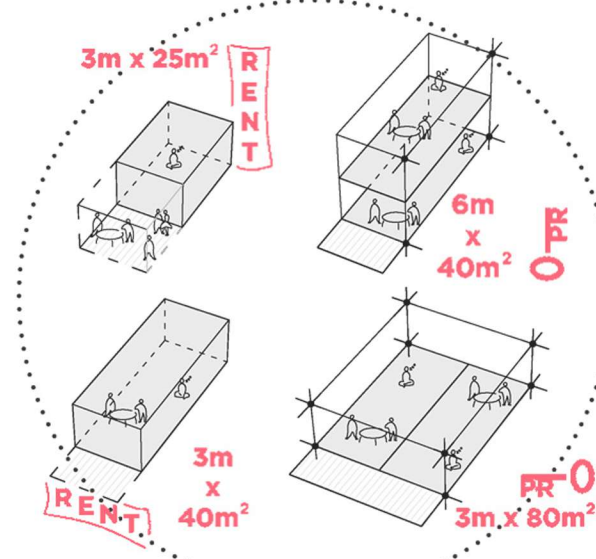
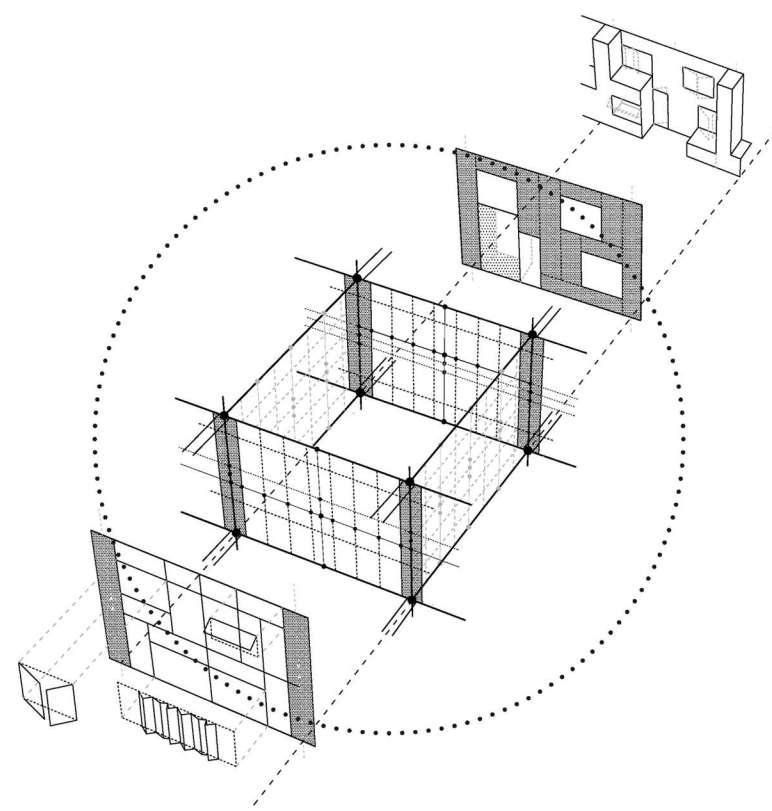
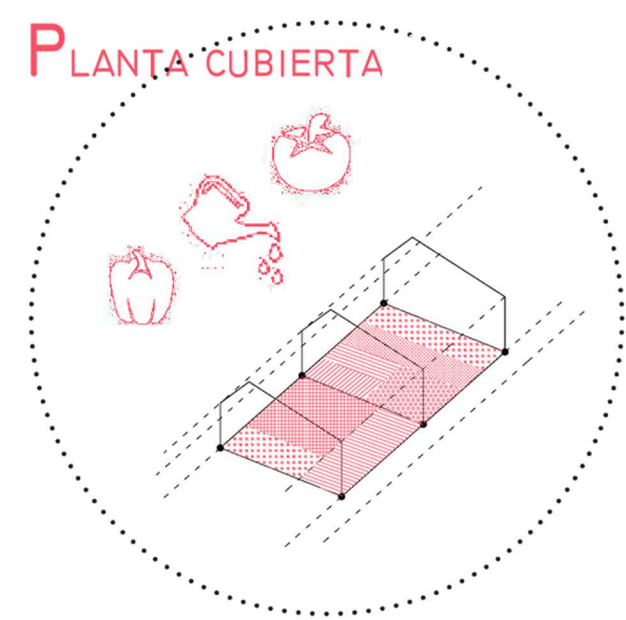

S: SOPORTE EDIFICADO II

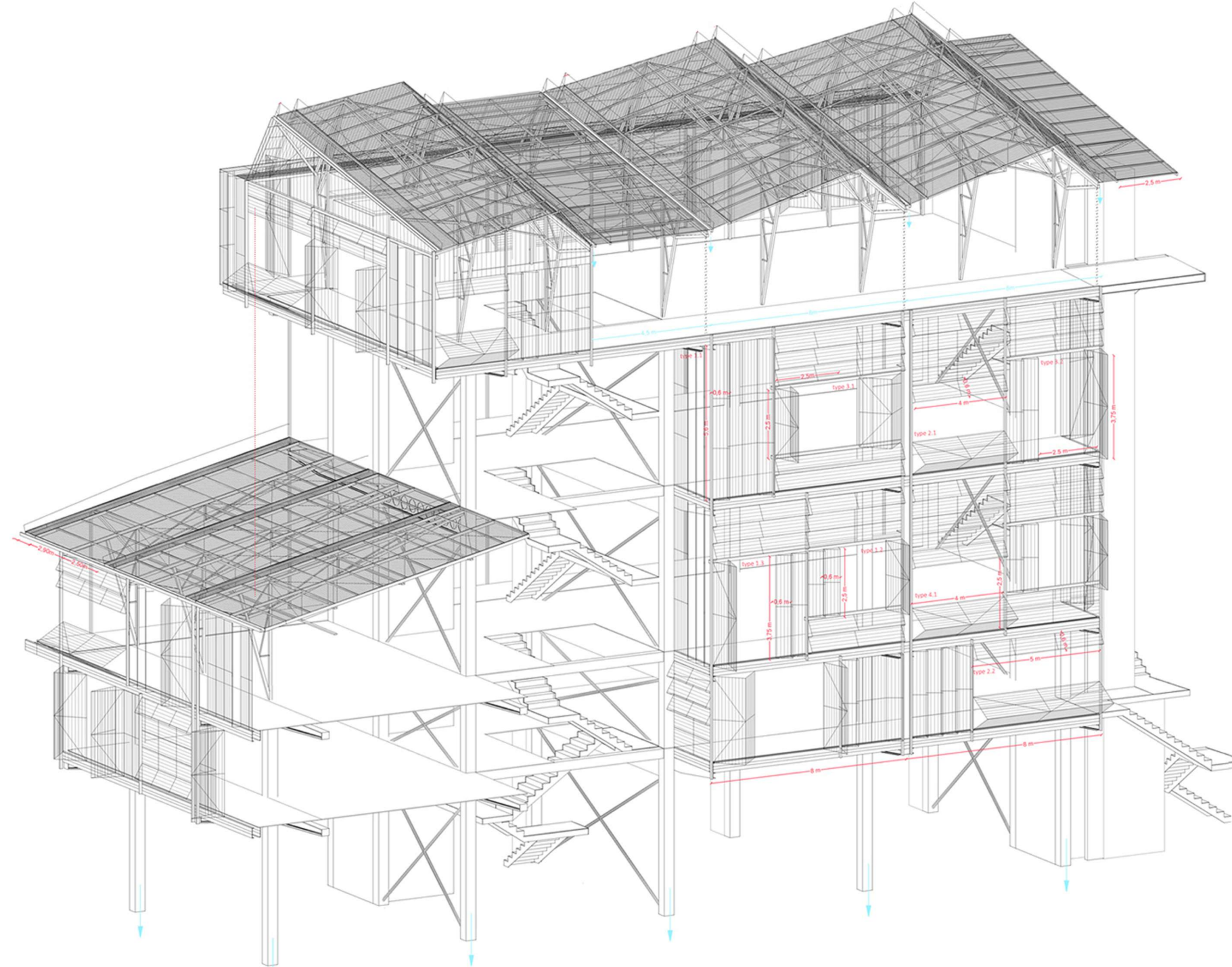
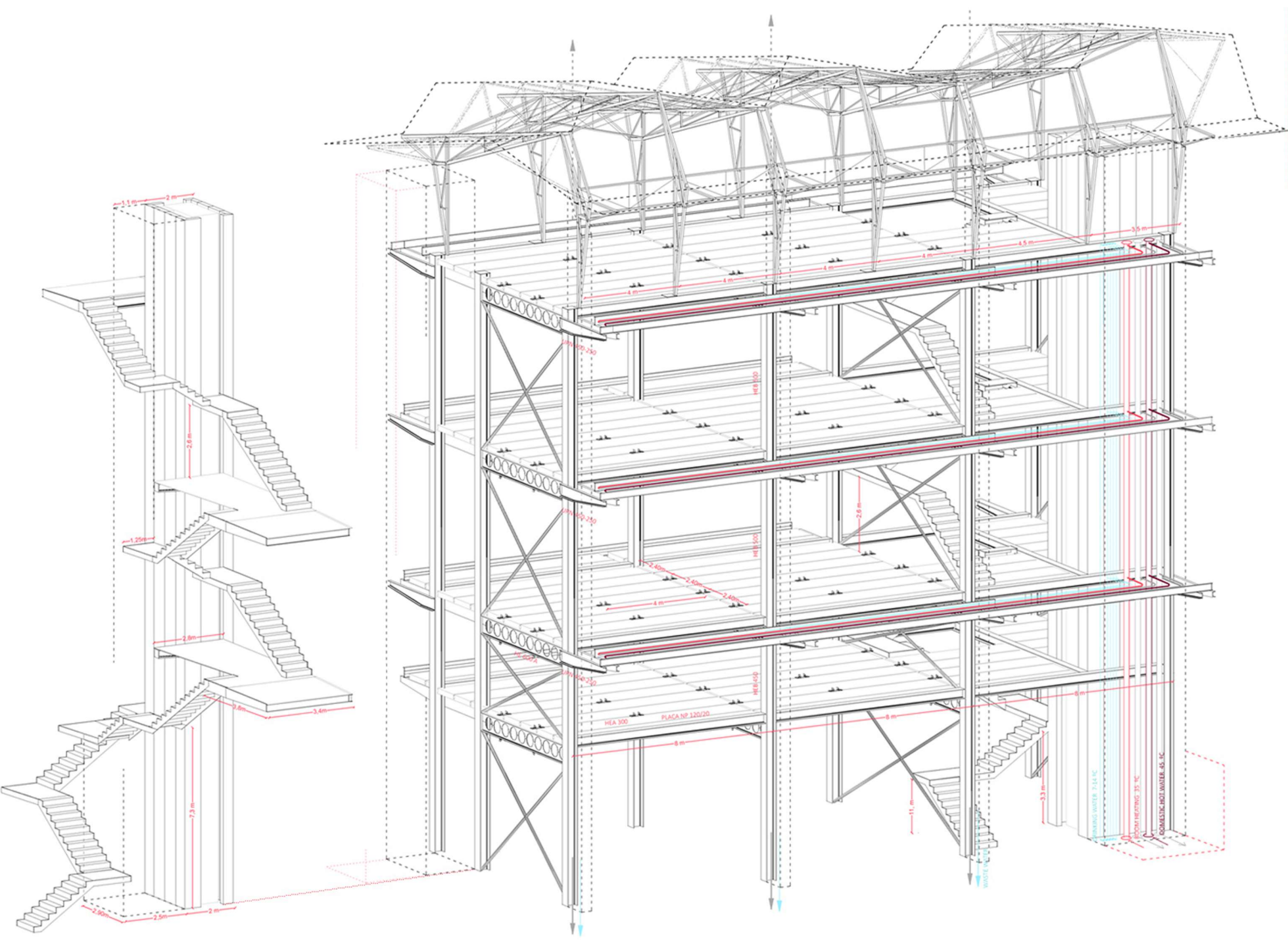

XS: VIVIENDA

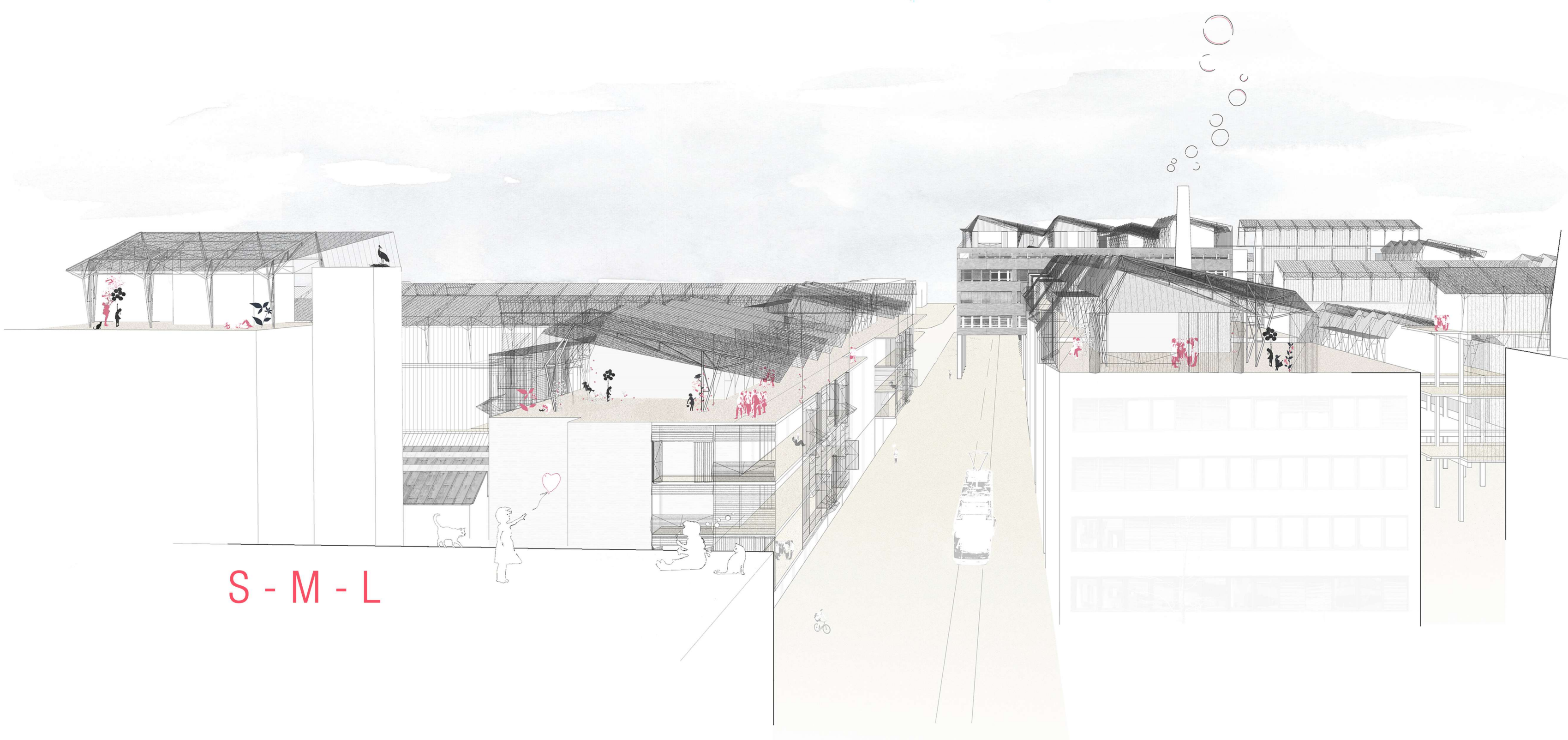
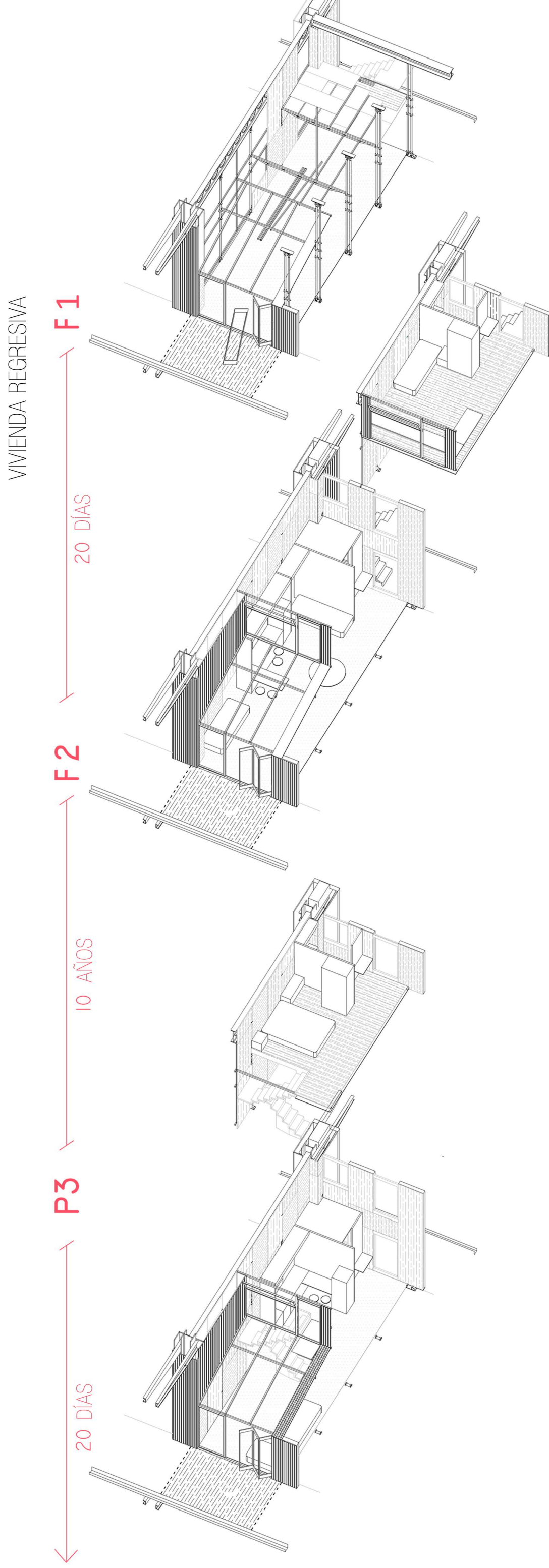

S - M - L



L - XL

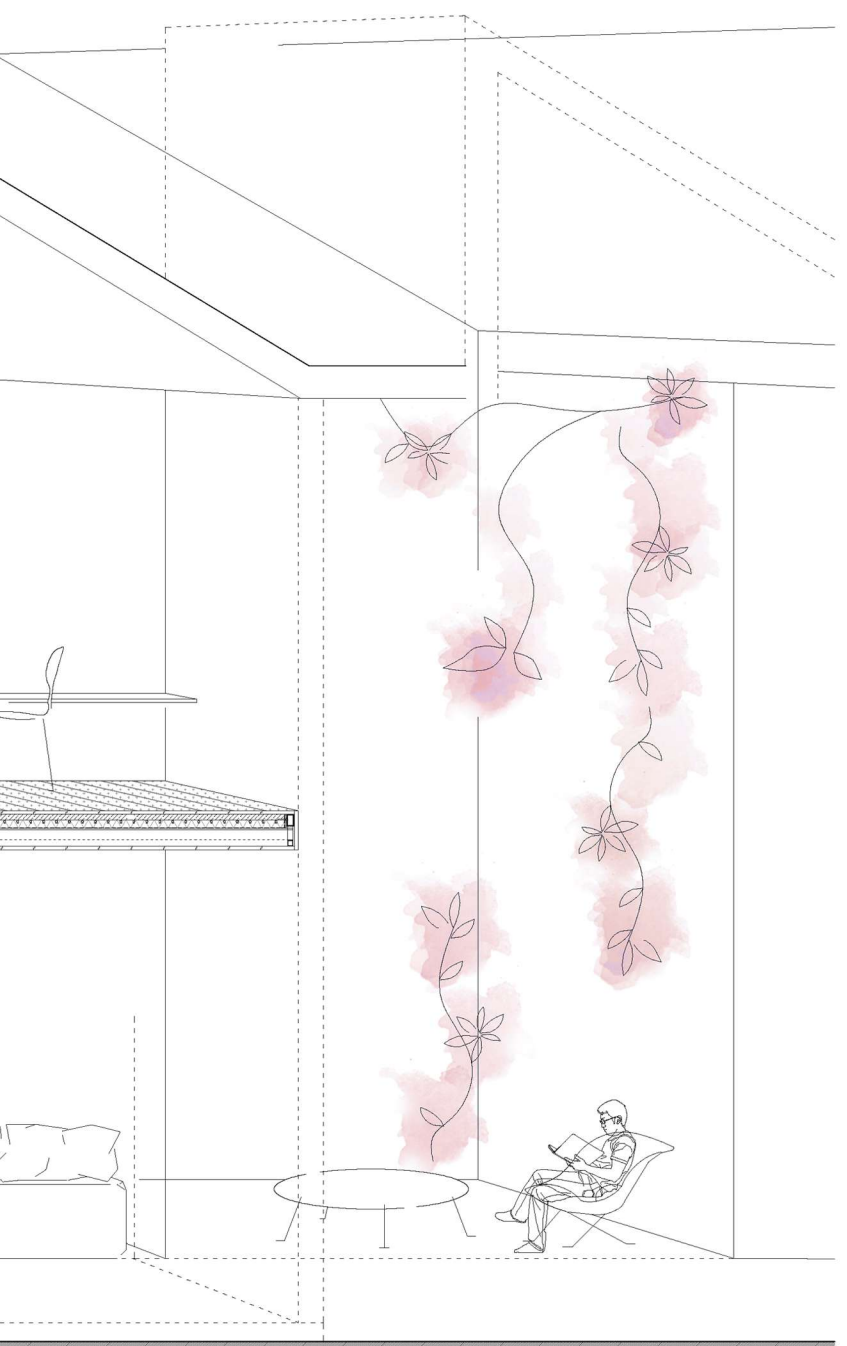

XL: TERRITORIO

