

1 **Limnimeter and Rain Gauge FDI in Sewer Networks**
2 **using an Interval Parity Equations based Detection Approach**
3 **and an Enhanced Isolation Scheme**
4

5 **Vicenç Puig, Joaquim Blesa**
6

7 *Advanced Control Systems Group (SAC), Institute of Robotics and Industrial Informatics (IRI-CSIC), Universitat*
8 *Politécnica de Catalunya (UPC), Pau Gargallo, 5, 08028 Barcelona, Spain*
9 *(e-mail: vicenc.puig@upc.edu)*
10

11 **Abstract:** In this paper, a methodology for limnimeter and rain-gauge *fault detection and isolation* (FDI)
12 in sewer networks is presented. The proposed model based FDI approach uses interval parity equations
13 for fault detection in order to enhance robustness against modelling errors and noise. They both are
14 assumed unknown but bounded, following the so-called *interval* (or *set-membership*) approach. On the
15 other hand, fault isolation relies on an algorithm that reasons using several fault signature matrices that
16 store additional information to the typical binary one used in standard FDI approaches. More precisely,
17 the considered fault signature matrices contain information about residual fault sign/sensitivity and
18 time/order of activation. The paper also proposes an identification procedure to obtain the interval models
19 used in fault detection that delivers the nominal model plus parameter uncertainty is proposed. To
20 exemplify the proposed FDI methodology, a case study based on the Barcelona sewer network is used.
21
22

23 **Keywords:** Fault detection, fault isolation, sewer networks, robust methods.
24

25 1. INTRODUCTION
26

27 Sewer networks are complex large-scale systems which require highly sophisticated supervisory-control systems to ensure
28 that high performance can be achieved and maintained under adverse operating conditions. Most cities around the world have
29 sewage systems that combine sanitary and storm water flows within the same network. This is why these networks are known
30 as *Combined Sewage Systems* (CSS). During rain storms, wastewater flows can easily overload these CSS, thereby causing
31 operators to dump the excess of water into the nearest receiver environment (rivers, streams or sea). This discharge to the
32 environment, known as *Combined Sewage Overflow* (CSO), contains biological and chemical contaminants creating a major
33 environmental and public health hazard. Environmental protection agencies have started forcing municipalities to find
34 solutions in order to avoid those CSO events. A possible solution to the CSO problem would be to enhance existing sewer
35 infrastructure by increasing the capacity of the wastewater treatment plants (WWTP) and by building new underground

36 detention tanks. But, in order to take profit of these expensive infrastructures, a highly sophisticated *real-time control* (RTC)
37 scheme is also necessary which ensures that high performance can be achieved and maintained under adverse meteorological
38 conditions (Schütze, 2004) (Marinaki, 2005). The advantage of RTC applied to sewer networks has been demonstrated by an
39 important number of researchers during the last decades. Comprehensive reviews that include a discussion of some existing
40 implementations are given by (Schilling, 1996) (Schütze, 2004) and cited references therein, while practical issues are
41 discussed by (Schütze, 2002), among other. The RTC scheme in sewage systems might be *local* or *global*. When local control
42 is applied, flow regulation devices use only measurements taken at their specific locations. While this control structure is
43 applicable in many simple cases, in a big city, with a strongly interconnected sewer network and a complex infrastructure of
44 sensors and actuators, it may not be the most efficient alternative. Conversely, a global control strategy, which computes
45 control actions taking into account real-time measurements all through the network, is likely the best way to use the
46 infrastructure capacity and all the available sensor information. The multivariable and large-scale nature of sewer networks has
47 lead to the use of some variants of Model Predictive Control (MPC), as global control strategy (Gelormino, 1994)(Cembrano,
48 2004)(Pleau, 2005) (Marinaki 2005) (Ocampo-Martínez, 2008).

49
50 The global RTC need to operate in adverse meteorological conditions involves, with a high probability, sensor and actuator
51 malfunctions (faults). This problem calls for the use of an on-line *fault detection and isolation* (FDI) system able to detect
52 such faults and correct them (if possible) by activating fault tolerance mechanisms, as the use of soft sensors or using the
53 embedded tolerance of the MPC controller, that avoids that the global RTC should be stopped every time that a fault appears.
54 According to (Schütze, 2004), this is one of the main reasons why today there is a small number of global RTC operating in the
55 world. This difficulty has also been assessed by the author when implementing the global RTC in the Barcelona sewer network
56 (Cembrano, 2004). This has motivated the research presented in this paper.

57
58 In the literature, FDI in sewer networks has already been addressed using Takagi-Sugeno multi-models in the case of rain-
59 gauges (Giuliani, 1997) and in the case of limnimeters (Boukhris 1997; 2001). Fault detection is based on checking the residual
60 against a threshold that has been derived either from statistical or empirical approaches. The use of Kalman filters and Wald
61 sequential test has been proposed by (Piatyszek et al., 2000) as means of detecting limnimeter faults in sewer networks. In all
62 these approaches, a simplified deterministic model of rainfall-runoff transformation is considered.

63
64 In the present paper, a simplified model based on the virtual tank modelling approach proposed in (Cembrano, 2004) is used to
65 model the rainfall-runoff transformation. This conceptual modelling approach based on establishing mass balances in the sewer

66 network catchments avoids the complexity of the physical oriented models based on Saint-Venant equations that are not
67 adequate to be used on-line. To consider the uncertainty in the sewer modelling due to the use of this conceptual approach, a
68 FDI approach based on *interval models and methods* is proposed (Puig, 2008). Interval methods are very appropriate when the
69 modelling uncertainty is included in the model by means of interval parameters. Moreover, noise can easily handled using the
70 interval methods since only a noise bound is required without any assumption about the statistical distribution. For both
71 reasons, interval methods can be considered as an alternative to *stochastic models and methods* (Basseville and Nikiforov,
72 2003)(Nikiforov, 1998). In Meseguer (2010), interval observers for fault detection have been already proposed for limnimeter
73 fault detection. In this paper, alternatively interval parity equations expressed in regressor form are proposed. The advantage
74 of interval parity equations with respect to observers is that the algorithm proposed in (Blesa, 2011) for estimating interval
75 parameters and generating detection thresholds can be used. Interval parity approaches are less computational demanding than
76 observers because the parameters enter linearly in the equations. This fact has already noticed by Ploix and Adrot (2006) .

77

78 In this paper, the problem of FDI is mainly focused on rain gauges and limnimeters used for the RTC of a sewer network, but
79 could easily being extended to actuator faults or faults in other elements in the network. The proposed fault detection and
80 isolation strategy is based on building an interval model for every instrument. Then, each instrument reading is compared with
81 the prediction provided by its interval model. While, the real measurement is inside the interval of predicted behaviour (or
82 envelope) generated using its interval model, no fault can be indicated. However, when the measurement is outside its
83 envelope, a fault can be indicated (Puig, 2008). Once the fault has been detected, a fault isolation procedure is initiated in order
84 to isolate the faulty instrument. The proposed FDI approach introduces also an improved interface between fault detection and
85 isolation that reasons not only using binary information about fault signal activation but also considers residual fault
86 sensitivities and time/order of activation. The need of such improved interface has been motivated because the application of
87 the standard binary interface between fault detection and isolation could lead to wrong diagnosis when the residuals present
88 different sensitivities and order/time of activation after the fault appearance (Combastel, 2003). The proposed diagnosis
89 approach in this paper comes from an evolution of the algorithm presented in (Puig, 2005). In the literature, there have also
90 appeared other proposals following the same spirit as the one proposed by (Van den Daele *et al.*, 1997) where the activation of
91 a residual generates an event with a belief and time stamp, among other attributes. Then, a reasoning using a causal graph
92 produces a set of candidate faults ranked from the most to the least probable. In the same line, (Ragot, 2006) proposed an
93 improved fault diagnosis approach based on the fuzzy evaluation of the residuals that considers not only binary information but
94 also signs/sensitivities as well as the persistence of residual activation. This approach has also been applied to a water
95 network.

96

97 To exemplify the FDI problem in sewer networks and the proposed FDI methodology, the Barcelona network is used as the
98 case study. Such network has a telemetry system containing 22 rain gauges and more than 100 limnimeters used for the RTC
99 system. In this paper, a representative part of this network is considered.

100

101 The organisation of the paper is the following: *Section 2* presents how models for FDI in rain-gauges and liminimeters are built
102 and intervals for parameters are estimated. *Section 3* overviews the proposed FDI scheme. *Section 4* and *5* discuss the
103 implementation of the fault detection and isolation modules. *Section 6* presents a description of the Barcelona sewer network
104 used as a case study and shows the results obtained using the proposed FDI scheme. Finally, *Section 7* closes the paper with
105 the conclusions.

106

107

2. INTERVAL MODELS FOR FDI IN SEWER NETWORKS

108

109 Rain gauges and limnimeters are the two type of sensors used in the RTC of sewer networks: the first type measures rain
110 intensity while the second one measures the sewer water level. In general, when detecting faults in sensors two strategies are
111 possible: *hardware redundancy* based on the use of redundant (extra) sensors and *analytical redundancy* based on the use of a
112 mathematical model that combines measurements from other correlated sensors or from the same sensor in past instants
113 (Patton, 2000). In critical systems (space aircrafts, aeroplanes, ...) hardware redundancy is preferred. But, in large scale
114 systems (as the case of sewer networks), the use of hardware redundancy is very expensive and increases the number of
115 maintenance and calibration operations. That is the reason why analytical redundancy has been proved to be a good and
116 cheaper alternative. This is the approach followed in this paper.

117

118

2.1 Modelling limnimeters

119

120 Typically, in sewer networks, sewage level is measured instead of flow. There are two reasons that can explain this fact. First
121 since the level is measured using ultrasonic waves, limnimeters do not have contact with the sewage flow (Fig. 1), and
122 consequently, the required maintenance is cheaper. Second, limnimeters are cheaper than flowmeters. Ultrasonic limnimeters
123 generates an acoustic pulse that is transmitted from the transducer and then it is reflected back from the surface of the liquid.
124 The transit time is then converted into the current output, which is directly proportional to the fluid level. From level
125 measurements, the flow in a sewer can be estimated assuming steady-uniform flow and using the Manning formula calibrated

126 using experimental data (Duchesne, 2001). However, as also discussed in (Duchesne, 2001), where there is not enough slope
127 in the sewer, the backwater effect could appear leading to a complex relation between flow and level that can not be explained
128 by a static relation as the Manning formula. In the sewer network locations where the backwater effect is important, the use of
129 a flow meter instead of a limnimeter is advisable.

130
131 Limnimeters can be monitored in rain scenarios¹ using an on-line rainfall-runoff model of the sewer network that characterizes
132 the net rainfall entering as flow in the sewers. The water flow in sewers due to runoff is open-channel. The Saint-Venant
133 equations, based on physical principles of mass conservation and energy, allow describing accurately the open-channel flow in
134 a sewer (Marinaki, 2005). Such complex non-linear rainfall-runoff models are very useful for off-line operations (calibration
135 and simulation) of the sewer network. But for on-line purposes, as the global optimal control and FDI, a simpler conceptual
136 model must be used (Duchesne, 2001). One possible modelling methodology to derive a rainfall-runoff real-time model of a
137 sewer network is based on using a simplified graph relating the main sewers and catchments as a set of virtual reservoirs
138 (Cembrano, 2004).

139



140

141

142 Fig. 1. Limnimeter inside a sewer

143

144 A *virtual reservoir* is an aggregation of a sewer capacity in a catchment of the sewer network which approximates the
145 hydraulics of rain infiltration, runoff and sewage water retention thereof (Fig. 2).

146

¹ In dry scenarios, to monitor limnimeters a different modelling approach (based on time series) could be used to exploit the temporal redundancy existing in the sensor measurements. These measurements follow the patterns of consumer drinking water demands with daily and weekly cycles as the flow meters in a drinking water network. In Quevedo et. al (2010), an approach to detect faults in flow meters in a drinking water network.

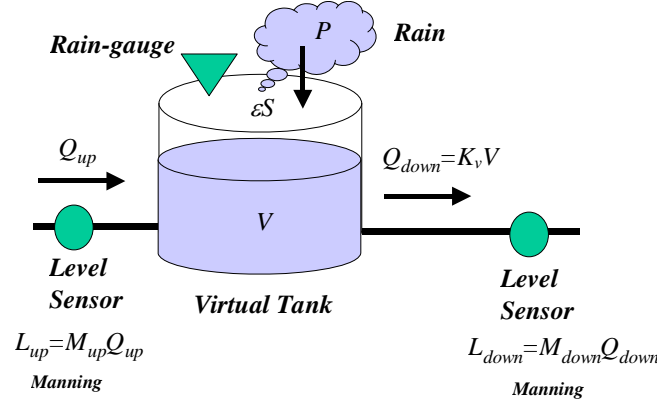

Fig. 2. Virtual reservoir model of a catchment

The hydraulics of a virtual reservoir that models a catchment is given by

$$\frac{dV(t)}{dt} = Q_{up}(t) - Q_{down}(t) + \varepsilon P(t)S \quad (1)$$

where: V is the volume of water accumulated in the catchment, Q_{up} and Q_{down} are flows entering and exiting the catchment, P is the rain intensity falling in the catchment, S its surface and ε the ground absorption coefficient. Upstream and downstream sewage levels (L_{up}, L_{down}) are measured using limnimeters and they can be related with upstream/downstream flows (Q_{up}, Q_{down}) using a linearised Manning relation:

$$Q_{up}(t) = M_{up} L_{up}(t) \quad (2)$$

$$Q_{down}(t) = M_{down} L_{down}(t) \quad (3)$$

where M_{up}, M_{down} are the limnimeter Manning coefficients estimated experimentally.

It is additionally assumed that the catchment behave as a linear virtual tank, i.e., that a linear relation between the volume of the water stored in the virtual tank is linearly related with the flow downstream the catchment

$$Q_{down}(t) = K_v V(t) \quad (4)$$

where K_v is the volume/flow conversion coefficient estimated experimentally as well.

Then, substituting (4) in (1) and discretising using the Euler method with a sampling time Δt , the following discrete-time relation (k is the discrete time) between upstream and downstream flows can be derived:

$$Q_{down}(k+1) = (1 - K_v \Delta t) Q_{down}(k) + K_v \Delta t Q_{up}(k) + K_v \Delta t \varepsilon S P(k) \quad (5)$$

169 Finally, replacing (2) and (3) in (5), leads to the following relation between upstream and downstream limnimeter
 170 measurements

$$171 \quad L_{down}(k+1) = aL_{down}(k) + bL_{up}(k) + cP(k) \quad (6)$$

172
 173 where:

$$174 \quad a = (1 - K_v \Delta t), \quad b = \frac{M_{up} K_v \Delta t}{M_{down}} \quad \text{and} \quad c = \frac{K_v \Delta t \epsilon S}{M_{down}}$$

175
 176 **2.2 Modelling rain-gauges**

177
 178 Typical rain-gauges used in sewer networks are of tipping bucket type (see Figure 3(a)). This gauge technology uses two small
 179 buckets mounted on a fulcrum (balanced like a see-saw) (see Figure 3(b)). The tiny buckets are manufactured with tight
 180 tolerances to ensure that they hold an exact amount of precipitation. The tipping bucket assembly is located above the rain
 181 sewer, which funnels the precipitation to the buckets. As rainfall fills the tiny bucket, it becomes overbalanced and tips down,
 182 emptying itself as the other bucket pivots into place for the next reading. The action of each tipping event triggers a small
 183 switch that activates the electronic circuitry to transmit the count to the indoor console, recording the event as a given number
 184 of *mm/h* of rainfall. The number of tipping events in a pre-established sampling time is accumulated and multiplied by a factor
 185 in order to obtain the rain intensity in *m/s* at each sampling time, after the appropriate unit conversion.

186

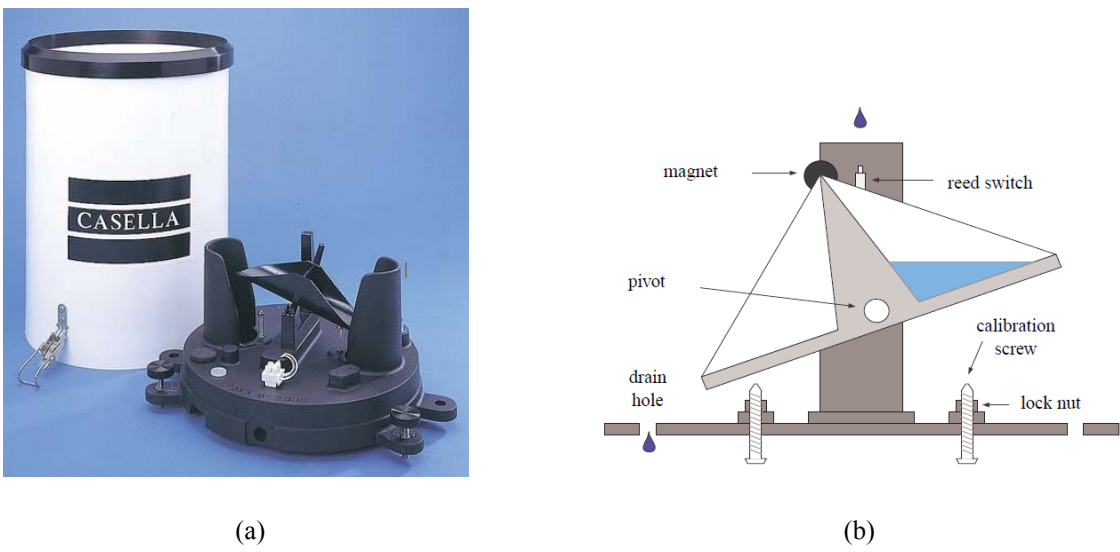

187
 188 (a)
 189 (b)
 190 Fig. 3. (a) A rain-gauge manufactured by Casella Measurement and (b) Principle of operation of a tipping bucket rain-gauge

191 In order to detect faults in a given rain-gauge P_i , a model that exploits *spatial redundancy* existing in the rain-gauge network is
 192 used. The model relates the measurements of rain-gauge P_i with the m most-correlated rain-gauges (P_1, \dots, P_m) at time instant k
 193 as follows

$$194 \quad P_i(k) = \alpha_1 P_1(k) + \alpha_2 P_2(k) + \dots + \alpha_m P_m(k) \quad (7)$$

195 The most correlated rain-gauges correspond to the ones that are the closest in distance as discussed in (Figueras et al., 2005).

196 2.3 Estimation of interval models 197

198
 199 One of the key points in using the interval model based fault detection is how intervals of model parameters are estimated from
 200 scenarios free of faults. The estimation process should deliver a nominal model plus its modelling error in the form of interval
 201 parameters that will provide an interval of confidence for the predicted behaviour. Several authors ((Ploix, 1999) (Calafiore,
 202 2002)(Campi, 2009)) have suggested an adaptation of standard system identifications methods to provide the nominal model
 203 plus the uncertainty intervals for parameters that guarantee that all recorded data from the system in non-faulty scenarios will
 204 be included in the interval model. These algorithms are based on using standard identification methods (for example, least-
 205 squares) to provide the nominal estimate for system parameters. Then, the intervals of uncertainty for parameters are adjusted
 206 until all the measured data is covered by the model prediction interval.

207
 208 The algorithm proposed in this paper considers that the interval model to be identified can be expressed in regressor form as
 209 follows

$$210 \quad y(k) = \boldsymbol{\varphi}(k)\boldsymbol{\theta}(k) + e(k) \quad (8)$$

211 where: $\boldsymbol{\varphi}(k)$ is the regressor vector of dimensions $1 \times n_\theta$ which can contain any function of inputs ($u(k), u(k-1), u(k-2), \dots$)
 212 and outputs ($y(k), y(k-1), y(k-2), \dots$), $e(k)$ is additive noise bounded by a constant $|e(k)| \leq \sigma$, $\boldsymbol{\theta}(k) \in \Theta$ is the parameter
 213 vector of dimensions $n_\theta \times 1$ and Θ is an interval box centred in the nominal parameter values $\Theta \triangleq [\theta_1] \times \dots \times [\theta_i] \times \dots \times [\theta_{n_\theta}]$
 214 where $[\theta_i] \triangleq [\theta_i^0 - \lambda_i, \theta_i^0 + \lambda_i]$, $i=1, \dots, n_\theta$, with θ_i^0 being the nominal parameter values and $\lambda_i \geq 0$ the parameter
 215 uncertainties. The uncertain interval parameter set Θ can be parameterised as a particular case of a zonotope (Blesa et al,
 216 2011) as follows:

$$217 \quad \Theta = \{ \boldsymbol{\theta}^0 + \mathbf{H}\mathbf{z} : \mathbf{z} \in \mathbf{B}^n \} \quad (9)$$

218 with centre $\boldsymbol{\theta}^0$ and matrix uncertainty shape \mathbf{H} equal to a $n_\theta \times n_\theta$ diagonal matrix:

$$219 \quad \boldsymbol{\theta}^0 = (\theta_1, \theta_2, \dots, \theta_{n_\theta})$$

$$\mathbf{H} = \text{diag}(\lambda_1, \lambda_2, \dots, \lambda_{n_0})$$

and $\mathbf{B}^n \in \mathbb{R}^{n \times 1}$ is a unitary box composed by n unitary ($\mathbf{B} = [-1, 1]$) interval vectors where $n = n_0$.

Then, proceeding as in Blesa et al (2011), the maximum and minimum values of the prediction provided by model (8) with uncertain parameter set (9) are given by

$$\bar{\hat{y}}(k) = \hat{y}^0(k) + \|\mathbf{H}\boldsymbol{\varphi}(k)\|_1 \quad (10)$$

$$\underline{\hat{y}}(k) = \hat{y}^0(k) - \|\mathbf{H}\boldsymbol{\varphi}(k)\|_1 \quad (11)$$

where $\hat{y}^0(k)$ is the model output prediction with nominal parameters: $\hat{y}^0(k) = \boldsymbol{\varphi}(k)\boldsymbol{\theta}^0$. In the particular case of interval

parameters: $\|\mathbf{H}\boldsymbol{\varphi}(k)\|_1 = \sum_{i=1}^n \lambda_i |\varphi_i(k)|$.

Then, given a sequence of data in a fault free scenario (measurements of regressor vector $\boldsymbol{\varphi}(k)$ and output $y(k)$ for $k = 1, \dots, N$) and rich enough from the identifiability point of view, the estimation problem boils down in determining the nominal parameter vector ($\boldsymbol{\theta}^0$) and the parameter uncertainty (defined by matrix \mathbf{H}) in such a way that all the measurements are inside the prediction interval (given by bounds (10) and (11)) and, the size of intervals for parameters is minimised.

The identification of $\boldsymbol{\theta}^0$ and \mathbf{H} can be carried out in two steps: In the first step, nominal vector parameter can be identified (by conventional methods, i.e least squares). Then, in the second the parameter uncertainties defined by \mathbf{H} can be computed.

From equations (10) and (11), the smallest intervals for parameters that satisfy $y(k) \in [\underline{\hat{y}}(k), \bar{\hat{y}}(k)]$ for $k = 1, \dots, N$ can be computed solving the following optimization problem

$$\min_{\mathbf{H}} \text{vol}(\boldsymbol{\Theta}(\mathbf{H}))$$

$$\text{subject to: } \hat{y}^0(k) + \|\mathbf{H}\boldsymbol{\varphi}(k)\|_1 \geq y(k) - \sigma \quad k = 1, \dots, N \quad (12)$$

$$\hat{y}^0(k) - \|\mathbf{H}\boldsymbol{\varphi}(k)\|_1 \leq y(k) + \sigma$$

In order to reduce the complexity of the optimization problem (12), the uncertain parameter set $\boldsymbol{\Theta}$ can be parameterised such that a pre-determined shape \mathbf{H}_0 , as proposed in Blesa et al (2011), is used. The shape \mathbf{H}_0 can be estimated, for example, from the parameter variance of estimated nominal model: $\mathbf{H} = \lambda\mathbf{H}_0$. Other heuristics could also be used (for more details see Blesa et al (2011)).

In the case of considering $\mathbf{H} = \lambda\mathbf{H}_0$, the optimal solution of (12) is provided by:

$$\lambda = \sup_{k \in \{1, \dots, N\}} \left(\frac{|y(k) - \hat{y}^0(k)| - \sigma}{\|\boldsymbol{\varphi}(k)\mathbf{H}_0\|_1} \right) \quad (13)$$

3. OVERVIEW OF THE PROPOSED FDI SCHEME

3.1 Introduction

The standard FDI scheme is based on generating a set of numerical fault indicators, known as *residuals* which are computed using analytical redundancy relations (obtained from model equations) and the measured inputs and outputs of the monitored system. Then, the fault detection task consists in deciding if there is a fault affecting the monitored system by checking each residual against a threshold that takes into account model uncertainty, noise and the unknown disturbances. The result of this test applied to every residual produces an *observed fault signature*. The observed fault signature is supplied to the fault isolation module that will try to isolate the fault by looking at theoretical binary fault signature matrix where a binary relation between the considered fault hypothesis set. However, when applying this standard FDI scheme to limnimeters and rain-gauges in sewers networks, the following drawbacks were noticed:

- (a) The detection threshold should be determined and adapted on-line according to the system inputs and outputs taking into account the model uncertainty.
- (b) The presence of the noise produces chattering if a binary evaluation of the residual is used.
- (c) All residuals affected by a certain fault should be activated at the same time instant and they should be persistently keeping activated during the whole fault isolation process. Otherwise, a wrong fault diagnosis result could be given.
- (d) Restricting the relation between faults and fault signals to a binary one causes a loss of useful information that can add fault distinguishability and accurateness to the fault isolation algorithm preventing possible wrong fault diagnosis results.

3.2 Proposed FDI scheme

To deal with the previous issues, the FDI scheme, presented in Figure 4, is proposed. This scheme is composed of different modules that play the following role (Fig. 4):

- *Fault detection module* is based on evaluating the residual against an adaptive threshold generated evaluating the interval parity equations that evolves along time taking into account model uncertainty and noise (Puig, 2008) (see *Section 4* for more details).
- *Fault detection/isolation interface module* evaluates fault signals generated by the fault detection module in order to isolate the fault among the considered fault hypotheses using several indicators which take into account not only the activation value of the fault signal but also its fault sensitivity/sign and its activation time/order. This improved interface module try to handle the problems associated with the fault signal persistency, the residual sensitivity to a fault, the fault signal occurrence order and the fault signal occurrence time instant (see *Section 4 and Appendix 1* for more details).
- *Fault isolation module* reasons with the information provided by all the indicators/fault signature matrices to achieve the fault isolation (see *Section 5* for more details).

The underlying assumptions considered in the proposed FDI approach are that no multiple faults (“*single fault hypothesis*”) and faults can be modelled in an additive way as in the standard FDI approaches (Gerlter, 1998).

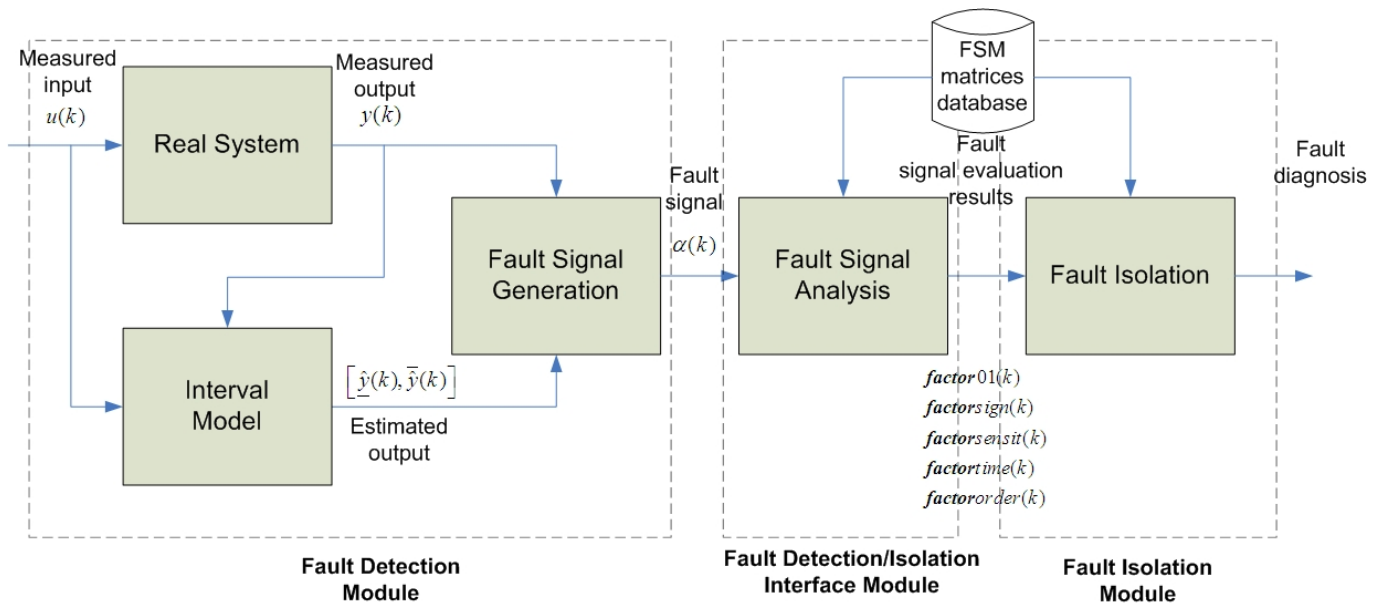

Fig. 4. FDI proposed scheme

4. FAULT DETECTION MODULE AND INTERFACE WITH FAULT ISOLATION MODULE

4.1 Fault detection module

The fault detection module is based on the evaluation of the nominal residual obtained from difference between measurements and model prediction using model in regressor form (8)

294
$$r^o(k) = y(k) - \hat{y}^o(k) = y(k) - \boldsymbol{\varphi}(k)\boldsymbol{\theta}^o \quad (14)$$

295 where $\boldsymbol{\theta}^o$ are the nominal parameters.

296 Taking into account parametric modelling errors, the detection test consists in evaluating the following condition

297
$$r_i^o(k) \in \left[\underline{r}_i^o(k), \overline{r}_i^o(k) \right] \quad (15)$$

298 where: $\underline{r}_i^o(k) = \underline{\hat{y}}_i(k) - \hat{y}_i^o(k)$ and $\overline{r}_i^o(k) = \overline{\hat{y}}_i(k) - \hat{y}_i^o(k)$ while $\underline{\hat{y}}_i(k)$ and $\overline{\hat{y}}_i(k)$ are the bounds of the i^{th} -system output
 299 prediction calculated using (10) and (11).
 300

301 Test condition (15), equivalently, can be expressed as follows:

302
 303
$$y_i(k) \in \left[\underline{\hat{y}}_i(k), \overline{\hat{y}}_i(k) \right] \quad (16)$$

304 4.2 Minimum detectable

305 The effect of faults in the residual can be expressed in terms of the residual fault sensitivity that leads to the residual internal
 306 form (Gertler, 1998). In case of considering additive input (f_u) and output (f_y) sensor faults, the computational form of the
 307 residual (14) can be expressed as follows:

308
$$r^o(k) = S_{f_y}(q^{-1})f_y(k) + S_{f_u}(q^{-1})f_u(k) \quad (17)$$

309 where $S_{f_y}(q^{-1})$ and $S_{f_u}(q^{-1})$ are the residual fault output and input sensitivity transfer functions. Considering residual (14),

310 the sensitivities are given by: $S_{f_y}(q^{-1}) = 1 - \frac{\partial \boldsymbol{\varphi}(k)}{\partial f_y} \boldsymbol{\theta}^o$ and $S_{f_u}(q^{-1}) = -\frac{\partial \boldsymbol{\varphi}(k)}{\partial f_u} \boldsymbol{\theta}^o$.

311 According to Gertler (1998), the *minimum detectable fault* $f_i^{\min}(k)$ corresponds to a size of fault that brings a residual (15) to
 312 its threshold (“*triggering limit*”), assuming that no other faults and nuisance inputs are present.

313 When using the fault detection (16) (or (15)), a fault $f(k)$ will always be detected when its fault effect ($\delta_f(k)$) is bigger than
 314 the interval prediction thickness ($\delta_r(k)$). In the case of using model (8) with parameters (9), they can be computed according

315 to (Blesa *et al.*, 2011) as follows: $\delta_f(k) = S_f(q^{-1})f(k)$ and $\delta_r(k) = 2\|\boldsymbol{\varphi}(k)\mathbf{H}\|_1 + 2\sigma$ where $S_f(q^{-1})$ is the residual fault
 316 sensitivity transfer function that characterizes the effect of fault in the residual. Then the minimum detectable fault can be
 317 computed as

318
$$\left| f_f^{\min}(k) \right| = \frac{2\|\boldsymbol{\varphi}(k)\mathbf{H}\|_1 + 2\sigma}{\left| S_f(q^{-1}) \right|} \quad (18)$$

319 Notice that minimum detectable fault defined by Eq. (17) is not a constant value, but a value that evolves dynamically and

320 depends on the operation point (defined by $\varphi(k)$). Then, the *minimum steady state detectable fault* can be obtained considering
 321 $S_f(q^{-1})|_{q=1}$ in Eq (18). Analogously, the *minimum initial detectable fault* can be obtained considering $S_f(q^{-1})|_{q \rightarrow \infty}$ in (18).

322
 323 *4.2 Interface between fault detection and isolation*
 324

325 The fault detection test (16) relies on the comparison of the nominal residual $r_i^o(k)$, which may be affected by noise, with its
 326 associated adaptive threshold (interval $[\underline{r}_i^o(k), \bar{r}_i^o(k)]$). This binary procedure may lead to undesirable decision instability
 327 (chattering) because of the effect of noise on the sensor measurements. Such as indicated by the DMP-approach (Petti et al.,
 328 1990), a gradual reasoning based on the use of fuzzy evaluation is an appealing alternative to bypass this chattering
 329 phenomenon. Then, the *fault diagnostic signal* (or *fault signal*) for each residual is calculated in the approach presented in this
 330 paper using the Kramer function (Petti et al., 1990):

$$331 \quad \phi_i(k) = \begin{cases} \frac{(r_i^o(k) / \bar{r}_i^o(k))^4}{1 + (r_i^o(k) / \bar{r}_i^o(k))^4} & \text{if } r_i^o(k) \geq 0 \\ -\frac{(r_i^o(k) / \underline{r}_i^o(k))^4}{1 + (r_i^o(k) / \underline{r}_i^o(k))^4} & \text{if } r_i^o(k) < 0 \end{cases} \quad (19)$$

332 The appealing performance of this function is due to the grading that introduces when evaluating the residual in order to
 333 conclude about the fault existence. When using Eq. (19), the residuals are normalized to a metric between -1 and 1,
 334 $\phi_i(k) \in [-1, 1]$, which indicates the degree of satisfaction of Eq. (16) for every nominal residual $r_i^o(k)$: 0 for perfectly
 335 satisfied, 1 for severely violated high and -1 for severely violated low.

336
 337 **5. FAULT ISOLATION MODULE**
 338

339 The fault isolation module used in this paper derives from the one used proposed in (Puig et al., 2005) (see Figure 5). The first
 340 component is a memory that stores information about the fault signal occurrence history and the fault detection module updates
 341 it cyclically. The pattern comparison component compares the memory contents with the stored fault patterns. The standard
 342 Boolean fault signature matrix concept (Gertler, 1998) is generalized taking into account more fault signal properties. The last
 343 component represents the decision logic part of the method which aim is to propose the most probable fault candidate.

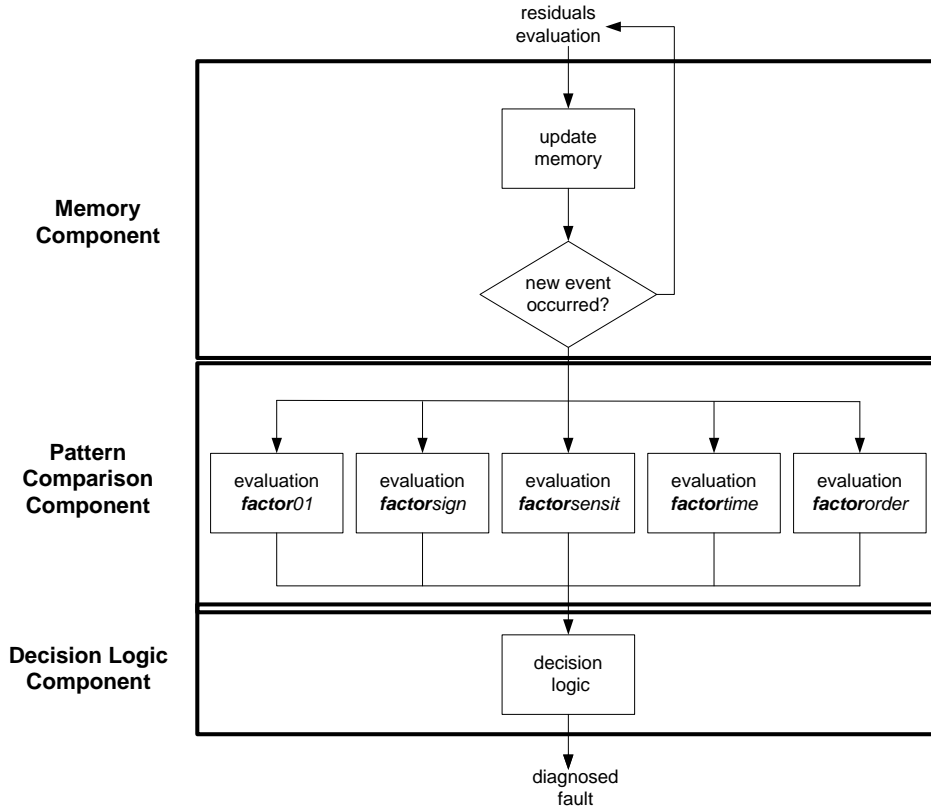

Fig. 5. Fault isolation module components

5.1 Memory component

The memory component consists of a table in which events in the residual history are stored. For each row, the first column stores the event occurrence time t_i , the second one stores the *maximum activation value* $\phi_{i,\max}$ computed according to

$$\phi_{i,\max} = \max_{k \in [k_o, k_o + T_w]} (|\phi_i(k)|) \quad (20)$$

for every fault signal, and the last one stores the *sign* of the residual. Fault signals with $|\phi_{i,\max}| < 0.5$ are filtered out. Using this strategy the effect of noise and non-persistent fault indicators are filtered because just the peaks of activation are stored. If the fault detection component detects a new residual event (that is, $|\phi_i(k)| \geq 0.5$), the memory component table is updated by adding a new row that contains all previous event information. The problem of different time instant appearance of fault signals $\phi(k)$ is solved not indicating the isolation decision until a prefixed waiting time T_w has elapsed from the first fault signal appearance. This T_w is calculated from the larger transient time response T_t from non-faulty situation to any faulty situation. After this time has elapsed, a diagnosis is proposed and the memory component is reset being ready to start the diagnosis of a new fault. Inside this diagnosis window, the maximum activation value of the memory-table $\phi_{i,\max}$

360 corresponding to residual i changes only if the current activation value $\phi_i(k_0)$ is superior to the previous ones according to
361 (20).

362

363 5.2 Pattern comparison component

364

365 The pattern comparison component compares the memory contents with the stored fault patterns. Given a set of residuals, r_i^0 ,
366 and the considered set of faults $F = \{f_1, f_2, \dots, f_j, \dots, f_m\}$, each r_i^0 is affected by a subset of these faults. The fault patterns are
367 organized according to a theoretical fault signature matrix, named **FSM**. An element FSM_{ij} of the matrix contains the pattern if
368 f_j is expected to affect r_i^0 , otherwise, it is equal to 0. This interpretation assumes that the occurrence of f_j is observable in r_i^0 ,
369 hypothesis known as *fault exoneration* or no *compensation*, and that f_j is the only fault affecting the monitored system. Five
370 different fault signature matrices are considered in the evaluation task: Boolean fault signal activation (**FSM01**), fault signal
371 signs (**FSMsign**), fault residual sensitivity (**FSMsensit**), and, finally, fault signal occurrence order (**FSMorder**) and time
372 (**FSMtime**). These matrices can be obtained from the analysis of residual fault sensitivity (17). Details on how the general
373 rules to obtain those matrices from (19) are derived can be found in (Meseguer, 2007;2009). In the *Appendix 2*, the detailed
374 definition and usage of these matrices is presented.

375

376 5.3 Decision logic component

377

378 The decision logic algorithm starts when the first residual is activated (that is, $|\phi_i(k)| \geq 0.5$) and lasts T_w time instants or till all
379 fault hypotheses except one are rejected because they do not fulfil the observed residual activation order/time or because an
380 unexpected activation signal has been observed according to those fault hypotheses. Rejection is based on using the results of
381 **factor01_j**, **factor_{signj}** and **factor_{orderj}**. That is the case, if any of these factors is 'zero' for a given fault hypotheses, it will be
382 rejected. Every factor represents some kind of filter, which only lets slip through the possible fault hypotheses. At the end of
383 the time window T_w , for each non-rejected fault hypothesis, a fault isolation indicator is calculated using the factors
384 **factor_{sensitj}** and **factor_{timej}**. Thus, the biggest fault isolation indicator will determine the diagnosed fault. The fault isolation
385 indicator associated to the fault hypothesis f_j is determined as it follows:

386

$$387 \quad d_j = \max(|\mathbf{factor}_{sensit_j}|, \mathbf{factor}_{time_j}) \quad (21)$$

388

389 So, the final diagnosis result can be expressed as a set of fault candidates with their associated fault isolation indicator.

391 5.4 Comparison with existing approaches

392 The fault isolation approach presented in this paper has been compared in (Puig, 2005) with other approaches commonly used
393 in the literature, namely:

- 394 • the standard FDI binary approach (Gertler, 1998) based on looking for a column of the fault signature matrix that
395 matches the observed fault signature (called *column reasoning* in Cordier *et al.* (2004))
- 396 • the DX approach based of reasoning only with the activated fault signals and the corresponding rows of the fault
397 signature matrix (called *row reasoning* in Cordier *et al.*, (2004),
- 398 • the DMP approach proposed by Petti *et al.* (1990) that only reasons with the fault residual sensitivity (*FSM_{sensit}*) and
- 399 • the DTS approach proposed by Kóscielny (1995) that uses the knowledge about the times in which fault signal should
400 be activated after the fault is detected. This approach looks at a row of the fault signature matrix only after its fault
401 signal detection time has elapsed (similar to row reasoning approach). But, in this way it is looking step-by-step at all
402 rows, counting ones and zeros (similar to column reasoning approach).

403 The comparison in Puig *et al.* (2005) has been done using the well known two tank system described in Blanke *et al.* (2006),
404 considering six different faults in scenarios with different fault sizes. Two performance criteria have been used for comparison:

- 405 • The *diagnostic resolution* defined as the average number of valid fault hypotheses per diagnosis, and the best possible
406 value is 1.
- 407 • The *diagnostic error rate* defined as the average percentage of wrong diagnoses. An error rate of 0 is desirable.

408 Thus, the optimal point in the error rate/diagnostic resolution-plane is (0/1). Figure 6 shows how the different methods are
409 positioned in this plane. It can be noticed that the proposed method is the one that approaches the most to the optimal point.

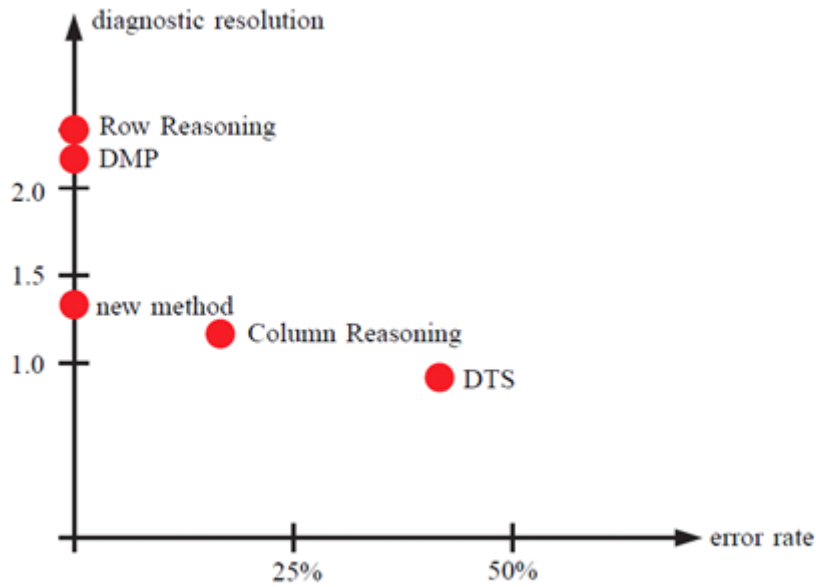

Fig. 6. Comparison of the proposed approach with commonly used approaches in the error rate/diagnostic resolution-plane

5.5 Extension to address multiple faults

In section, some ideas on how the proposed method could be extended to deal with the multiple faults case. As discussed in Koscielny (2003), when dealing with multiple faults two types of situations are considered depending if the faults appear in *simultaneous* or *sequential* way. In order to use the proposed fault isolation approach in case of simultaneous faults (i.e., faults that appear in a time smaller than the waiting time T_w) two cases can be considered:

- in case the fault signals do not present different time of appearance, the fault signature matrices should be extended adding extract columns to consider the case of multiple faults as in the standard FDI approach (see Gertler, 1998). More precisely, a new column for each combination of possible multiple fault to be considered should be added.
- on the other hand, if the fault signals present different time of appearance, the diagnostic inference may fail if two or more faults occur at a time interval that is shorter than the time window T_w needed for diagnosis. So this situation is not supported by the algorithm.

Finally, in case of sequential faults (i.e., faults that appear in a time bigger than the waiting time T_w), the approach can be used under the assumption of single faults, but reconfiguring the fault signature matrices by removing the faulty sensors and the residual expressions where they appear should be derived again. For more details see Figueras *et al.*, (2005).

6. APPLICATION TO THE BARCELONA SEWER NETWORK

6.1 Description

The city of Barcelona, with a population of around 1.593.000 inhabitants living on a surface of 98 Km² approximately, has a combined sewage system of approximately 1697 Km length with a storage capacity of 3.038.622 m³. It is a unitary system that combines waste and rainwater into the same sewers. The yearly rainfall is not very high (600 mm/year), but it includes heavy storms (arriving to 90 mm/h) typical of the Mediterranean climate that can cause a lot of flooding problems and combined sewer overflow (CSO) to the receiving environment. Clavegueram de Barcelona, S.A. (CLABSA) is the company in charge of the sewage system management. Nowadays, for control purposes, the urban drainage system contains 21 pumping stations, 36 gates, 10 valves and 10 detention tanks which are regulated in order to prevent flooding and to CSO the environment. The remote control system is equipped with 56 remote stations including 22 rain-gauges and 136 water-level sensors which provide real-time information (every 5 minutes) about rainfall and water levels into the sewer system. All this information is centralized at the CLABSA Control Centre through a Supervisory Control and Data Acquisition (SCADA) system. The regulated elements (pumps, gates and detention tanks) are currently controlled locally, i.e., they are handled from the remote control centre according to the measurements of sensors connected only to the local station.

6.2 FDI in limnimeters

6.2.1 Introduction

In order to show the proposed FDI methodology in liminimeters, a representative portion of the Barcelona sewer network is studied. The considered portion has a surface of 22,6 Km² and is constituted by 11 catchments. The considered part of the network can be analysed separately from the rest of the network. In this part of the network there are 15 level gauges (limnimeters) and 4 rain-gauges. Using the virtual tank modelling methodology presented in *Section 2.1*, a model for this part of the network is presented in Figure 7 where every catchment is represented by a virtual tank. The structure of the model comes from the network physical topology. The models of each liminimeter ($L_3, L_7, L_8, L_9, L_{16}, L_{19}, L_{27}, L_{39}, L_{41}, L_{45}, L_{54}, L_{56}$ and L_{80}) come from the application of Eq. (5) to the virtual tanks appearing in Figure 7². Figure 8 shows the Boolean fault

² The weirs appearing in Figure 7 in the considered fault scenarios are not overflowing. This is the reason why in the liminimeter models, the overflowing paths have not been considered. If overflowing paths are considered, the structure of the liminimeter models would change. This means that the behaviour of

457 signature matrix (*FSM01*) corresponding to set of residuals that are obtained from the limnimeter models. The other fault
 458 signature matrices (*FSMsign*, *FSMsensit*, *FSMorder* and *FSMtime*) are obtained from the analysis of residual fault sensitivity
 459 (19), as discussed in *Section 5.3*, as described in (Meseguer, 2007;2009). In *Appendix 2*, the content of these matrices is
 460 presented for this application.

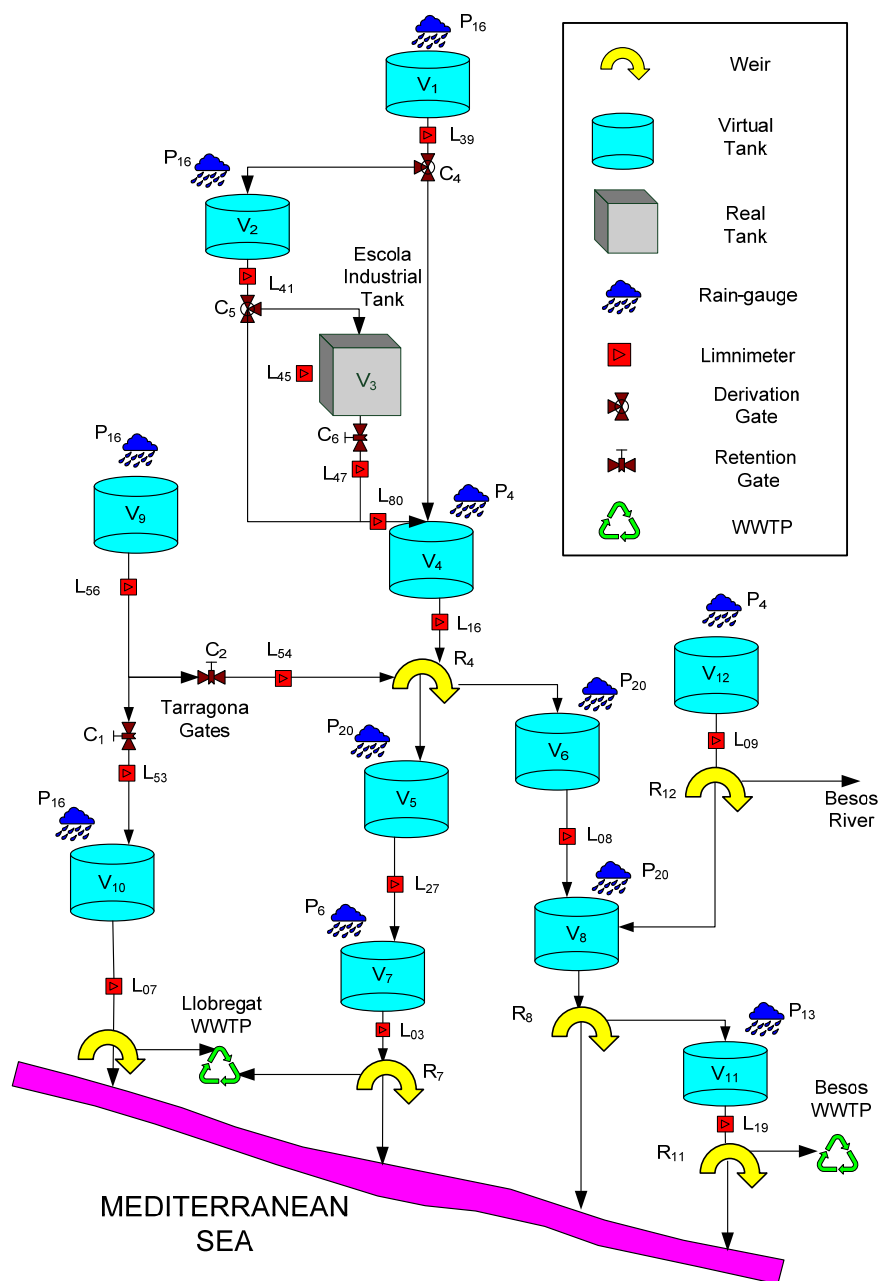

Fig. 7. Virtual reservoir model of the portion of Barcelona network considered

461
 462
 463

the network change according to its state, that is, it is a hybrid system. This would imply extending the proposed approach to hybrid systems. This is currently an on-going work which preliminary results can be found in Vento et al. (2010).

	f _{L3}	f _{L7}	f _{L8}	f _{L9}	f _{L16}	f _{L19}	f _{L27}	f _{L39}	f _{L41}	f _{L45}	f _{L47}	f _{L53}	f _{L54}	f _{L56}	f _{L80}	f _{P4}	f _{P6}	f _{P13}	f _{P16}	f _{P20}
r _{L3}	X						X										X			
r _{L7}		X										X							X	
r _{L8}			X		X															X
r _{L9}				X												X				
r _{L16}					X			X							X	X				
r _{L19}						X												X		
r _{L27}							X													X
r _{L39}								X												X
r _{L41}								X	X											X
r _{L45}									X	X	X									
r _{L54}												X	X	X						
r _{L56}														X						X
r _{L80}											X				X					

465

466

467

Fig. 8. Boolean fault signature matrix of limnimeter: residuals are in rows and faults in columns

468

(“X” represents “1” and a blank a “0”)

469

470 6.2.2 Liminimeter interval model identification

471

472 After the structure of the model for each limnimeter has been obtained, the nominal values and intervals for the parameters are

473 determined using the interval identification method presented in Section 2.3. In order to illustrate how such procedure works,

474 the interval model identification of liminimeter L_{03} is presented. According to Figure 7, the model of this limnimeter has the

475 following structure $L_{03}(k+1) = aL_{03}(k) + bL_{27}(k) + cP_{06}(k)$ according to Eq. (6). Thus, to use the interval identification

476 algorithm, this model should be expressed in regressor form (8). In this case, the regressor is given by

477 $\varphi(k) = [L_{03}(k) \ L_{27}(k) \ P_{06}(k)]$ while the vector of parameters is given by $\theta(k) = [a \ b \ c]^T$. A set of 50 selected real

478 scenarios between 1999 and 2003, free of faults, have been selected for estimating the model parameters and their intervals.

479 The resulting nominal values are $\theta^0 = [0.9014 \ 0.06717 \ 0.1861]^T$ while the intervals are given by

480 $\mathbf{H} = \text{diag}(0.0451, 0.0034, 0.0093)$ according to Eq. (9). Figure 9 shows the interval model prediction using the nominal

481 parameter values and intervals for liminimeter L_{03} for a subset of data used for estimation, while Figure 10 shows the interval

482 model prediction for a subset of data used for validation.

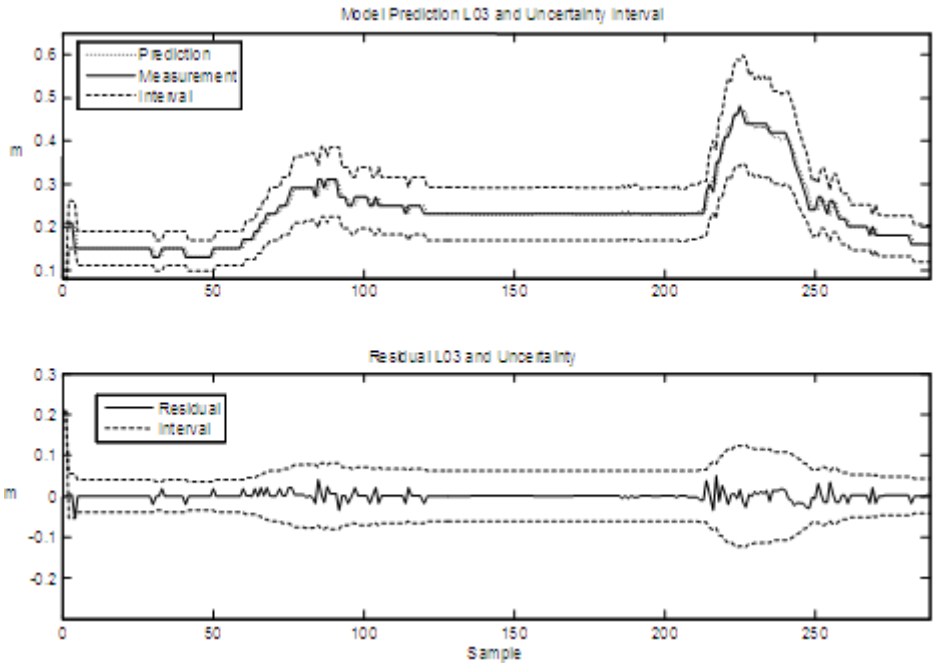

Fig. 9. Estimation of interval model corresponding to limnimeter L_{03}

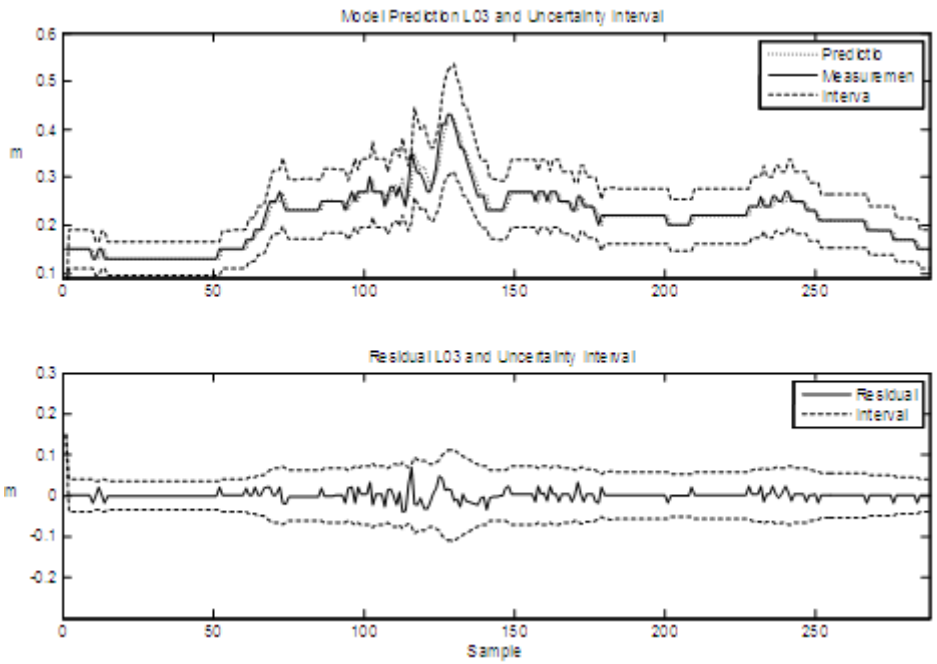

Fig. 10. Validation of interval model corresponding to limnimeter L_{03}

6.2.3 Liminimeter fault scenario

To show how the fault isolation procedure proposed in this paper works in case of liminimeters, a real fault scenario recorded at 14/09/1999 affecting L_{27} is studied. A fault in this sensor appeared at time instant 4000s. Figure 11 presents residuals r_{03}^0

493 and r_{27}^0 , that is, the residuals where L_{27} is involved according to fault signature matrix (see Figure 8). Those residuals are
494 evaluated using the adaptive threshold provided by their interval model. The fault is detected when the limimeter
495 measurement (in continuous line) goes out to the prediction interval (in dash line). Notice that the fault in both residuals is
496 detected at different time instants. Moreover, notice that residual r_{27}^0 is activated only for a short period of time, although the
497 fault is still present. The reason is because detection is based on using parity equations that use model (8) in regressor form.
498 Since the model prediction (8) uses the faulty measurements, after some samples this prediction is contaminated by the fault
499 and the residual come back inside the prediction interval. This phenomenon is known as the *fault following effect* (see Puig,
500 2008 for more details).

501 Figure 12 shows the time evolution of fault isolation factors (***factor01***, ***factor****sign*, ***factor****sensit*, ***factor****order* and ***factor****time*).
502 The fault isolation process starts after the first residual r_{27}^0 is activated at time instant 4000 s (see Figure 11). Using only
503 binary information (***factor01***), the fault candidates would be first L_{27} but later L_{03} , as it can be seen from Figure 12. This is due
504 to the fact that the first the residual r_{27}^0 activates, but later it is deactivated (lack of persistence in the fault signal indication). In
505 particular, when r_{03}^0 , that appears later (at time 7900s), is activated, r_{27}^0 is deactivated. So, residuals r_{03}^0 and r_{27}^0 are never
506 activated at the same time. However, using the information of ***factor****order*, a fault in L_{03} would imply that the first residual
507 activated should be r_{03}^0 instead of r_{27}^0 . So, L_{03} can be already excluded as a fault candidate because is not consistent with the
508 expected order of activation. Later, at time 7900s, the second residual r_{03}^0 is activated confirming that the fault is in L_{27} .
509 Moreover, from the ***factor****time*, the FDI module knows that the fault isolation process is ended and it has not to wait until the
510 end of the time window.

511

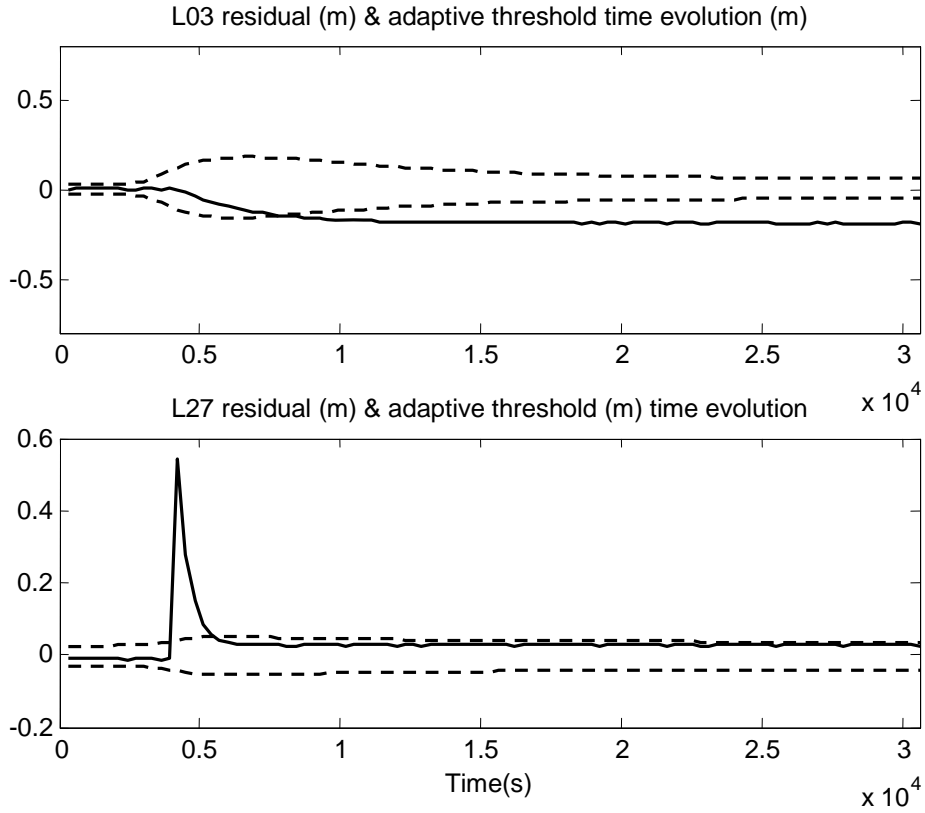

512

513

Fig. 11. Time evolution of the residuals r_{03}^0 and r_{27}^0 with their adaptive thresholds

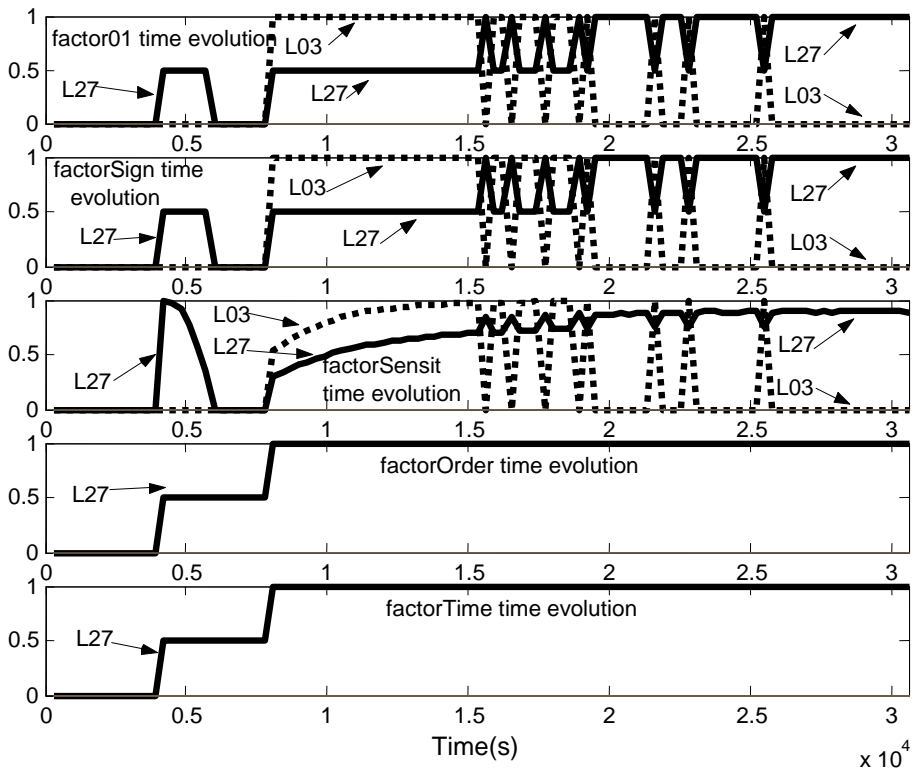

514

515

Fig. 12. Time evolution of factor indicators

516
517
518
519
520
521
522
523
524
525
526
527
528
529
530
531
532
533
534
535
536
537
538
539
540
541
542
543
544
545

6.2.4 Evaluation of the FDI performance

Fault detection performance has been assessed by the evaluation of the minimum detectable fault defined in Section 4.1. The initial and steady state values of the minimum detectable fault for the different residuals are presented in Appendix 3. Since the proposed method stores and works with the maximum value of activated fault signals according to (20), the minimum detectable fault size is given by the maximum value of the residual fault sensitivity (see Eq. (18)).

On the other hand, regarding fault isolation performance, the minimum isolable fault corresponding to each fault can be obtained by finding the maximum of the minimum detectable faults associated to all the residuals that are sensitive to this fault. This fact implies that the minimum isolable fault in case of the proposed approach will be smaller than in the case of the standard FDI approach. The reason is related to the fact that in the proposed approach the minimum detectable fault size is given by the maximum value of the residual fault sensitivity as discussed above. This can be easily seen by looking at the results presented in Appendix 3. Looking for example at output faults (diagonal of the tables in Appendix 3), the smaller size of minimum detectable fault corresponds to the one obtained with the initial fault sensitivity value computed using (18) considering $S_f(q^{-1})|_{q=1}$. On the other hand, using the classic FDI approach (see Gertler, 1998) which reasons continuously with residuals using a column-based reason scheme, since all the residuals sensitive to a fault should be activated to isolate the fault, the minimum isolable fault corresponding to each fault can be obtained by finding the maximum of the minimum steady state detectable faults computed using (18) considering $S_f(q^{-1})|_{q \rightarrow \infty}$. As it can be noticed from the tables in Appendix 3, the values of the initial minimum detectable faults for outputs faults are smaller than the corresponding ones in steady state.

6.3 FDI in rain-gauges

6.3.1 Introduction

The telemetry system of Barcelona sewer network contains 22 rain gauges that are connected to the CLABSA control centre and provide the rain intensity every 5 minutes. Figure 13 presents the location of those rain-gauges on the Barcelona map. Each rain gauge is represented by a small square and a name (black squares correspond to the rain-gauges used in the test catchment presented in Fig. 7, while red squares are the rest of rain-gauges of the sewer network). Spatial models for rain-gauges are derived from the correlation analysis (based on the computation of the correlation matrix) between all the existent rain-gauges in the telemetry system. This allows deriving which are the most correlated rain-gauges with a given rain-gauge

546 under test. These correlation analyses have been applied not only to a particular rain scenario but to a 48 rain scenarios in a 5
 547 year rain-data records. The result of the correlation analysis for the whole set of rain-gauges of the Barcelona sewer network is
 548 presented in the table presented in Figure 14. In this table, for each rain-gauge in rows appear the three most correlated
 549 (derived from the correlation matrix) rain-gauges with the associated explained variance.

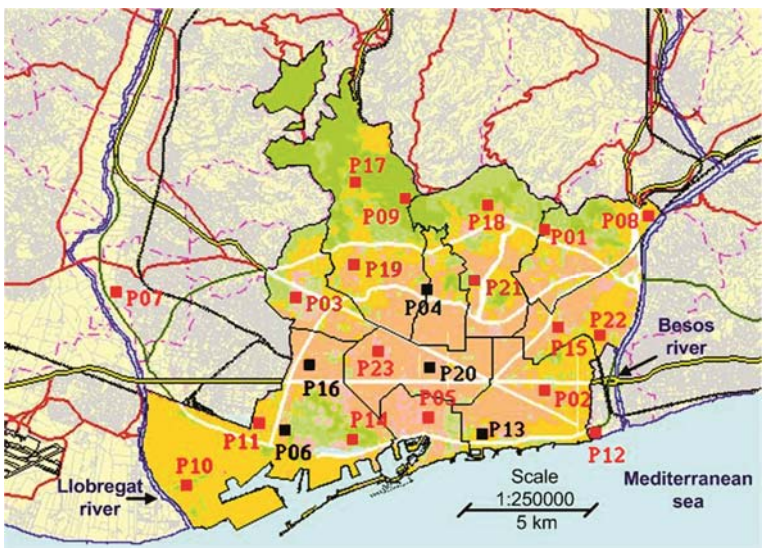

550
 551
 552

Fig. 13. Barcelona's rain-gauge network (rain-gauges are represented with squares)

	1	%	2	%	3	%
P01	18	15.60	21	12.76	8	12.76
P02	15	17.02	12	15.60	13	14.18
P03	19	26.08	16	16.66	17	7.97
P04	21	22.22	20	17.77	19	9.62
P05	20	17.24	14	14.94	13	14.94
P06	11	26.66	14	20.74	10	17.77
P07	3	14.39	10	11.36	19	11.36
P08	1	21.01	15	13.04	22	12.31
P09	17	20.13	19	15.97	18	15.97
P10	11	25.18	6	22.22	14	12.59
P11	6	28.88	10	18.51	14	14.07
P12	2	23.07	13	22.22	15	11.96
P13	2	14.89	12	13.47	5	11.34
P14	6	21.01	16	13.76	11	12.31
P15	2	18.75	22	18.05	21	12.50
P16	3	15.21	6	13.04	19	10.86
P17	9	22.91	19	19.44	3	11.80
P18	1	15.27	21	14.58	9	13.19
P19	3	23.91	17	15.21	4	11.59
P20	4	18.84	5	12.31	13	10.86
P21	4	19.14	15	13.47	18	11.34
P22	15	24.82	2	16.31	21	8.51

553
 554
 555

Fig. 14. Correlation table of the rain-gauges of Barcelona sewer network

556 Once the most correlated rain-gauges have been derived the following question to answer is how many rain-gauge should be
 557 considered in order to build a fault detection model for a given rain-gauge. To answer this question, there is a compromise
 558 between fault detection and fault isolation model properties. An increase in the number of rain-gauges used to model the rain-

559 gauge under test improves the model prediction quality, but decreases the capacity to isolate the faulty rain-gauge due to a
 560 model is affected by the faults of more rain-gauges. In Figueras *et al.* (2005), it has been shown that three rain-gauges,
 561 providing the 70% of data variance, was a good number in this application since provide the best trade-off between model
 562 quality and fault isolation capabilities in case of multiple sequential faults. Figure 15 presents the fault signature matrix in case
 563 that the three most correlated rain-gauges are used to build the models.

564

	f _{P1}	f _{P2}	f _{P3}	f _{P4}	f _{P5}	f _{P6}	f _{P7}	f _{P8}	f _{P9}	f _{P10}	f _{P11}	f _{P12}	f _{P13}	f _{P14}	f _{P15}	f _{P16}	f _{P17}	f _{P18}	f _{P19}	f _{P20}	f _{P21}	f _{P22}
Γ _{P1}	X							X										X			X	
Γ _{P2}		X										X	X		X							
Γ _{P3}			X													X	X		X			
Γ _{P4}				X															X	X	X	
Γ _{P5}					X								X	X						X		
Γ _{P6}						X				X	X			X								
Γ _{P7}			X				X			X									X			
Γ _{P8}	X							X								X						X
Γ _{P9}									X								X	X	X			
Γ _{P10}					X					X	X			X								
Γ _{P11}					X					X	X			X								
Γ _{P12}		X										X	X		X							
Γ _{P13}		X			X							X	X									
Γ _{P14}					X					X				X		X						
Γ _{P15}		X													X						X	X
Γ _{P16}			X			X										X			X			
Γ _{P17}			X						X								X		X			
Γ _{P18}	X								X									X			X	
Γ _{P19}			X	X													X		X			
Γ _{P20}				X	X							X								X		
Γ _{P21}				X											X			X			X	
Γ _{P22}															X						X	X

565

566

567

568

569

570

571

572

573

574

575

Fig. 15. Boolean signature of the rain-gauge residuals (in rows) of Barcelona’s network
 and faults (in columns) (“X” represents “1” and a blank a “0”)

6.3.2 Rain-gauge interval model identification

As in the case of liminimeters, once the structure of the model for each rain-gauge has been derived, the nominal values and intervals for the parameters are determined using the interval identification method presented in Section 2.3. In order to illustrate how such procedure works in this case, the interval model identification of rain-gauge P_{04} is presented. According to Figure 15, the model of this rain-gauge considering the three most correlated ones has the following structure: $P_{04}(k) = \alpha_1 P_{19}(k) + \alpha_2 P_{20}(k) + \alpha_3 P_{21}(k)$ (see Eq. (7)). . Thus, to use the interval identification algorithm, this model should be expressed in regressor form (8) with the regressor given by $\varphi(k) = [P_{19}(k) \ P_{20}(k) \ P_{21}(k)]$ while the vector of

576 parameters is given by $\theta(k) = [\alpha_1 \quad \alpha_2 \quad \alpha_3]^T$. As in the case of liminimeters, a set of 50 scenarios between 1999 and 2003,
 577 free of faults, have been selected for calibrating the model parameters and their intervals. The resulting nominal values are
 578 $\theta^o = [0.1939 \quad 0.3582 \quad 0.4479]^T$ while the intervals are given by $\mathbf{H} = \text{diag}(0.0097, 0.0179, 0.0224)$ according to Eq. (9).
 579 Figure 16 shows the interval model prediction for rain-gauge P_{04} for a subset of data used for estimation, while Figure 17
 580 shows the interval model prediction for a subset of data used for validation.

581

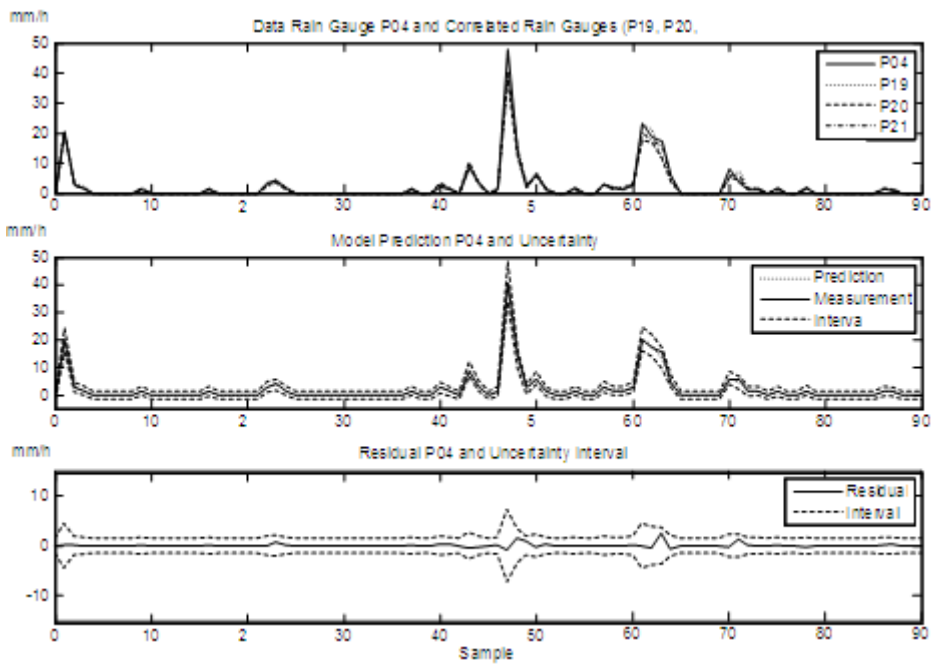

582

583

584

Fig. 16. Estimation of interval model corresponding to limnimeter P_{04}

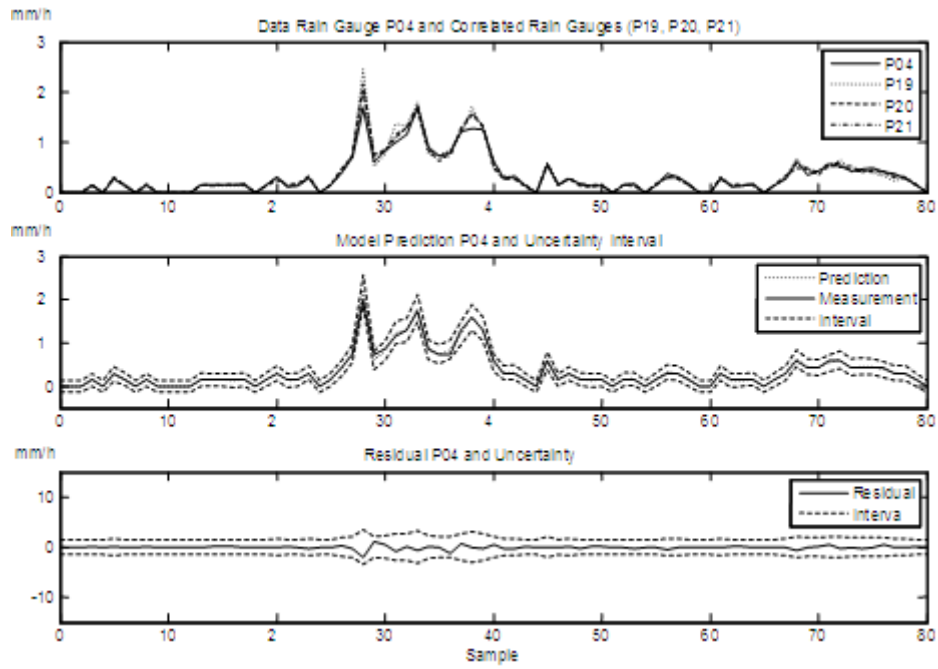

Fig. 17. Validation of interval model corresponding to limnimeter P_{04}

6.3.3 Rain-gauge faulty scenario

To show the effectiveness of the proposed FDI approach in case of rain-gauges, a real fault scenario recorded at 15/11/2001 is considered. In this case, a fault in rain-gauge P_9 was present. This fault was noticed by sewer network operators just by visual inspection comparing this rain gauges with the closest (most correlated) ones. Results from checking real measurements taken from rain-gauge P_9 are compared with their corresponding prediction interval generated using an interval model built from the three most correlated rain-gauges (P_{17} , P_{18} and P_{19}) (see Figure 18). Figure 19 and 20 presents the residuals corresponding to rain-gauges P_{17} and P_{18} where rain-gauge P_9 is also used according to the fault signature matrix in Figure 15. Figure 21 presents the time evolution of *factor_sensit* for the rain-gauges P_9 , P_{17} and P_{18} . It can be noticed that P_9 will be proposed as the candidate faulty rain-gauge according to (21). Since rain-gauge models are static, *factortime* and *factororder* are not used in the rain-gauge fault isolation.

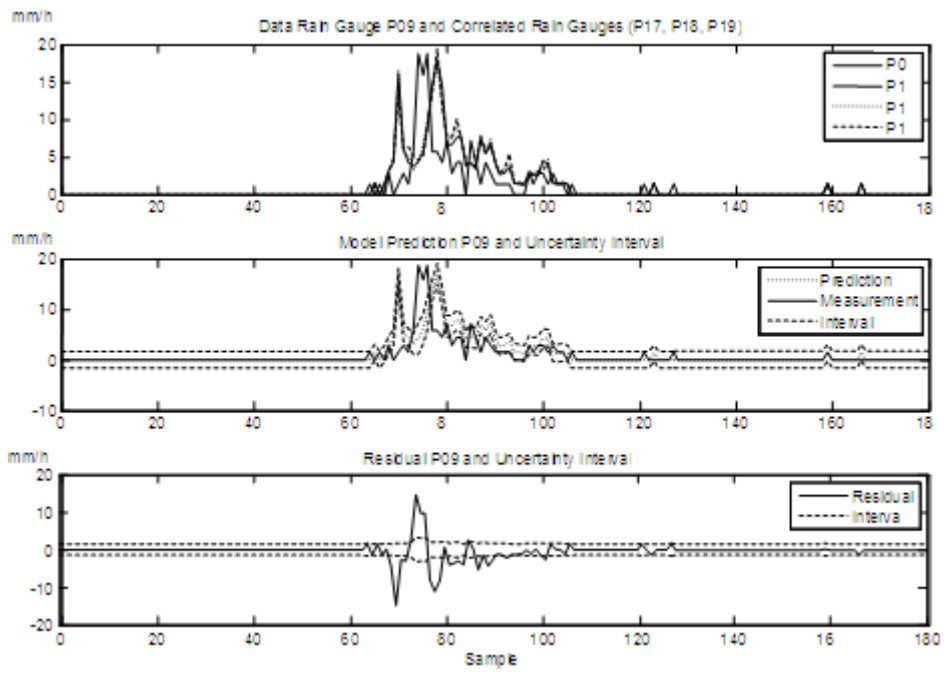

Fig. 18 Fault in rain-gauge P_{09} in the 15/11/2001 rain-scenario

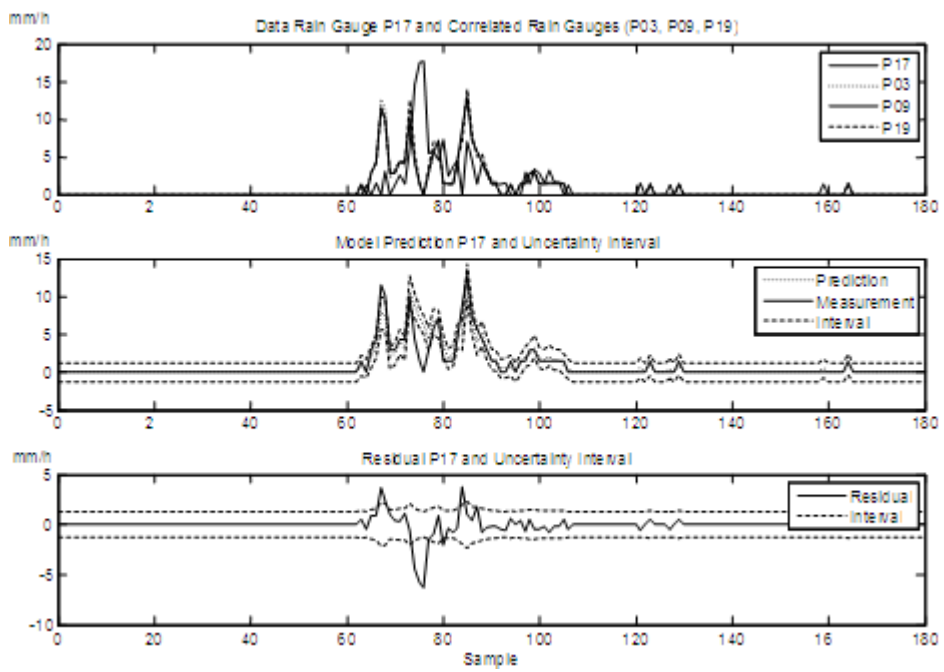

Fig. 19. Fault in rain-gauge P_{09} in the 15/11/2001 rain-scenario

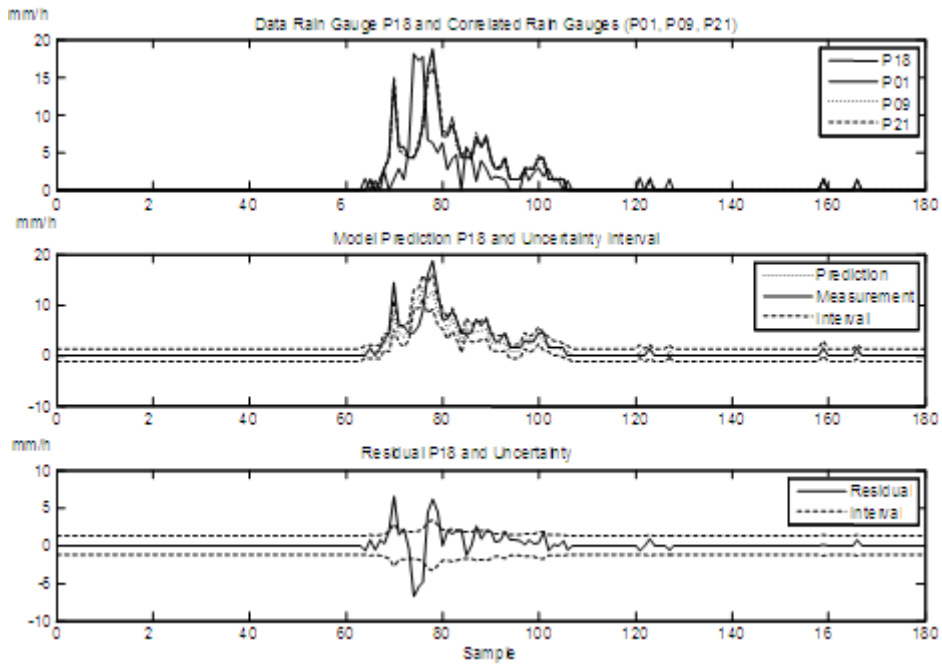

Fig. 20. Fault in rain-gauge P_{09} in the 15/11/2001 rain-scenario

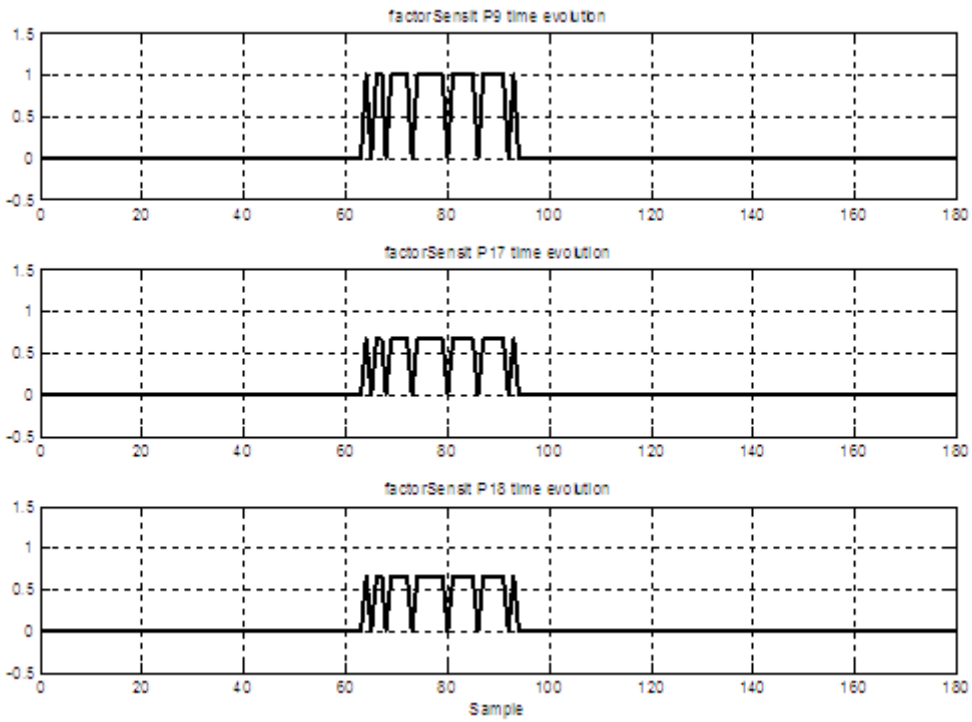

Fig. 21. Time evolution of *factorsensit* indicators

7. CONCLUSIONS

In this paper, fault detection and isolation in rain gauges and limnimeters of Barcelona's urban sewer system is presented. The proposed FDI strategy is based on building a linear interval model for every instrument. Then, each instrument is tested according the prediction provided by its interval model obtained from real data using the parity equation approach. While, the real measurement is inside the interval of predicted behaviour no fault can be indicated. However, when the measurement is outside its envelope a fault can be indicated. Once the fault has been detected, a fault isolation procedure is initiated in order to isolate the faulty instrument. Fault isolation is based on matching of the fault signature with a set of theoretical fault signatures. Finally, the proposed FDI system is applied to several real scenarios providing promising results in order to be applied in real-time operation. As a further work the proposed method will be applied to faults in actuators. Currently, the proposed FDI method is being integrated with MPC control system of the sewer network in order to validate rain-gauges and limnimeters readings. In case that some instrument is in faulty situation, some fault tolerance mechanism should be activated to allow the control system to continue in operation. The design of these fault tolerance mechanisms are also currently under development.

APPENDIX 1

This appendix describes the different fault signatures matrices used for the fault isolation module presented in *Section 5* as well as their usage:

FSM01: Evaluation of fault signal appearance. The *FSM01*-table contains the theoretical binary patterns that faults produce in the residual equations. Those patterns can be codified using the values 0 for no influence, 1 otherwise. *factor01_j* is calculated for the *jth* fault hypothesis in the following way:

$$factor01_j = \frac{\sum_{i=1}^n (boolean(\phi_{i,max}) FSM01_{ij})}{\sum_{i=1}^n FSM01_{ij}} zvf_j \quad (22)$$

with

$$boolean(\phi_{i,max}) = \begin{cases} 0, & \text{if } \phi_{i,max} = 0 \\ 1, & \text{if } \phi_{i,max} \neq 0 \end{cases}$$

and the zero-violation-factor as

$$zvf_j = \begin{cases} 0, & \text{if } \exists i \in \{1, \dots, n\} \text{ with } FSM01_{ij} = 0 \\ & \text{and } \phi_{i, \max} \neq 0 \\ 1, & \text{otherwise} \end{cases}$$

This leads to the following behaviour: expected fault signals support a fault hypothesis, unexpected fault signals are eliminated through the zero-violation-factor. Missing fault signals influence the supportability of a hypothesis indirectly via the denominator of Eq. (22).

FSMsign: Evaluation of fault signal signs. The *FSMsign*-table contains the theoretical sign patterns that faults produce in the residual equations. Those patterns can be codified using the values 0 for no influence, +1/-1 for positive/negative deviation for every *FSMsign_{ij}*.

The *factor_{sign_j}* is calculated comparing theoretical signs to the signs stored in the memory:

$$factor_{sign_j} = \frac{num_{sign_j}}{\sum_{i=1}^n |FSM_{sign_{ij}}|} zvf_{sign_j} \quad (23)$$

where the number of signs in the fault signal vector that coincides with each j^{th} fault hypothesis, considering either the case that all residuals have been violated in the positive or negative patterns in *FSMsign_{ij}* is given by

$$num_{sign_j} = \max\left(\sum_{i=1}^n ckecksign(\phi_{i, \max}, FSM_{sign_{ij}}), \sum_{i=1}^n ckecksign(\phi_{i, \max}, -FSM_{sign_{ij}})\right)$$

with

$$ckecksign(\phi_{i, \max}, FSM_{sign_{ij}}) = \begin{cases} 0 & sign(\phi_{i, \max}) \neq sign(FSM_{sign_{ij}}) \\ 1 & sign(\phi_{i, \max}) = sign(FSM_{sign_{ij}}) \end{cases}$$

where the factor *zvf_{sign_j}* is defined in a similar way as in the case of *factor01*, excluding those fault hypothesis that has a zero in a position where the fault signal presents a sign. The *sign* function is defined as in MATLAB, i.e., $sign(x) = 1$ if $x > 0$, $sign(x) = -1$ if $x < 0$ and $sign(x) = 0$ if $x = 0$.

662 **FSMsensit**: Evaluation of fault sensitivities. This evaluation component uses the fault signal activation values $\phi_{i,\max}$ from the
 663 memory table and computes **factor sensit** using the sensitivity-based **FSMsensit** table for weighting the activation values. That
 664 approach can be found as well in the DMP-method (Petti, *et al.*, 1990). The following equations describe how to calculate the
 665 entries **FSMsensit_{ij}**

666

667

$$\mathbf{FSMsensit}_{ij} = \begin{cases} \frac{S_{ij}}{|\bar{r}_i^o(k)|} & \text{if } r_i^o(k) \geq 0 \\ \frac{S_{ij}}{|r_i^o(k)|} & \text{if } r_i^o(k) < 0 \end{cases} \quad (24)$$

668 with the sensitivity defined as $S_{ij} = \frac{\partial r_i^o}{\partial f_j}$. Although, the sensitivity depends on time in case of a dynamic system, here the
 669 steady-state value after a fault occurrence is considered as it was also suggested in (Gertler, 1998). The value of **FSMsensit_{ij}**
 670 describes, how easily a fault will cause a violation of the threshold of the i^{th} residual since the larger its partial derivative with
 671 respect to the fault, the more sensitive that equation is to deviations of the assumption. Similarly, residuals with large detection
 672 thresholds are less sensitive as they are more difficult to violate. Therefore **FSMsensit_{ij}** can be used to weight the activation
 673 value of different fault signals:

674

675

$$\mathbf{factorsensit}_j = \frac{\sum_{i=1}^n (\phi_{i,\max} \mathbf{FSMsensit}_{ij})}{\sum_{i=1}^n |\mathbf{FSMsensit}_{ij}|} \mathbf{zvfsensit}_{ij} \quad (25)$$

676

677 where the factor **zvfsensit_j** is defined in a similar way as in the case of **factor01**, excluding those fault hypothesis that has a
 678 zero theoretical sensitivity while fault signal presents an non-zero value.

679

680 **FSMorder**: Evaluation of fault signal appearance order. In dynamic systems a fault f_j does not affect at same time all
 681 residuals. **FSMorder** table contains the order of the fault signal apparition for each fault hypothesis; this order is codified
 682 using ordinal numbers, starting with '1'. If two fault signals appear at the same time, then they should share the same ordinal
 683 number. Fault signals that are not associated to an fault hypothesis get the code '0' (Meseguer, 2007;2009). The **factororder** is
 684 calculated comparing the apparition order of the fault signal to the theoretical order stored in the memory. This comparison

685 requires to count the number of apparition order coincidences between the fault signal vector and each j^{th} fault hypothesis
 686 according to:

$$687 \quad \mathbf{factororder}_j = \frac{\sum_{i=1}^n \left(\mathbf{order}(\phi_{i,\max}, \mathbf{FSMorder}_{ij}) \right)}{\sum_{i=1}^n \mathbf{boolean}(\mathbf{FSMorder}_{ij})} \mathbf{zvforder}_{ij} \quad (26)$$

688 where

$$689 \quad \mathbf{order}(\phi_{i,\max}, \mathbf{FSMorder}_{ij}) = \begin{cases} 0 & \mathbf{order}(\phi_{i,\max}) \neq \mathbf{FSMorder}_{ij} \\ 1 & \mathbf{order}(\phi_{i,\max}) = \mathbf{FSMorder}_{ij} \end{cases}$$

690

691 and $\mathbf{order}(\phi_{i,\max})$ is the order of apparition in which the i^{th} fault signal has activated with respect to the first activated. Such
 692 order is recorded in the memory component. The factor $\mathbf{zvforder}_j$ is defined in a similar way as in the case of $\mathbf{factor01}$,
 693 excluding those fault hypothesis that do not coincides in the order .

694

695 **FSMtime: Evaluation of fault signal appearance time.** The element $\mathbf{FSMtime}_{ij}$ of matrix $\mathbf{FSMtime}$ contains the time interval
 696 $[\underline{\tau}_{ij}, \bar{\tau}_{ij}]$ in which the fault signal ϕ caused by fault f_j is expected to appear. This time interval is referred to the occurrence
 697 time instant of the first fault signal according to the fault hypothesis f_j as in most of the cases, the fault occurrence time instant
 698 t_0 is unknown. (Meseguer et al., 2007) shows that the interval $[\underline{\tau}_{ij}, \bar{\tau}_{ij}]$ basically depends on the sensitivity of the residual
 699 $r_i^o(k)$ to fault f_j ($S_{f_{ij}}$), on the adaptive threshold $[\underline{r}_i^o(k), \bar{r}_i^o(k)]$ associated to this residual and on t_0 . Thus, the elements of
 700 matrix $\mathbf{FSMtime}$ are given by

$$701 \quad \mathbf{FSMtime}_{ij} = \begin{cases} [\underline{\tau}_{ij}, \bar{\tau}_{ij}] & \text{if } S_{f_{ij}} \neq 0 \\ [-1, -1] & \text{if } S_{f_{ij}} = 0 \end{cases} \quad (27)$$

702

703 From $\mathbf{FSMtime}$ matrix, the time window T_w which determines the maximum period of time required once the first fault signal
 704 is observed so that all fault signals can appear can be determined as follows

$$705 \quad T_w = \max_{\forall i,j} (\bar{\tau}_{ij}) \quad (28)$$

706 On the other hand, in order to compare the occurrence time instant of the observed fault signal sequence with the stored one in
 707 matrix $\mathbf{FSMtime}$, the factor $\mathbf{factortime}_j$ is calculated for every fault hypothesis as it follows:

708

709

$$\mathbf{factortime}_j(k) = \frac{\sum_{i=1}^{ny} (\text{ckecktime}(k_{\phi_i}, k_{ref}, \mathbf{FSMtime}_{ij}))}{\sum_{i=1}^{ny} \text{boolean}(\mathbf{FSMtime}_{ij})} \mathbf{zvf}_j \quad (29)$$

710

where k_{ϕ_i} is the apparition time instant of the fault signal $\phi_i(k)$, k_{ref} is the apparition time instant of the first observed fault

711

signal,

712

$$\text{ckecktime}(k_{\phi_i}, k_{ref}, \mathbf{FSMtime}_{ij}) = \begin{cases} 0 & \text{if } k_{\phi_i} - k_{ref} \notin \mathbf{FSMtime}_{ij} \text{ or } |\phi_i(k)| < 0.5 \\ 1 & \text{if } k_{\phi_i} - k_{ref} \in \mathbf{FSMtime}_{ij} \text{ and } |\phi_i(k)| \geq 0.5 \end{cases} \quad (30)$$

713

714

$$\text{boolean}(\mathbf{FSMtime}_{ij}) = \begin{cases} 0, & \text{if } \mathbf{FSMtime}_{ij} = [-1, -1] \\ 1, & \text{if } \mathbf{FSMtime}_{ij} \neq [-1, -1] \end{cases} \quad (31)$$

715

and where \mathbf{zvf}_j is the zero-violation-factor whose expression is

716

$$\mathbf{zvf}_j = \begin{cases} 0, & \text{if } \exists i \in \{1, \dots, n\} \text{ with } \mathbf{FSM01}_{ij} = 0 \\ & \text{and } |\phi_i(k)| \geq 0.5 \\ 1, & \text{otherwise} \end{cases} \quad (32)$$

717

718

719

APPENDIX 2

720

This appendix presents the contents of the different fault signatures matrices used for the fault isolation module of limnimeters

721

in the Barcelona sewer network case study.

722

723

FSM01 Matrix

	f_{L3}	f_{L7}	f_{L8}	f_{L9}	f_{L16}	f_{L19}	f_{L27}	f_{L39}	f_{L41}	f_{L45}	f_{L47}	f_{L53}	f_{L54}	f_{L56}	f_{L80}
ϕ_{L3}	1	0	0	0	0	0	1	0	0	0	0	0	0	0	0
ϕ_{L7}	0	1	0	0	0	0	0	0	0	0	0	1	0	0	0
ϕ_{L8}	0	0	1	0	1	0	0	0	0	0	0	0	0	0	0
ϕ_{L9}	0	0	0	1	0	0	0	0	0	0	0	0	0	0	0
ϕ_{L16}	0	0	0	0	1	0	0	0	0	0	0	0	0	0	1
ϕ_{L19}	0	0	0	0	0	1	0	0	0	0	0	0	0	0	0
ϕ_{L27}	0	0	0	0	0	0	1	0	0	0	0	0	0	0	0
ϕ_{L39}	0	0	0	0	0	0	0	1	0	0	0	0	0	0	0
ϕ_{L41}	0	0	0	0	0	0	0	1	1	0	0	0	0	0	0
ϕ_{L45}	0	0	0	0	0	0	0	0	1	1	1	0	0	0	0
ϕ_{L54}	0	0	0	0	0	0	0	0	0	0	0	1	1	1	0
ϕ_{L56}	0	0	0	0	0	0	0	0	0	0	0	0	0	1	0
ϕ_{L80}	0	0	0	0	0	0	0	0	0	0	1	0	0	0	1

724

725

FSM sign Matrix

	f_{L3}	f_{L7}	f_{L8}	f_{L9}	f_{L16}	f_{L19}	f_{L27}	f_{L39}	f_{L41}	f_{L45}	f_{L47}	f_{L53}	f_{L54}	f_{L56}	f_{L80}
ϕ_{L3}	+1	0	0	0	0	0	-1	0	0	0	0	0	0	0	0
ϕ_{L7}	0	+1	0	0	0	0	0	0	0	0	0	-1	0	0	0
ϕ_{L8}	0	0	+1	0	-1	0	0	0	0	0	0	0	0	0	0
ϕ_{L9}	0	0	0	+1	0	0	0	0	0	0	0	0	0	0	0
ϕ_{L16}	0	0	0	0	+1	0	0	0	0	0	0	0	0	0	-1
ϕ_{L19}	0	0	0	0	0	+1	0	0	0	0	0	0	0	0	0

ϕ_{L27}	0	0	0	0	0	0	0	+1	0	0	0	0	0	0	0	0	0
ϕ_{L39}	0	0	0	0	0	0	0	0	+1	0	0	0	0	0	0	0	0
ϕ_{L41}	0	0	0	0	0	0	0	0	-1	+1	0	0	0	0	0	0	0
ϕ_{L45}	0	0	0	0	0	0	0	0	0	-1	+1	-1	0	0	0	0	0
ϕ_{L54}	0	0	0	0	0	0	0	0	0	0	0	0	-1	+1	-1	0	0
ϕ_{L56}	0	0	0	0	0	0	0	0	0	0	0	0	0	0	0	+1	0
ϕ_{L80}	0	0	0	0	0	0	0	0	0	0	0	-1	0	0	0	0	+1

726
727
728

FSM sensit Matrix

	f_{L3}	f_{L7}	f_{L8}	f_{L9}	f_{L16}	f_{L19}	f_{L27}	f_{L39}	f_{L41}	f_{L45}	f_{L47}	f_{L53}	f_{L54}	f_{L56}	f_{L80}		
ϕ_{L3}	0.241	0	0	0	0	0	-0.156	0	0	0	0	0	0	0	0	0	0
ϕ_{L7}	0	0.115	0	0	0	0	0	0	0	0	0	-0.033	0	0	0	0	0
ϕ_{L8}	0	0	0.360	0	-0.193	0	0	0	0	0	0	0	0	0	0	0	0
ϕ_{L9}	0	0	0	0.128	0	0	0	0	0	0	0	0	0	0	0	0	0
ϕ_{L16}	0	0	0	0	0.383	0	0	0	0	0	0	0	0	0	0	0	-1
ϕ_{L19}	0	0	0	0	0	0.033	0	0	0	0	0	0	0	0	0	0	0
ϕ_{L27}	0	0	0	0	0	0	0.082	0	0	0	0	0	0	0	0	0	0
ϕ_{L39}	0	0	0	0	0	0	0	0.379	0	0	0	0	0	0	0	0	0
ϕ_{L41}	0	0	0	0	0	0	0	-0.958	0.042	0	0	0	0	0	0	0	0
ϕ_{L45}	0	0	0	0	0	0	0	0	-0.254	0.014	0.187	0	0	0	0	0	0
ϕ_{L54}	0	0	0	0	0	0	0	0	0	0	0	0	-0.810	1	-0.393	0	0
ϕ_{L56}	0	0	0	0	0	0	0	0	0	0	0	0	0	0	0	0.080	0
ϕ_{L80}	0	0	0	0	0	0	0	0	0	0	-0.580	0	0	0	0	0	0.256

729
730

FSM order Matrix

	f_{L3}	f_{L7}	f_{L8}	f_{L9}	f_{L16}	f_{L19}	f_{L27}	f_{L39}	f_{L41}	f_{L45}	f_{L47}	f_{L53}	f_{L54}	f_{L56}	f_{L80}		
ϕ_{L3}	1	0	0	0	0	0	2	0	0	0	0	0	0	0	0	0	0
ϕ_{L7}	0	1	0	0	0	0	0	0	0	0	0	2	0	0	0	0	0
ϕ_{L8}	0	0	1	0	2	0	0	0	0	0	0	0	0	0	0	0	0
ϕ_{L9}	0	0	0	1	0	0	0	0	0	0	0	0	0	0	0	0	0
ϕ_{L16}	0	0	0	0	1	0	0	0	0	0	0	0	0	0	0	2	0
ϕ_{L19}	0	0	0	0	0	1	0	0	0	0	0	0	0	0	0	0	0
ϕ_{L27}	0	0	0	0	0	0	1	0	0	0	0	0	0	0	0	0	0
ϕ_{L39}	0	0	0	0	0	0	0	1	0	0	0	0	0	0	0	0	0
ϕ_{L41}	0	0	0	0	0	0	0	2	1	0	0	0	0	0	0	0	0
ϕ_{L45}	0	0	0	0	0	0	0	0	2	1	2	0	0	0	0	0	0
ϕ_{L54}	0	0	0	0	0	0	0	0	0	0	0	1	1	1	1	0	0
ϕ_{L56}	0	0	0	0	0	0	0	0	0	0	0	0	0	0	1	0	0
ϕ_{L80}	0	0	0	0	0	0	0	0	0	0	1	0	0	0	0	0	1

731
732

FSMtime Matrix

	f_{L3}	f_{L7}	f_{L8}	f_{L9}	f_{L16}	f_{L19}	f_{L27}	f_{L39}	f_{L41}	f_{L45}	f_{L47}	f_{L53}	f_{L54}	f_{L56}	f_{L80}		
ϕ_{L3}	[0,0]	[-1,-1]	[-1,-1]	[-1,-1]	[-1,-1]	[-1,-1]	[900,6300]	[-1,-1]	[-1,-1]	[-1,-1]	[-1,-1]	[-1,-1]	[-1,-1]	[-1,-1]	[-1,-1]	[-1,-1]	[-1,-1]
ϕ_{L7}	[-1,-1]	[0,0]	[-1,-1]	[-1,-1]	[-1,-1]	[-1,-1]	[-1,-1]	[-1,-1]	[-1,-1]	[-1,-1]	[-1,-1]	[2100,5400]	[-1,-1]	[-1,-1]	[-1,-1]	[-1,-1]	[-1,-1]
ϕ_{L8}	[-1,-1]	[-1,-1]	[0,0]	[-1,-1]	[600,4200]	[-1,-1]	[-1,-1]	[-1,-1]	[-1,-1]	[-1,-1]	[-1,-1]	[-1,-1]	[-1,-1]	[-1,-1]	[-1,-1]	[-1,-1]	[-1,-1]
ϕ_{L9}	[-1,-1]	[-1,-1]	[-1,-1]	[0,0]	[-1,-1]	[-1,-1]	[-1,-1]	[-1,-1]	[-1,-1]	[-1,-1]	[-1,-1]	[-1,-1]	[-1,-1]	[-1,-1]	[-1,-1]	[-1,-1]	[-1,-1]
ϕ_{L16}	[-1,-1]	[-1,-1]	[-1,-1]	[-1,-1]	[0,0]	[-1,-1]	[-1,-1]	[-1,-1]	[-1,-1]	[-1,-1]	[-1,-1]	[-1,-1]	[-1,-1]	[-1,-1]	[-1,-1]	[-1,-1]	[300,2400]
ϕ_{L19}	[-1,-1]	[-1,-1]	[-1,-1]	[-1,-1]	[-1,-1]	[0,0]	[-1,-1]	[-1,-1]	[-1,-1]	[-1,-1]	[-1,-1]	[-1,-1]	[-1,-1]	[-1,-1]	[-1,-1]	[-1,-1]	[-1,-1]
ϕ_{L27}	[-1,-1]	[-1,-1]	[-1,-1]	[-1,-1]	[-1,-1]	[-1,-1]	[0,0]	[-1,-1]	[-1,-1]	[-1,-1]	[-1,-1]	[-1,-1]	[-1,-1]	[-1,-1]	[-1,-1]	[-1,-1]	[-1,-1]
ϕ_{L39}	[-1,-1]	[-1,-1]	[-1,-1]	[-1,-1]	[-1,-1]	[-1,-1]	[-1,-1]	[0,0]	[-1,-1]	[-1,-1]	[-1,-1]	[-1,-1]	[-1,-1]	[-1,-1]	[-1,-1]	[-1,-1]	[-1,-1]
ϕ_{L41}	[-1,-1]	[-1,-1]	[-1,-1]	[-1,-1]	[-1,-1]	[-1,-1]	[-1,-1]	[300,3900]	[0,0]	[-1,-1]	[-1,-1]	[-1,-1]	[-1,-1]	[-1,-1]	[-1,-1]	[-1,-1]	[-1,-1]
ϕ_{L45}	[-1,-1]	[-1,-1]	[-1,-1]	[-1,-1]	[-1,-1]	[-1,-1]	[-1,-1]	[-1,-1]	[300,1800]	[0,0]	[300,30600]	[-1,-1]	[-1,-1]	[-1,-1]	[-1,-1]	[-1,-1]	[-1,-1]
ϕ_{L54}	[-1,-1]	[-1,-1]	[-1,-1]	[-1,-1]	[-1,-1]	[-1,-1]	[-1,-1]	[-1,-1]	[-1,-1]	[-1,-1]	[-1,-1]	[0,0]	[0,0]	[0,0]	[-1,-1]	[-1,-1]	[-1,-1]
ϕ_{L56}	[-1,-1]	[-1,-1]	[-1,-1]	[-1,-1]	[-1,-1]	[-1,-1]	[0,0]	[-1,-1]	[-1,-1]	[-1,-1]	[-1,-1]	[-1,-1]	[-1,-1]	[0,0]	[0,0]	[-1,-1]	[-1,-1]
ϕ_{L80}	[-1,-1]	[-1,-1]	[-1,-1]	[-1,-1]	[-1,-1]	[-1,-1]	[0,0]	[-1,-1]	[-1,-1]	[-1,-1]	[-1,-1]	[0,0]	[-1,-1]	[-1,-1]	[-1,-1]	[-1,-1]	[0,0]

733
734

735 This appendix presents the averages values of the minimum initial and steady state detectable faults. The intervals correspond
 736 to the evaluation of Eq (18) with $\min(\|\varphi(k)\mathbf{H}\|_1)$ and $\max(\|\varphi(k)\mathbf{H}\|_1)$.

737
 738
 739
 740
 741
 742

Initial minimum detectable faults

$|f_f^{\min}|$ with $S_f(q^{-1})|_{q \rightarrow \infty}$

	f_{L3}	f_{L7}	f_{L8}	f_{L9}	f_{L16}	f_{L19}	f_{L27}	f_{L39}	f_{L41}	f_{L45}	f_{L47}	f_{L53}	f_{L54}	f_{L56}	f_{L80}
R_{L3}	[0.1,0.22]	∞	∞	∞	∞	∞	[0.45,1]	∞	∞	∞	∞	∞	∞	∞	∞
R_{L7}	∞	[0.06,0.1]	∞	∞	∞	∞	∞	∞	∞	∞	∞	[0.3,0.5]	∞	∞	∞
R_{L8}	∞	∞	[0.1,0.15]	∞	[0.4,0.6]	∞	∞	∞	∞	∞	∞	∞	∞	∞	∞
R_{L9}	∞	∞	∞	[0.1,0.43]	∞	∞	∞	∞	∞	∞	∞	∞	∞	∞	∞
R_{L16}	∞	∞	∞	∞	[0.1,0.35]	∞	∞	∞	∞	∞	∞	∞	∞	∞	[0.28,1]
R_{L19}	∞	∞	∞	∞	∞	[0.1,0.13]	∞	∞	∞	∞	∞	∞	∞	∞	∞
R_{L27}	∞	∞	∞	∞	∞	∞	[0.1,0.27]	∞	∞	∞	∞	∞	∞	∞	∞
R_{L39}	∞	∞	∞	∞	∞	∞	∞	[0.1,0.57]	∞	∞	∞	∞	∞	∞	∞
R_{L41}	∞	∞	∞	∞	∞	∞	∞	[0.4,1.2]	[0.1,0.32]	∞	∞	∞	∞	∞	∞
R_{L45}	∞	∞	∞	∞	∞	∞	∞	∞	[0.07,0.7]	[0.1,0.92]	[0.11,0.97]	∞	∞	∞	∞
R_{L54}	∞	∞	∞	∞	∞	∞	∞	∞	∞	∞	∞	[0.35,0.55]	[0.1,0.16]	[0.42,0.67]	∞
R_{L56}	∞	∞	∞	∞	∞	∞	∞	∞	∞	∞	∞	∞	∞	[0.1,0.39]	∞
R_{L80}	∞	∞	∞	∞	∞	∞	∞	∞	∞	∞	∞	[0.13,0.46]	∞	∞	[0.1,0.36]

743
 744
 745

Steady state minimum detectable faults

$|f_f^{\min}|$ with $S_f(q^{-1})|_{q=1}$

	f_{L3}	f_{L7}	f_{L8}	f_{L9}	f_{L16}	f_{L19}	f_{L27}	f_{L39}	f_{L41}	f_{L45}	f_{L47}	f_{L53}	f_{L54}	f_{L56}	f_{L80}
R_{L3}	[0.4,0.91]	∞	∞	∞	∞	∞	[0.45,1]	∞	∞	∞	∞	∞	∞	∞	∞
R_{L7}	∞	[0.31,0.5]	∞	∞	∞	∞	∞	∞	∞	∞	∞	[0.3,0.5]	∞	∞	∞
R_{L8}	∞	∞	[0.3,0.45]	∞	[0.41,0.6]	∞	∞	∞	∞	∞	∞	∞	∞	∞	∞
R_{L9}	∞	∞	∞	[0.67,2.9]	∞	∞	∞	∞	∞	∞	∞	∞	∞	∞	∞
R_{L16}	∞	∞	∞	∞	[0.3,1]	∞	∞	∞	∞	∞	∞	∞	∞	∞	[0.28,1]
R_{L19}	∞	∞	∞	∞	∞	[3,30]	∞	∞	∞	∞	∞	∞	∞	∞	∞
R_{L27}	∞	∞	∞	∞	∞	∞	[0.8,2]	∞	∞	∞	∞	∞	∞	∞	∞
R_{L39}	∞	∞	∞	∞	∞	∞	∞	[0.4,2.3]	∞	∞	∞	∞	∞	∞	∞
R_{L41}	∞	∞	∞	∞	∞	∞	∞	[0.4,1.2]	[0.6,2.1]	∞	∞	∞	∞	∞	∞
R_{L45}	∞	∞	∞	∞	∞	∞	∞	∞	[0.07,0.7]	[1.1,9.2]	[0.11,0.97]	∞	∞	∞	∞
R_{L54}	∞	∞	∞	∞	∞	∞	∞	∞	∞	∞	∞	[0.35,0.55]	[0.45,0.73]	[0.42,0.67]	∞
R_{L56}	∞	∞	∞	∞	∞	∞	∞	∞	∞	∞	∞	∞	∞	[2,7.8]	∞
R_{L80}	∞	∞	∞	∞	∞	∞	∞	∞	∞	∞	∞	[0.13,0.46]	∞	∞	[0.45,1.64]

746
 747
 748
 749

ACKNOWLEDGMENTS

750 The authors want to thank to all the members of SAC group actively involved in this research line as Joseba Quevedo, Jaume Figueras,
 751 Teresa Escobet, Belarmino Pulido and Jordi Meseguer. Without their help, this research has not gone so far. The authors want also to thank
 752 the people of CLABSA company that during the same period has cooperated actively to do this research possible: Joaquim Martí, Maria
 753 Salamero, Gustavo Ramon Wilhelmi, Blanca Aznar and Jordi Cabot.

754
755
756
757
758
759
760
761
762
763
764
765
766
767
768
769
770
771
772
773
774
775
776
777
778
779
780
781
782
783
784

REFERENCES

- Basseville, M., Nikiforov, I. “Detection of Abrupt Changes: Theory and Applications”. Prentice Hall. 2003.
- J. Blesa, V. Puig, J. Saludes. Identification for passive robust fault detection using zonotope-based set-membership approaches. *International Journal of Adaptive Control and Signal Processing*. 25 (9) 788–812. 2011.
- Boukhris, A., Giuliani, S., Mourot, G. “Rainfall-runoff modeling for sensor diagnosis”. In Proc. IFAC SAFEPROCESS’97, Hull, England. 1997.
- Boukhris, A., Giuliani, S., Mourot, G, “Rainfall-runoff multi-modelling for sensor fault diagnosis”, *Control Engineering Practice*, vol 9 (6), pp. 659-671. 2001
- Calafiore, G., Campi, M.C. and L. El Ghaoui. “Identification of Reliable Predictor Models for Unknown Systems: a Data-Consistency Approach based on Learning Theory”. IFAC World Congress, Barcelona, Spain, 2002.
- Campi, M.C., Calafiore, G., Garatti, S. “Interval predictor models: Identification and reliability”, *Automatica*, Volume 45, Issue 8. pp. 382-392. 2009.
- Cembrano, G., Quevedo, J., Salamero, M., Puig, V., Figueras, J. and Martí, J. Optimal control of urban drainage systems: a case study. *Control Engineering Practice*, 12(1), pp. 1-9, 2004.
- Combastel, C., S. Gentil, and J. P. Rognon.. “Toward a better integration of residual generation and diagnostic decision”. IFAC SAFEPROCESS’03, Washington, USA. 2003.
- Cordier, M., P. Dague, F. Lévy, J. Montmain, M. Staroswiecki, and L. Travé-Massuyès, “Conflicts versus analytical redundancy relations: a comparative analysis of the model-based diagnosis approach from the artificial intelligence and automatic control perspectives”. *IEEE Transactions on Systems, Man, and Cybernetics. Part B: Cybernetics*. vol. 34, no. 5, pp. 2163–2177, 2004.
- Chen J. and R.J. Patton. “Robust Model-Based Fault Diagnosis for Dynamic Systems”. Kluwer Academic Publishers. 1999.
- Duchesne, S., Mailhot, A., Dequidt, E., and Villeneuve, J.. Mathematical modeling of sewers under surcharge for real time control of combined sewer overflows. *Urban Water*, 3:241-252, 2001.
- Figueras, J., Cembrano, G., Puig, V., Quevedo, J., Salamero, M. and Martí, J. CORAL: an object-oriented tool for optimal control of sewer networks. *Proceedings on IEEE International Symposium on computer aided control system design*, pp. 224–229, 2002.
- Figueras, J., Puig, V., Quevedo, J. Fault Diagnosis under Multiple Sequential Faults of the Rain-Gauge Network used to Control the Barcelona Sewer System. *Proceedings of the 16th World Congress IFAC*. Prague, Czech Republic. 2005.
- Gelormino, M. and Ricker, N. Model predictive control of a combined sewer system. *International Journal of Control*, 59, pp. 793-816, 1994.
- Gertler J.J. “Fault Detection and Diagnosis in Engineering Systems”. Marcel Dekker, 1998.

785 Guerra, P., Puig, V. "Passive Robust Fault Detection using Interval MA Parity Equations: Inverse vs Direct Image Tests".
786 Proceedings of the 17th World Congress IFAC. Seoul, Korea. 2008.

787 Giuliani, S., Boukhris, A., Mourot, G. "Principles of a Rain Gauge Fault Diagnosis System for Urban Sewer Network Control". In
788 Proc. IFAC SAFEPROCESS 1997, Hull, England, 1997.

789 Kóscielny, J. M. "Fault isolation in industrial processes by the dynamic table of states method," *Automatica*, vol. 31, pp. 747–753,
790 1995.

791 Kóscielny, J.M., Bartys, M. "Multiple Fault Isolation in Diagnostics of Industrial Processes". European Control Conference (ECC03).
792 Cambridge, UK.

793 Marinaki, M. and Papageorgiou, M. *Optimal Real-time Control of Sewer Networks*. Springer. 2005.

794 Maciejowski, J.M. "Predictive Methods in Fault-tolerant Control" in *Control of Complex Systems* by Aström, K.J et al. (Eds).
795 Springer. 2001.

796 Ragot, J., Maquin, D. (2006). "Fault measurement detection in an urban water supply network". *Journal of Process Control*, Volume
797 16, Issue 9, Pages 887-902, 2006.

798 Meseguer, J., Puig, V., Escobet, T., Quevedo, J. "Sensor Fault Diagnosis using Linear Interval Observers" Workshop on Principles of
799 Diagnosis DX'07. Nashville, TN, USA. 2007.

800 Meseguer, J., Puig, V., Escobet, T. "Fault Diagnosis Using a Timed Discrete-Event Approach Based on Interval Observers:
801 Application to Sewer Networks". *IEEE Transactions on Systems, Man and Cybernetics: Part A*, Volume 40(5), pp. 900-916.

802 Milanese, M., Norton, J., Piet-Lahanier, H., Walter, E. (eds). "Bounding Approaches to System Identification". Plenum Press.H.
803 1996.

804 Nikiforov, I. "A simple recursive algorithm for diagnosis of abrupt changes in signals and systems". *Proceedings of the 1998*
805 *American Control Conference*, vol.3.

806 Ocampo-Martínez, C., Ingimundarson, A., Puig, V. and Quevedo, J. Objective prioritization using lexicographic minimizers for
807 MPC of sewer networks. *IEEE Transactions on Control Systems Technology*, 16(1):113-121, 2008.

808 Patton, R.J., Frank, P.M. and R.N. Clark. "Issues of fault diagnosis for dynamics systems". Springer. 2000.

809 Pleau, M., Colas, H., Lavallo, P., Pelletier, G., and Bonin, R. Global optimal real-time control of the Quebec urban drainage system.
810 *Environmental Modelling & Software*, 20:401-413, 2005.

811 Petti, T.F., J. Klein, and P. S. Dhurjati. "Diagnostic model processor: Using deep knowledge for process fault diagnosis," *AICHE*
812 *Journal*, vol. 36, p. 565. 1990.

813 Piatyszek, E., Voignier, P. and Graillot, D. (2000). Fault detection on a sewer network by a combination of a Kalman filter and a
814 binary sequential probability ratio test. *Journal of Hydrology*, Volume 230, Issues 3-4, Pages 258-268, 2000.

815 Ploix, S., Adrot, O. and J. Ragot. "Parameter Uncertainty Computation in Static Linear Models". 38th IEEE Conference on Decision
816 and Control. Phoenix. Arizona. USA. 1999.

817 Puig, V., Quevedo, J., Escobet, T. Nejjari, F., S. de las Heras. "Passive Robust Fault Detection of Dynamic Processes Using Interval
818 Models", IEEE Transactions on Control Systems Technology, Volume 16, Issue 5, 1083 – 1089, Sept. 2008.

819 Puig, V. J. Quevedo, T. Escobet, and B. Pulido. "A New Fault Diagnosis Algorithm that Improves the Integration of Fault Detection
820 and Isolation" in Proceedings of ECC-CDC'05, Sevilla, Spain. 2005.

821 Schilling, W., Anderson, B., Nyberg, U., Aspegren, H., Rauch, W., and Harremes, P.. Real-time control of wastewater systems.
822 Journal of Hydraulic Resources, 34(6):785-797, 1996.

823 Schütze, M., Campisano, A., Colas, H., Schilling, W. and Vanrolleghe, P. Real time control of urban wastewater systems: Where do
824 we stand today? Journal of Hydrology, 299:335-348, 2004.

825 Schütze, M., Butler, D. and Beck, B. Modelling, Simulation and Control of Urban Wastewater Systems. Springer. 2002.

826 Vanden Daele, R. Y. Peng and M. Kinnaert "Fault diagnosis using belief functions" in Proceedings of SAFEPROCESS'97, Hull,
827 U.K., pp 546-551, 1997.

828 Vento, J.; Puig, V.; Sarrate, R. (2010). "Fault Detection and Isolation of Hybrid Systems using Diagnosers that combine Discrete and
829 Continuous Dynamics". Conference on Control and Fault Tolerant Systems, Nice, France