

Parametric Design of Stop Band Pass Filter Based on RF Metamaterials in LTCC Technology

M. Morata¹, I. Gil², and R. Fernández-García²

¹Escuela Universitaria Salesiana de Sarriá, Barcelona 08017, Spain

²Departament of Electronic Engineering, Universitat Politècnica de Catalunya, Terrassa 08222, Spain

Abstract— This paper presents a novel approach to design a parametric RF stop band pass filter based on Low Temperature Co-fired Ceramic (LTCC) Technology. The LTCC technology enables to miniaturize and development compact structures using not only the standard xy -planar circuit dimensions but also the z -height dimension. The proposed filters topologies are based on a stripline loaded with one or several complementary rings resonator (CSRRs). Specifically, a parametric study z -location of the stripline respect to the CSRRs is carried out in order to determine the optimum configurations operating in the Ku-band.

1. INTRODUCTION

Efficient filtering microwave techniques are crucial in order to design microwave circuit applications in many areas such as signal processing, wireless communications, military uses or biomedical engineering. Specifically, several works have been developed in order to design new microwave Ku-band filters [1]. Recently, metamaterial transmission lines (TLs) (i.e., artificial lines consisting of a host line loaded with reactive elements) have been used to develop microwave filters in printed circuit board (PCB) [2]. Alternatively, complementary split ring resonators (CSRRs) have been revealed as good candidates in order to improve the performance of conventional microwave filters [3]. On the other hand, the Low Temperature Co-fired Ceramic (LTCC) technology (Fig. 1) has become an alternative platform for implementing RF passive components and circuits due to its high performance, reliability and low losses [4]. Therefore, LTCC technology enables further miniaturization and development of compact structures using not only the standard xy -planar circuit dimension but also the z -height dimension [5].

The aim of this work is to develop a parametric design of several RF metamaterial stop-band filters based on a stripline loaded with complementary split ring resonators (CSRRs) in LTCC technology in order to show an alternative way to implement stop band pass filter based on RF metamaterials. The analysis of the influence of the different parameters such as the relative xyz -location of CSRRs with regard to the host transmission line has been performed in terms of frequency response. Specifically, an electromagnetic simulation parametric study has been carried out by means of the commercial *Agilent Momentum* software. A 6-metal layer LTCC technology has been used. Fig. 1 shows a cross section scheme of the Ferro A6 used substrates (dielectric constant, $\epsilon_r = 5.96$, thickness = 3.7 mil). Several layers have been interconnected by means of vias.

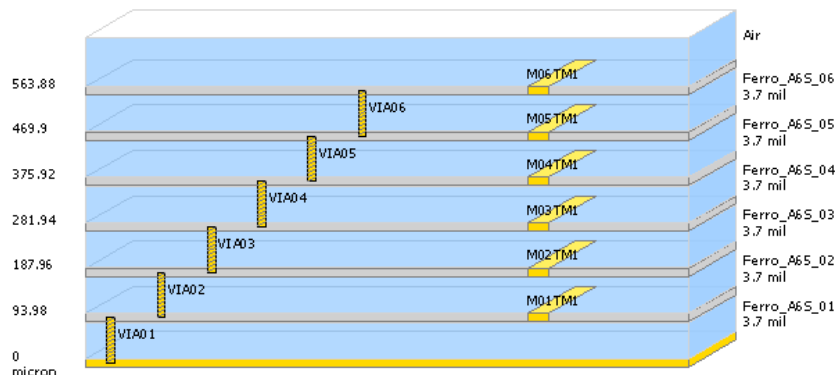

Figure 1: Cross section of the 6 metal layer LTCC technology.

2. INFLUENCE OF THE STRIPLINE RESPECT TO THE Z-POSITION

Before integrating the geometries of the complementary split ring resonators (CSRRs), the stripline itself has been defined. The initial device consists of two $50\ \Omega$ access lines etched on the layer number 6 combined with two connections through vias shortcircuiting the stripline which has been defined in several layers. In this sense, the influence of the position of the stripline and vias in the xyz plane is studied. Fig. 2 shows the two initial symmetrical and non-symmetrical considered topologies. The electromagnetic simulations are devoted to obtain the insertion losses (S_{21} parameter) in several cases. As a generic result a 3 dB better mismatching performance is observed in symmetrical topologies. Therefore, in order to improve the frequency response of the designed Ku-band filters, it has been sought for symmetrical geometries which reduce this mismatching degree and losses. The designed stripline is patterned on different LTCC layers but with the same dimensions that correspond to $10580 \times 200\ \mu\text{m}^2$. Fig. 3 depicts the parametric electromagnetic simulation results corresponding to the insertion losses with regard to the layer position. As can be observed, the mismatching is higher if the layer position is deeper. In addition, the rejection level has been reduced from 6 dB to 2.4 dB which implies a 60% reduction in comparison to the initial symmetrical geometry. Finally, to implement the complementary ring resonators, the designed stripline has been patterned on the LTCC layer number 3 that supposes a rejection level lower than 1 dB.

3. INFLUENCE OF THE NUMBER OF CSRRS IN TERMS OF THE LAYER POSITION

According to the previous results, the filter stripline has been located in the third LTCC layer. As next step, the influence of the number of CSRRs with regard to the layer position has been studied. The CSRRs and the stripline dimensions correspond to $2000 \times 2000\ \mu\text{m}^2$ and $10580 \times 200\ \mu\text{m}^2$, respectively. First it has been analyzed the electromagnetic simulation response when the geometry

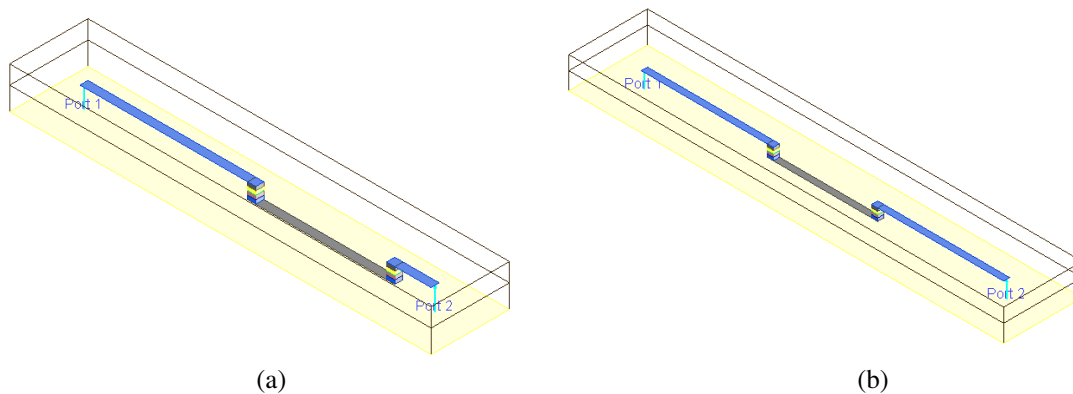

Figure 2: Comparison between (a) symmetrical and (b) non-symmetrical implementation.

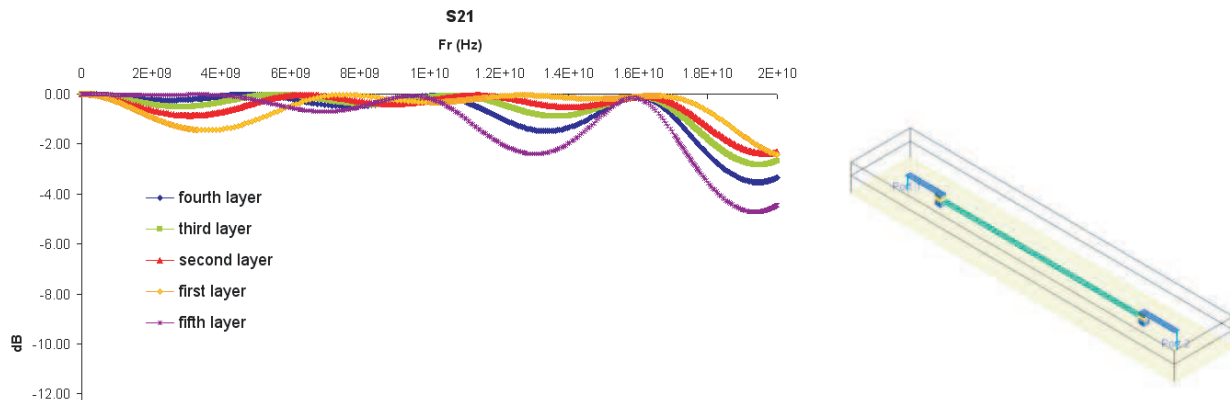

Figure 3: Electromagnetic simulation of the insertion losses of the considered stripline with regard to the layer position in the z -plane.

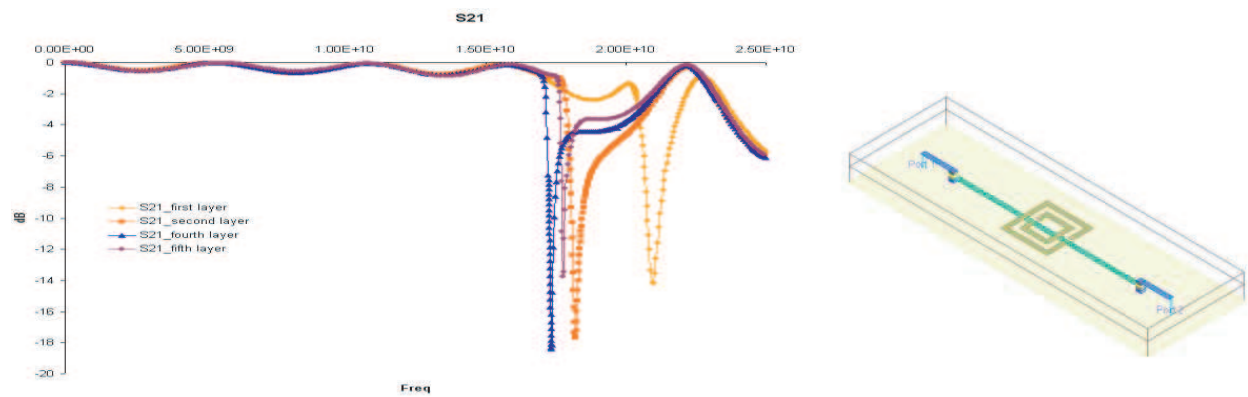

Figure 4: Electromagnetic simulation insertion losses for one CSRR with regard to the layer position.

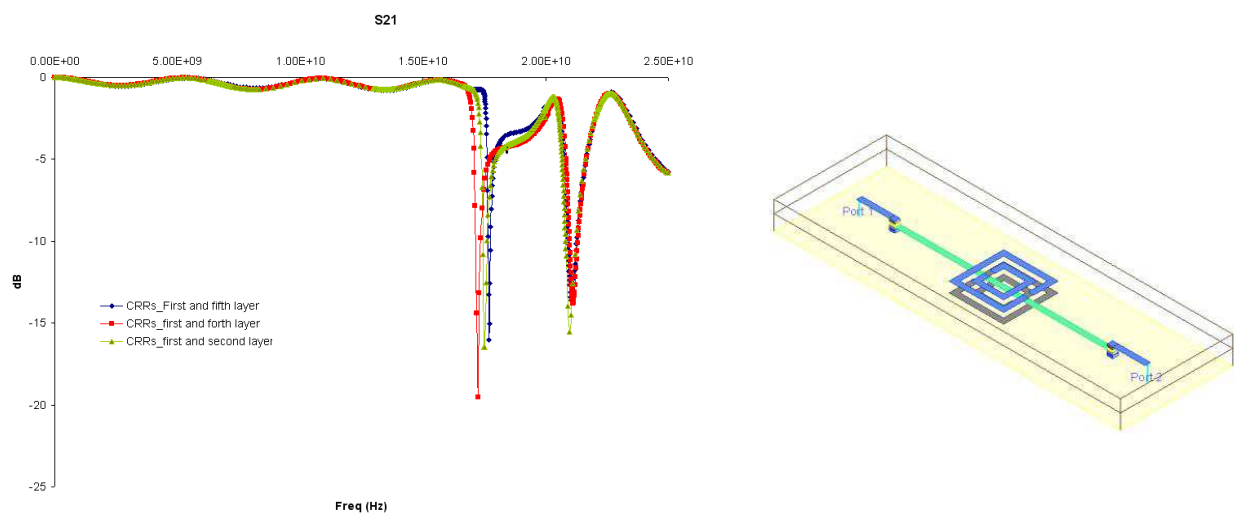

Figure 5: Electromagnetic simulation insertion losses for two CSRR located in different layers.

includes one CSRR in the first, second, fourth and fifth layer. Fig. 4 shows the electromagnetic simulation insertion losses for those different cases. It can be observed that the nearer the CSRR to the host line (layers 2 and 4) the higher the resonance frequency, because of the higher level of electrical coupling. Moreover, the resonance frequency of 2 and 4 layers are quite similar, because the involved equivalent inductors and capacitors are symmetrical. The average level of rejection corresponds to 15 dB.

Secondly, it has been considered the electromagnetic simulation response when the geometry includes two CSRRs located in the same xy position and etched in two different layers (variable z -axis). Fig. 5 shows the electromagnetic simulation insertion losses in those cases. It is observed two resonance peaks at different frequencies due to both CSRR1-host line and CSRR2-host line electrical coupling. Again, the rejection level corresponds to an average value of 15 dB and the undesired presence of an extra resonance implies that those topologies are not optimum.

As third step, the behavior of a structure composed by two CSRRs etched in the same layer has been studied. As depicted in Fig. 6, the best configurations in terms of rejection are obtained for CSRRs located on layers second and fifth by obtaining rejection levels of 40 and 27 dB, respectively. Therefore, in order to improve the rejection level of the proposed stop-band filters it is recommended to use at least two CSRRs in each layer.

A final improved topology is presented in Fig. 7. The best case corresponds to a 2-CSRRs stage etched on layers 2 and 5 simultaneously. The obtained rejection level corresponds to 40 dB achieved around 17.8 GHz, whereas the rest of the band remains matched.

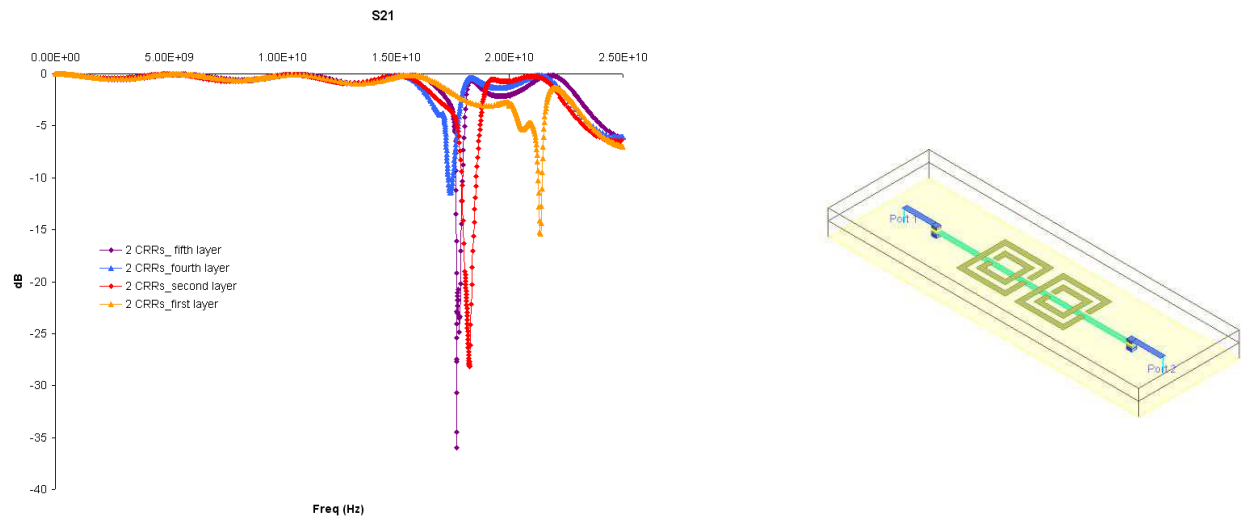

Figure 6: Electromagnetic simulation insertion losses for two CSRRs located in the same layer.

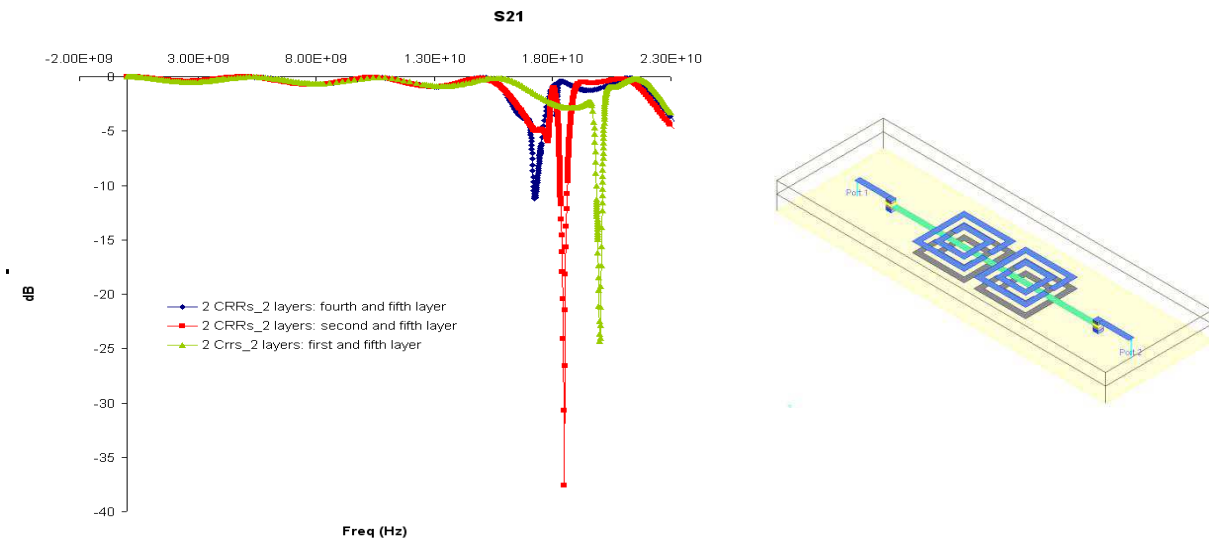

Figure 7: Electromagnetic simulation insertion losses for two CSRRs stage combined in two LTCC layers.

4. CONCLUSIONS

In summary, a parametric design of a Ku-band stop-band pass filter based on RF metamaterials on LTCC technology has been proposed. In order to reduce the number of parameters, the stripline is patterned in the LTCC layer number 3 whereas two CSRRs are etched on layers number 2 and number 5. It has been demonstrated, that these structures open the door to design filters based to stripline RF metamaterials in LTCC technology.

ACKNOWLEDGMENT

This work has been supported by the Spain-MINECO under Project TEC2010-18550 and AGAUR 2009 SGR 1425.

REFERENCES

1. Zhou, J., M. Wei, and B. Li, "Ku-band filters using open-loop and quarter-wavelength resonators based on LTCC technology," *International Conference on Consumer Electronics, Communications and Networks*, 1104–1107, April 2012.
2. Mohra, A. S. and O. F. Siddiqui, "Tunable bandpass filter based on capacitor-loaded metamaterial lines," *Electronics Letters*, Vol. 45, 470–472, April 2009.

3. Pérez, D., I. Gil, J. Gago, R. Fernández, J. Balcells, D. González, N. Berbel, and J. Mon, “Reduction of EMI susceptibility in circuits based on operational amplifiers using complementary split-ring resonators,” *IEEE Transactions on Components, Packaging and Manufacturing Technology*, Vol. 2, 240–247, February 2012.
4. Li, Y., Y. Liu, H. Zhang, D. Lu, L. Bian, and Z. Yang, “The design and fabrication of RF band pass filter by LTCC technology,” *International Conference on Electronic Packaging Technology & High Density, Packaging (ICEPT-HDP 2008)*, 1–4, August 2008.
5. Yang, T., M. Tamura, and T. Itoh, “Super compact low-temperature co-fired ceramic band pass filters using the hybrid resonator,” *IEEE Transaction on Microwave Theory and Techniques*, Vol. 58, 2896–2907, November 2010.