

Active species in N_2 and N_2-O_2 afterglows for surface treatments

This article has been downloaded from IOPscience. Please scroll down to see the full text article.

2010 J. Phys.: Conf. Ser. 207 012006

(<http://iopscience.iop.org/1742-6596/207/1/012006>)

View [the table of contents for this issue](#), or go to the [journal homepage](#) for more

Download details:

IP Address: 147.83.132.21

The article was downloaded on 05/11/2012 at 12:06

Please note that [terms and conditions apply](#).

Active species in N₂ and N₂-O₂ afterglows for surface treatments

A Ricard¹, A M Pointu², S Villeger¹ and C Canal³

¹LAPLACE, Univ. Paul Sabatier, CNRS, 118 route de Narbonne 31062 Toulouse, France

²LPGP, Univ. Paris-Sud, 91405 Orsay, France

³Pharmacy and Pharmaceutical Technology Dpt., University of Barcelona, Avda. Joan XXIII s/n 08028 Barcelona, Spain

E-mail: ricard@laplace.univ-tlse.fr

Abstract. Production of active species is studied in N₂ and in N₂-O₂ afterglows of electrical discharges at low and atmospheric gas pressures. They are produced in microwave discharges in a large range of gas pressures from a few Torr to 100 Torr and in corona discharges at atmospheric gas pressure. The active species in N₂ afterglows are the N-atoms which are in the range of a few percents in the afterglows. The effect of O₂ molecules in low percentages in low pressure N₂ microwave plasmas and as impurity in corona N₂ discharges is specially analysed. The interaction of N and O-atoms with surfaces is studied for bacteria decontamination and for transmission of N-atoms through porous membranes. The processes of bacteria decontamination in N₂-O₂ afterglows are described for low pressure microwave and atmospheric pressure corona discharges. Transmission of N-atoms through porous membranes is studied at medium pressure (10–100 Torr) microwave afterglows.

1. Introduction

In the field of surface modification by plasmas, flowing post-discharges of reactive gases have been recently studied to transform sensitive surfaces at gas temperatures as low as 300 K avoiding the interaction of charged particles (electrons and ions) on the treated surfaces.

In such a way, remote plasma reactors have been implemented for microelectronic applications to obtain oxidized and nitrided silicon thin films [1], for polymer activation to increase surface adhesion [2], for plasma nitriding to enhance hardness and resistance to corrosion of metal surfaces [3], for metal surface cleaning [4] and more recently, for bacterial sterilization [5,6]. In these previous works, flowing plasmas were produced at low gas pressures (1–10 Torr), for an optimum production of active species and to obtain a large diffusion of the species into the post-discharge chamber.

There is also a tendency to work with plasmas at higher pressures, up to the atmospheric gas pressure to avoid any pumping system.

Direct current (DC), radiofrequency (RF) [7] and microwave [8] glow discharges have been used for low pressure plasmas. Dielectric barrier discharge (DBD) [9] and corona [10] are suitable for atmospheric discharges.

In the present paper, production of N and O-atoms in N₂-O₂ flowing post-discharge reactors is presented from low (a few Torr) to high pressures and up to the atmospheric gas pressure.

2. Experimental setup

2.1. The microwave plasma afterglow

The experimental setup used for surface treatments (here bacteria decontamination [6]) in afterglow conditions is reproduced in figure 1. In the first part of the reactor, a discharge is produced in a quartz tube of 5 mm internal diameter by a 2.45 GHz microwave surfatron cavity at powers up to 200 Watt. This small discharge tube is connected to a tube of 18 mm i.d. and up to 30 cm length. The reactor consists of a treatment chamber in pyrex of 15 cm diameter and 20 cm height. The gas flow can vary from 0.1 to 3 slm. The gas pressure in the reactor can be adjusted between 1 and 50 Torr by means of a throttle valve located above the primary pump. Bacterial samples are placed in the center of the post-discharge chamber on a steel holder which can be heated up to 120 °C.

The absolute N and O-atom densities in N₂-O₂ gas mixtures were obtained by the NO titration as detailed in [11].

The optical emission was collected from the afterglow by means of an optical fiber, connected to a Jobin-Yvon 270M spectrometer with a CCD detector.

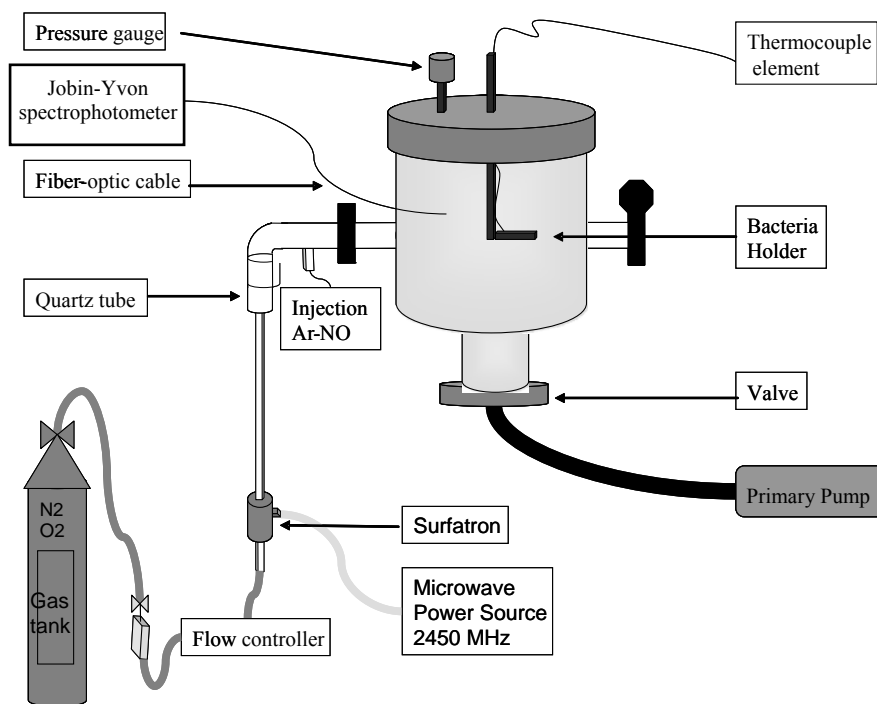

Figure 1. Post-discharge reactor used for bacteria inactivation (LAPLACE – Toulouse)

2.2. The corona discharge reactor

An atmospheric pressure nitrogen afterglow was used as described in [10]. It flows at about 40 slm from successive fast pulsed corona discharges produced between needles with a voltage of some 10 kV, a repetition rate of some 10 kHz and a mean power near 15 W. When contained in a manuril[®] tube (6 mm inner diameter), it produces external fluorescence over more than 10 meters. Such light emissions have been attributed to transported nitrogen atoms.

A high impedance regime of each corona discharge before it is blown up by the gas flow is associated to an energetic electron distribution function able to give a high dissociation efficiency to the discharge. Moreover, the gas temperature is around 300 K.

Thus, in views of the pursued applications, we shall study a cylindrical post discharge, both by measuring the “active” species using spectroscopic means and by testing their biocidal effects.

A typical experimental set up is shown in figure 2.

High purity N₂ gas (99.995 %) is introduced upstream the discharge and, in parallel, a small proportion of O₂ can be added as controlled impurity. Two flow controllers adjust corresponding flows respectively to 40 slm for N₂ and to 0–50 sccm for O₂. After the discharge region, the afterglow is established in a quartz tube of 8 mm internal diameter, ending in the atmospheric air. The emission spectroscopy device (ROPER SCIENTIFIC) is composed of an ACTON spectrometer (0.25 nm resolution with 1200 lines) and a CCD PIXIS-100 detector working from 200 to 1080 nm.

The spectrometer entrance slit is coupled to one end of an optical fiber of 400 μm diameter through a filter used to eliminate higher interference order. The other end of the fiber, covered with a quartz lens, is mobile in parallel with the discharge axis. Spectral acquisition time is around 20 s.

When necessary, biocidal tests are made in the downstream part of tube, inserting a 250 cm³ plastic box containing the biological species (figure 2).

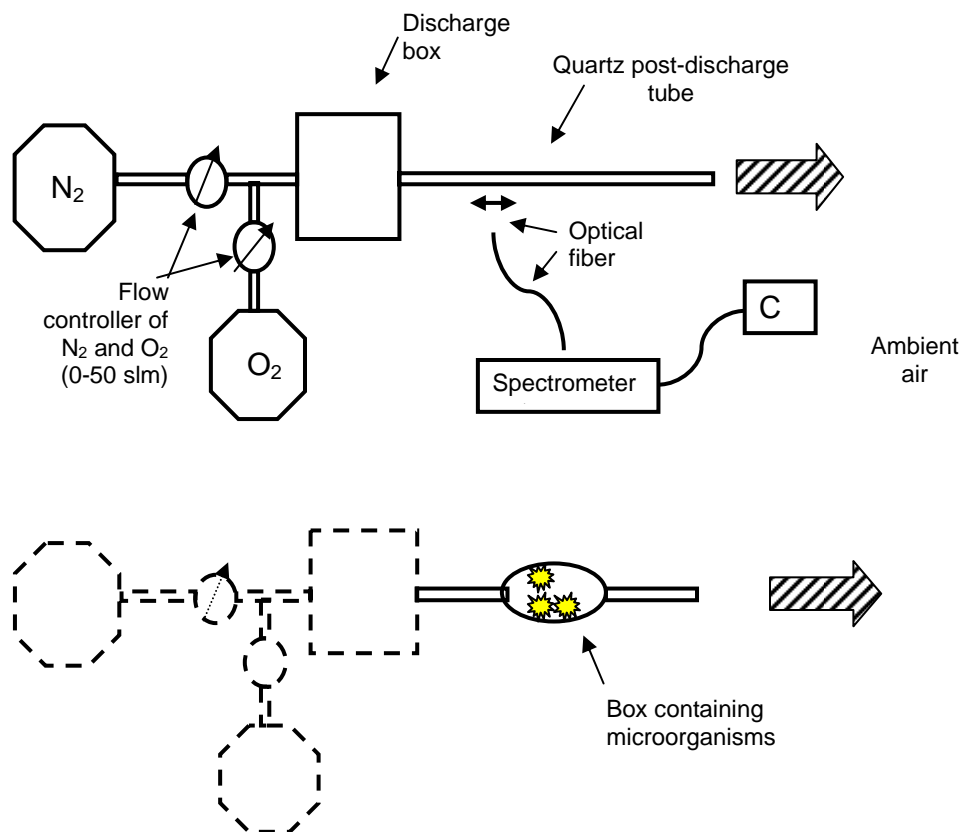

Figure 2. Corona discharge reactor in LPGP-Orsay.

3. Production of excited species in the afterglow

3.1. Afterglows of N₂ and N₂-O₂ flowing microwave discharges

In pure N₂ afterglow, the N-atoms recombine in the gas volume as follows [11,12]:



Reaction (a) produces the N₂-first positive system (FPS) emission from the N₂(B, v' = 11) to the N₂(A, v'') states, with emissions of 540.7 (v'' = 6), 580.4 (v'' = 7) and 625.3 (v'' = 8) bands. The 580.4 nm being the most intense of these three bands is considered as the signature of N-atoms in the afterglow.

As the radiative frequency of N₂ (580 nm) is low ($5 \times 10^4 \text{ s}^{-1}$), it is demonstrated [11] that the quenching of N₂(B, 11) by N₂ is the dominant process at pressures above 1 Torr, so that the intensity of N₂ (580 nm) is proportional to the square of N-atom density:

$$I(580 \text{ nm}) = k [\text{N}]^2. \quad (1)$$

The constant k is calibrated by NO titration as explained in [11].

The homogeneity of the afterglow has been analyzed [13] for several pressures in the reactor of figure 1 by directly connecting the 5 mm quartz tube to the reactor chamber at constant flow rate (1 slm) and microwave power (100 W). It has been found that at a pressure of 4 Torr the afterglow is homogeneous and the same atom density is obtained in several parts of the reactor. At higher pressures, an afterglow jet is observed with an increasingly marked difference in the repartition of N-atoms.

When a few percent of O₂ are introduced into the N₂ microwave discharge there is a production of N and O-atoms by electron collisions on N₂ and O₂ and also UV emission, by the following reaction:

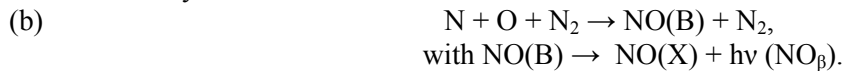

The emission of NO_β bands are found from 300 to 400 nm.

3.2. Afterglows after N₂ corona discharges with O₂ in impurity

In DBD and corona discharges at atmospheric gas pressure, reaction (a) is always present to produce the specific afterglow characteristic of N-atoms.

With an impurity of oxygen from air or with the addition of a low O₂ quantity, as indicated in figure 2, it is observed the following specific emissions [10]:

- the NO_γ bands produced by excitation transfer from N₂(A) metastable molecules :

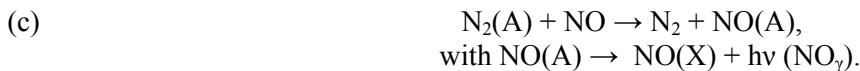

- the NO_β produced by reaction (b).

The NO molecules and the O-atoms in reactions (b) and (c) are produced in the plasma by dissociation of O₂ by electron collisions and by reactions of N-atoms with O₂, as follows:



Reaction (d) is efficient at high discharge temperatures (1000–1500 K) [14].

There is also formation of the N₂O(¹S) excimer by reactions of N₂ with O(¹S) metastable atoms:

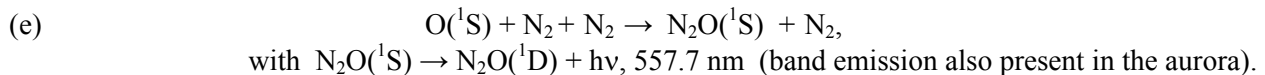

The O(¹S) metastable atom can be excited in the afterglow by collisions of N₂(A) metastable molecules on O-atoms :



The N₂O(¹S) → N₂O(¹D) + hν, 557.7 nm band is thus a signature of N₂(A) metastable molecules.

In the following sections we describe how the emission spectroscopy in the N₂ (N₂-O₂) afterglows can be related to the mechanisms of bacteria inactivation by N and O(¹S) atoms, and by UV emission (section 4), and to the transmission of N-atoms through porous membranes (section 5).

4. Bacteria decontamination

In recent years there has been an increasing interest in plasma technology for bacteria sterilization because of its safe and needs lower temperatures than other treatments [15,16]. Such a plasma process would be useful for complex medical devices that are humidity sensitive and that need to be sterilized at temperatures below 70°C.

4.1. Process in N₂-O₂ and N₂ microwave plasma post-discharges at low gas pressures (1–10 Torr)

The inactivation efficiency of N₂-O₂ microwave flowing post discharges on several bacteria was previously studied [5,6,17,18]. The optimization of the post-discharge process was performed by varying different parameters, such as gas mixture, source power, and gas pressure. For a better understanding of the sterilization mechanisms in post-discharge environments the absolute concentrations of N and O atoms were determined by NO titration.

It has been demonstrated that the efficiency of bacteria sterilization was related to the N and O-atom density as determined by emission spectroscopy and NO titration [17,18]. It has been found that the N and O-atom densities increased with the microwave power. This is a result of the electron density increase in the discharge, which directly affects the production of N and O. The O-atom density increased with the percentage of O₂ in N₂ (from 1 to 8%), while the N atom density decreased sharply. Such a decrease comes from reactions (b) and (d).

The sensitivity of bacteria (*E-coli*) to the post-discharge was studied in the reactor reported in figure 1. With a N₂-O₂ plasma the sterilizing agents are the N and O-atoms and the UV emission of NO_β, which is produced by the recombination reaction (b).

E-coli bacteria were diluted into LB broth (Lurian Bertani broth) and deposited inside small sterile aluminium cylinders (diameter 5 mm, height 10 mm). The cylinders were placed on the holder as indicated in figure 1. By pumping down to about 10⁻² Torr, the liquid part of the LB broth was evaporated. It has been checked that about 10% of bacteria remained alive after this operation. Then the dried bacteria and the broth macromolecules were exposed to the N₂-5%O₂ post discharge at 100 watt with a pressure of 5 Torr, and a flow rate of 1 slm. The N₂-5%O₂ gas mixture was chosen because it represents a good compromise to obtain significant values of both N and O-atom density and NO_β UV intensity.

The sample holder can be heated up to 120°C and the holder temperature can contribute to the reduction of the sterilization time. As shown in figure 3, a reduction of 6 log of *E-coli* is observed after treatment times of 2, 25 and 30 minutes with an external heating of the stainless steel holder at 120, 80 and 60 °C, respectively. Moreover, a bacterial reduction of 12 Log was obtained in 5 minutes at 120 °C. An external heating at 120 °C alone, without plasma, only achieved a reduction of 6 log in 30 minutes (not shown in figure 3, but verified).

Such results indicate the synergy of the metal holder temperature and of the active species for an efficient bacteria inactivation in the post-discharge. It seems that the N and O-atoms interact by an etching process on the bacteria membranes. A small increase of the substrate temperature – up to 120 °C in the present experiment – seems to favor desorption of etched products. The increase of N atoms diffusion inside the bacteria as the temperature increased can also be relevant.

The bacteria inactivation has also been investigated in pure N₂ afterglow in standard conditions of 4 Torr, 1 slm and 100 W. The results are reproduced in figure 4 for *E-coli* bacteria diluted inside two different media: LB broth and sterile water, which were then dried in vacuum.

A complete bacteria inactivation was obtained when bacteria were initially (before pumping) in suspension in water at concentrations lower than 10⁸ cfu/cm³. Sterilization (decrease of 6 log) is achieved after 30 minutes of treatment at ambient temperature.

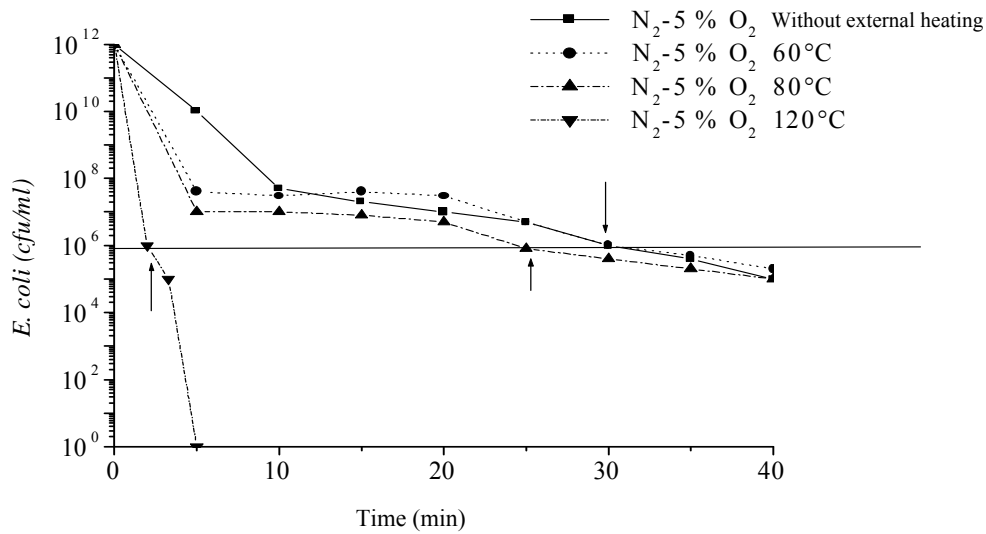

Figure 3. Variations of E-coli survivors versus N_2 -5% O_2 afterglow treatment time for several substrate temperatures

Sterilization is more efficient when bacteria are prepared in water, indicating a shadow effect of dried macromolecules from the LB broth.

When bacteria are prepared in LB or in water at high concentrations (10^{10} cfu/cm³) no sterilization is observed.

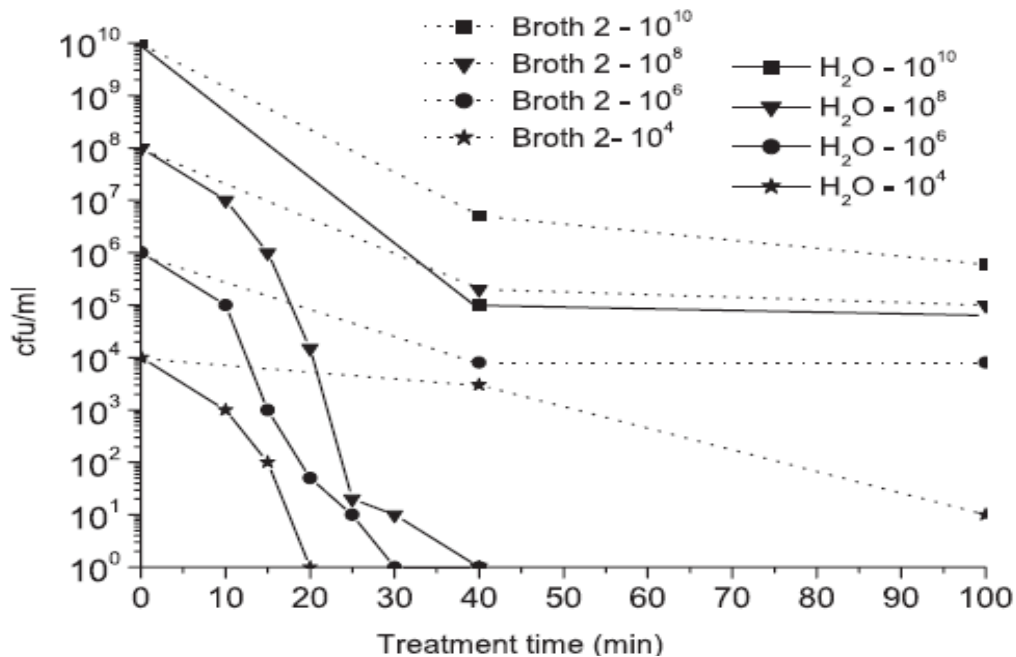

Figure 4. *E. coli* inactivation in N_2 post-discharge versus the treatment time with dilutions of bacteria in Broth 2 (LB) and sterile water [13] 1 slm, 100 W , 4 Torr, 300 K.

By comparing with N₂-5%O₂ post-discharge without external heating (figure 3), the pure N₂ post-discharge is less efficient with the LB broth than the N₂-5%O₂ gas mixture.

However, pure N₂ post-discharges are not oxidizing processes, which is efficient when bacteria are diluted and dried in water media. The etching of bacteria is accelerated by heating the substrate up to 60 °C, which is compatible with a cold sterilization process.

4.2. Process in N₂ corona discharge at atmospheric gas pressure. Effect of O₂ impurities

The N-atom density has been determined by NO titration in [10] as being of 5×10¹⁴ cm⁻³, keeping a nearly constant value up to a quantity of 5×10⁻³ O₂ into N₂. By comparing the I_{N₂}(580 nm) and I_{N₂O*}(557.7 nm) band intensities resulting of reactions (a) and (e, f), it is obtained the order of magnitude of the O(¹S) metastable density with a maximum value of 7×10¹⁰ cm⁻³ for (2.5–5)×10⁻⁵ O₂ into N₂.

Considering the results of spores decontamination (*Bacillus Stearotermophilus*) as reproduced in table 1, it can be deduced that the best results are obtained with the N₂ – 2.5×10⁻⁵ O₂ gas mixture when I_{N₂O*}(557.7 nm) and thus the O(¹S) density reached a maximum value. The results showed that a small density of O(¹S) was efficient in the sterilization process.

Table 1. Number of *Bacillus Stear* spores survivors versus exposure times to the corona post-discharge. Effect of addition to N₂ of small O₂ quantities [10].

Exposure time (min)	[O ₂]/[N ₂] ratio		
	0	2.5×10 ⁻⁵	2.5×10 ⁻⁴
0	21400	22200	18600
15	1195	130	350
30	595	105	250

5. Transmission of N-atoms through porous membranes

The interaction of N-atoms with nonwoven membranes was investigated on nylon (5 μm) made by co-solvent evaporation from a nylon extruded film and polypropylene (PP) prepared from polypropylene fibers by a melt-blown process, which were exposed as shown in figure 5 to the N₂ flowing (1 slm) microwave (100 Watt) post discharge produced at low gas pressures: from 1 to 30 Torr [19,20,21]. The N atoms transmission through these membranes was measured from the intensity variation of the N₂ (580 nm) afterglow, which results of N atom recombination (reaction (a)), before and after the membranes.

As shown in figure 5, the afterglow emission was collected by a quartz optical fiber which can be fixed in positions 1 or 2 (P₁ and P₂, before or after the membrane) and sent to the entrance slit of the spectrometer as in figure 1.

In order to study the transmission of N-atoms, the nonwoven membranes were set-up across the 18 mm i.d tube, as detailed in figure 5, after the 5 mm i.d discharge tube and before the reactor inlet.

By considering equation (2), the N atom transmission (T_N) through the membranes can be calculated as follows:

$$T_N = \frac{[N]_{P2}}{[N]_{P1}} = \frac{\sqrt{I_{P2}}}{\sqrt{I_{P1}}} \quad (2)$$

After the PP membranes it was observed that the 580 nm intensity was lower than before the membranes and that it kept a nearly constant value up to 30 minutes of post-discharge [21]. This indicates a constant N density after the membranes, which results in a constant T_N value for afterglow times up to 30 minutes.

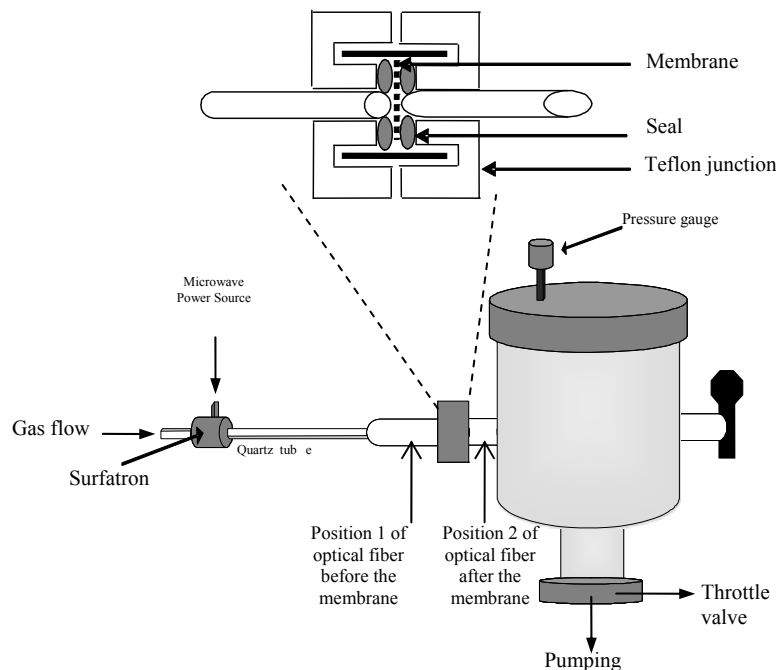

Figure 5. Microwave flowing afterglow reactor. Detail of the membrane insertion in a Teflon junction in the 18 mm id. quartz tube [19].

The mean value of N atom transmission calculated was $T_N = 0.43 \pm 0.03$. This constant N atom transmission through the polypropylene membrane indicates that no significant alterations are produced by the afterglow on the main structure or on the porosity of the membranes, as confirmed by SEM [21].

With the nylon 5 μm membrane, T_N increased from 0.1 to 0.5 after 30 minutes of afterglow time. The increase with treatment time of N atom density after the membrane indicated that the post-discharge treatment produced important alterations on the membrane. In a previous work [19], SEM revealed an increase of the nylon pore size through etching reactions of N atoms with the nylon surface.

Investigations with other membranes also found that T_N increased after 30 min of post-discharge from 0.5 to 1 with PDVF (pores 1 μm) and from 0.33 to 1 with polysulfones (pores 1–3 μm) [20].

Previous results on the treatment of polymer fibers with plasmas pointed out to a preferential etching effect on low crystallinity regions (amorphous regions) [22]. It is known that the drawing of the fibers during the spinning process to produce fibers induces orientation of the polymer chains in the fiber axis resulting in increased crystallinity. According to the fabrication process of the nylon and polypropylene nonwovens, as well as to the SEM micrographs, it can be speculated that the melt-blown spinning process of PP produces a polymer with higher crystallinity than the nylon obtained from a non-oriented polymer film, which is more easily etched by N atoms.

In addition to that, the chemical structures of PP and nylon have to be taken into account in what regards the etching effect. The presence of amide bonds in the nylon molecule provides a point with higher reactivity towards the N atoms than the aliphatic C-C bindings present in the PP molecule, justifying the intense etching effect (and increasing T_N) observed in nylon membranes.

6. Conclusion

Two flowing $\text{N}_2\text{-O}_2$ post-discharges have been studied and applied to bacteria sterilization.

The first one is produced by a microwave plasma at reduced gas pressure (1 – 50 Torr) and middle flow rates (0.1 – 3 slm). The second one is a Corona discharge at atmospheric gas pressure and high flow rate (40 slm).

The afterglow has been analysed by emission spectroscopy with detection of N and O atoms whose absolute density has been obtained by NO titration.

The main kinetic reactions in the N₂-O₂ afterglows are reported, showing that the most relevant active species for bacteria sterilization are the N and O-atoms and UV emission at reduced gas pressure with in addition the O(¹D) and N₂(A) metastable atoms and molecules in the Corona post-discharge at atmospheric pressure.

In the microwave post-discharge reactor at reduced gas pressure, it is reported a synergetic effect in the bacteria destruction of gas temperature and density of N and O-atoms with UV emission. Also, it has been found that the macromolecules from the broth, surrounding the bacteria, reduced the bacteria destruction.

In the Corona post-discharge at atmospheric pressure, the N₂(A) and O(¹D) metastables interacted in addition to the N and O atoms in the bacteria (spores) inactivation.

The transmission of N-atoms through membranes, in view to preserve the sterilization of medical instruments, have been measured in the microwave post-discharge reactor. The best results (transmission of 43 %) were obtained with the polypropylene membrane without a marked etching effect after 30 minutes of treatment.

References

- [1] Kulich W 1993 *Surf. Coat. Technol.* **59** 193
- [2] Normand F, Granier A, Leprince P, Marec J, Shi M K and Clouet F 1995 *Plasma Chem. Plasma Process.* **15** 173
- [3] Ricard A, Oseguera-Pena J, Michel H and Gantois M 1990 *IEEE Trans. Plasma Sci.* **18C** 940
- [4] Gaillard M, Raynaud P and Ricard A 1999 *Plasmas Polym.* **4** 241
- [5] Moreau S, Moisan M, Tabrizian M, Barbeau J, Pelletier J, Ricard A and Yahia L'H 2000 *J. Appl. Phys.* **88** 1166
- [6] Villeger S, Cousty S, Ricard A and Sixou M 2003 *J. Phys. D* **36** L60
- [7] Chapman B 1980 *Glow Discharge Processes* Wiley
- [8] Moisan M and Pelletier J 1992 *Microwave excited plasma* Elsevier
- [9] Massines F, Segur P, Gherardi N, Khamphan C and Ricard A 2003 *Surf. Coat. Tech.* **8** 174–5
- [10] Pointu A M, Ricard A, Dodet B, Odic E, Larbre J and Ganciu M 2005 *J. Phys. D* **38** 1905
- [11] Boudam M K, Saoudi B, Moisan M and Ricard A 2007 *J. Phys. D* **40** 1694
- [12] Czerwiec T, Gavillet G, Belmonte T, Michel H and Ricard A 1996 *J. Phys III (Paris)* **6** 1205
- [13] Cousty S, Villeger S, Sarrette J P, Ricard A and Sixou M 2006 *Eur. Phys. J. AP* **34** 143
- [14] Gordiets B and Ricard A 1993 *Plasma Sources Sci. Tech.* **2** 158
- [15] Cariou S, Gauthier M and Glénat M C *Decontamination, bionettoyage, desinfection, sterilisation* Edit. Masson (4th ed. 2000)
- [16] Block S S *Desinfection, sterilization and preservation* Edit. LWW (5th ed. 2001)
- [17] Villeger S, Ricard A and Sixou M 2004 *Eur. Phys. J. AP* **26** 203–8
- [18] Villeger S, Sarrette J P and Ricard A 2005 *Plasma Process. Polym.* **2** 709
- [19] Villeger S, Sixou M, Durand J and Ricard A 2006 *J. Phys. D* **39** 3826
- [20] Villeger S, Sixou M, Durand J and Ricard A 2007 *Plasma Process. Polym.* **4** 150
- [21] Ricard A, Gaboriau F and Canal C 2008 *Optical spectroscopy to control a plasma reactor for surface treatments.* Surf. Coatings Tech.
- [22] Canal C 2005 *PhD Thesis - Universitat Politècnica de Catalunya*
<http://www.tesisenxarxa.net/TDX-0426107-123209/index.html>