

Deterministic Hierarchical Networks

L. Barrière, F. Comellas*, C. Dalfó, M.A. Fiol,

*Departement de Matemàtica Aplicada IV
Universitat Politècnica de Catalunya
Barcelona, Catalonia (Spain)*

Abstract

Recently it has been shown that many networks associated with complex systems are small-world (they have both a large local clustering and a small diameter) and they are also scale-free (the degrees are distributed according to a power-law). Moreover, these networks are very often hierarchical, as they describe the modularity of the systems which are modeled. Most of the studies for complex networks are based on stochastic methods. However, a deterministic method, with an exact determination of the main relevant parameters of the networks, has proven useful. Indeed, this approach complements and enhances the probabilistic and simulation techniques and, therefore, it provides a better understanding of the systems modeled.

In this paper we find the radius, diameter, clustering and degree distribution of a generic family of deterministic hierarchical small-world scale-free networks which has been considered for modeling real life complex systems. Moreover a routing algorithm is proposed.

Key words: Hierarchical network, Small-world, Scale-free, Degree, Routing algorithm, Diameter, Clustering.

1 Introduction

With the publication in 1998 and 1999 of the papers by Watts and Strogatz on small-world networks [21] and by Barabási and Albert on scale-free networks [3], there has been a renewed interest in the study of networks associated to complex systems which has received a considerable boost as an interdisciplinary subject.

Many real life networks, transportation and communication systems (including the power distribution and telephone networks), Internet [9], World Wide Web [2],

* Corresponding author. Tel. +34 93 413 7072; Fax +34 93 413 7007.

Email addresses: lali@ma4.upc.edu (L. Barrière), comellas@ma4.upc.edu (F. Comellas), cdalfo@ma4.upc.edu (C. Dalfó), fiol@ma4.upc.edu (M.A. Fiol).

and several social and biological networks [10,11,13], belong to a class of networks known as small-world scale-free networks. All these networks exhibit both a strong local clustering (nodes have many mutual neighbors) and a small diameter. Another important characteristic is that the number of links attached to the nodes usually obeys a power-law distribution (“scale-free” network). Several authors also noticed that the modular structure of a network can be characterized by a specific clustering distribution which depends on the degree. The network is then called hierarchical [18,20,22]. Moreover, with the introduction of a new measuring technique for graphs, it has been discovered that many real networks can also be categorized as self-similar, see [19].

Along with these observational studies, researchers have developed different models [1,8,14], most of them stochastic, which should help to understand and predict the behavior and characteristics of complex systems. However, new deterministic models constructed by recursive methods, based on the existence of “cliques” (clusters of nodes linked to each other), have also been introduced [5,6,7,12,23]. Such deterministic models have the advantage that they allow one to compute analytically relevant properties and parameters, which may be compared with data from real and simulated networks. In [5], Barabási *et al.* proposed a simple hierarchical family of deterministic networks and showed it had a small-world scale-free nature. However, their clustering is zero, in contrast with many real networks which have a high clustering. Another family of hierarchical networks is proposed in [18]. It combines a modular structure with a scale-free topology and models the metabolic networks of living organisms and networks associated with generic system-level cellular organizations. A simple variation of this hierarchical network is considered in [17], where the authors study other modular networks as WWW, the actor network, Internet at the domain level, etc. This model is further generalized in [16].

In this paper, we study a family of hierarchical networks recursively defined from an initial complete graph on n vertices. We find some of the main properties for this family: routing, radius, diameter, and degree and clustering distributions.

2 The hierarchical graph $H_{n,k}$

In this section we generalize the constructions of deterministic hierarchical graphs introduced by Ravasz *et al.* [17,18] and Noh [16]. Roughly speaking, these graphs are constructed first by connecting a selected root vertex of a complete graph K_n to some vertices of $n - 1$ replicas of K_n , and establishing also some edges between such copies of K_n . This gives a graph with n^2 vertices. Next, $n - 1$ replicas of the new whole structure are added, again with some edges between them and to the same root vertex. At this step the graph has n^3 vertices. Then we iterate the process until the desired graph order n^k , for some integer $k \geq 1$, is reached (see below for a formal definition). Our model enhances the modularity and self-similarity of the graph obtained, and allows us to design a routing algorithm, and to derive exact expressions for the radius, diameter, degree and clustering distributions.

2.1 Definition, order and size

Next we provide a recursive formal definition of the proposed family of graphs, characterized by the parameters $n \geq 2$ (order of the initial complete graph) and $k \geq 1$ (number of iterations or dimension). This allows us to give also a direct definition and derive an expression for the number of edges (the radius and the diameter will be studied in the next section).

Definition 2.1 *Let n, k be positive integers, $n \geq 2$. The hierarchical graph $H_{n,k}$ has vertex set $V_{n,k}$, with n^k vertices denoted by the k -tuples $x_1x_2x_3 \dots x_k$, $x_i \in \mathbb{Z}_n, 0 \leq i \leq k-1$, and edge set $E_{n,k}$ defined recursively as follows:*

- $H_{n,1}$ is the complete graph K_n .
- For $k > 1$, $H_{n,k}$ is obtained from the union of n copies of $H_{n,k-1}$, denoted by $H_{n,k-1}^\alpha$, $0 \leq \alpha \leq n-1$, and with vertices $x_2^\alpha x_3^\alpha \dots x_k^\alpha \equiv \alpha x_2 x_3 \dots x_k$, by adding the following new edges:

$$000 \dots 00 \sim x_1 x_2 x_3 \dots x_{k-1} x_k, \quad x_j \neq 0, \quad 1 \leq j \leq k; \quad (1)$$

$$x_1 00 \dots 00 \sim y_1 00 \dots 00, \quad x_1, y_1 \neq 0, \quad x_1 \neq y_1. \quad (2)$$

Alternatively, a direct definition of the edge set $E_{n,k}$ is given by the following adjacency rules:

$$x_1 x_2 \dots x_k \sim x_1 x_2 \dots x_{k-1} y_k, \quad y_k \neq x_k; \quad (3)$$

$$x_1 x_2 \dots x_i 00 \dots 0 \sim x_1 x_2 \dots x_i x_{i+1} x_{i+2} \dots x_k, \quad (4)$$

$$x_j \neq 0, \quad i+1 \leq j \leq k, \quad 0 \leq i \leq k-2;$$

$$x_1 x_2 \dots x_i 00 \dots 0 \sim x_1 x_2 \dots x_{i-1} y_i 00 \dots 0, \quad (5)$$

$$x_i, y_i \neq 0, \quad y_i \neq x_i, \quad 1 \leq i \leq k-1.$$

Notice that both conditions (1) and (2) of the recursive definition correspond to (4) with $i = 0$, and (5) with $i = 1$, respectively.

To illustrate our construction, Fig. 1 shows the hierarchical graphs $H_{4,k}$, for $k = 1, 2, 3$. The following result gives the number of edges of $H_{n,k}$, which can be easily computed by using the recursive definition.

Proposition 2.2 *The size of $H_{n,k}$ is*

$$|E_{n,k}| = \frac{3}{2}n^{k+1} - (n-1)^{k+1} - 2n^k - \frac{n}{2} + 1. \quad (6)$$

Proof. When constructing $H_{n,k}$ from n copies of $H_{n-1,k}$, the adjacencies (1) and (2) introduce $(n-1)^k$ and $\binom{n-1}{2}$ new edges, respectively. Therefore,

$$|E_{n,k}| = n|E_{n,k-1}| + (n-1)^k + \binom{n-1}{2}.$$

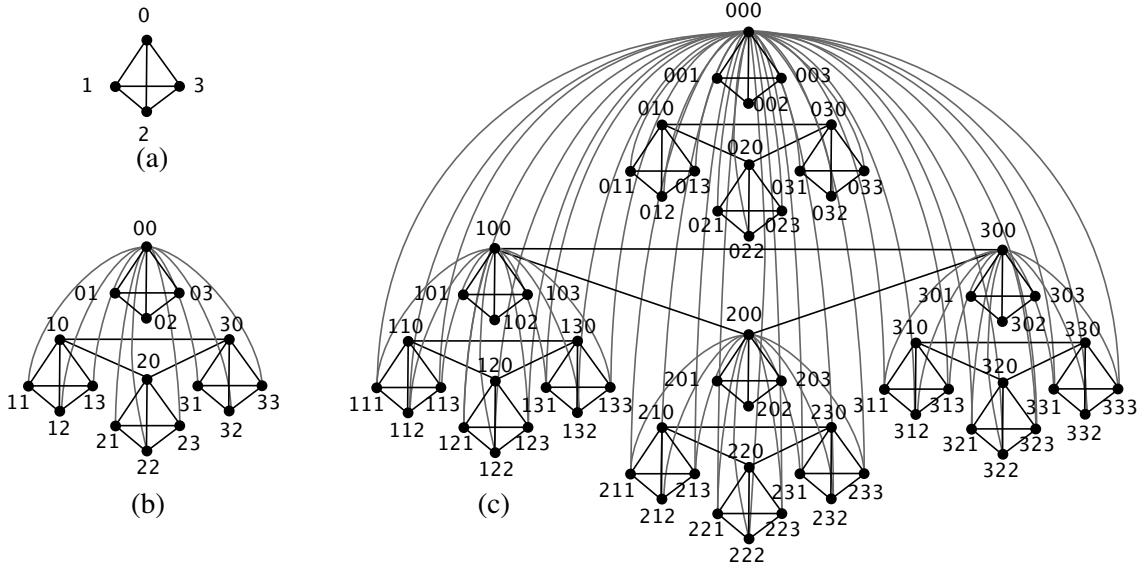

Figure 1. Hierarchical graphs with initial order 4: (a) $H_{4,1}$, (b) $H_{4,2}$, (c) $H_{4,3}$

By applying recursively this formula and taking into account that $|E_{n,1}| = \binom{n}{2}$, we get

$$|E_{n,k}| = n^{k-1} \binom{n}{2} + \sum_{i=2}^k n^{k-i} (n-1)^i + \binom{n-1}{2} \sum_{i=0}^{k-2} n^i, \quad (7)$$

which yields the result. \square

In fact, notice that the three summands in (7) correspond to the number of edges defined by the adjacencies (3), (4) and (5), respectively. Indeed,

- By (3) we have n^{k-1} complete subgraphs K_n , whose number of edges adds up to

$$n^{k-1} \binom{n}{2} = n^k \frac{n-1}{2}. \quad (8)$$

- The number of edges induced by (4) is

$$\sum_{i=0}^{k-2} n^i (n-1)^{k-i} = \frac{n^{k-2} (n-1)^2 \frac{n}{n-1} - (n-1)^k}{\frac{n}{n-1} - 1} = (n-1)^2 n^{k-1} - (n-1)^{k+1}. \quad (9)$$

- By (5), and for $i = 1, 2, \dots, k-1$, we get n^{i-1} subgraphs isomorphic to K_{n-1} with the following total number of edges:

$$\binom{n-1}{2} \sum_{i=1}^{k-1} n^{i-1} = \frac{1}{2} (n-2) (n^{k-1} - 1). \quad (10)$$

2.2 Hierarchical properties

The hierarchical properties of the graphs $H_{n,k}$ are summarized by the following facts which are direct consequences of the definition:

- (a) According to (3), for each sequence of fixed values $\alpha_i \in \mathbb{Z}_n$, $1 \leq i \leq k-1$, the vertex set $\{\alpha_1\alpha_2 \dots \alpha_{k-1}x_k : x_k \in \mathbb{Z}_n\}$ induces a subgraph isomorphic to K_n .
- (b) Vertex $\mathbf{r} := 00 \dots 0$, which we distinguish and call *root*, is adjacent by (4) to vertices $x_1x_2 \dots x_k$, $x_i \neq 0$, $1 \leq i \leq k$, which we call *peripheral*.
- (c) For every i , $1 \leq i \leq k-1$, $H_{n,k}$ can be decomposed into n^i vertex-disjoint subgraphs isomorphic to $H_{n,k-i}$. Each of such subgraphs is denoted by $H_{n,k-i}^\alpha$ and has vertex labels $\alpha x_{i+1}x_{i+2} \dots x_k$, with $\alpha = \alpha_1\alpha_2 \dots \alpha_i \in \mathbb{Z}_n^i$ being a fixed sequence. In particular, for $i=1$, $H_{n,k}$ has n subgraphs $H_{n,k-1}^\alpha$, $\alpha = 0, 1, \dots, n-1$, as stated in the recursive definition.
- (d) The root vertex of the subgraph $H_{n,k-i}^\alpha$ is $\alpha 00 \dots 0$. Thus, the total number of root vertices, including the one in $H_{n,k}$, is

$$1 + (n-1) \sum_{i=1}^{k-1} n^{i-1} = n^{k-1}, \quad (11)$$

as expected since a given vertex $x_1x_2 \dots x_k$ is a root (of some subgraph) if and only if $x_k = 0$.

- (e) The peripheral vertices of the subgraph $H_{n,k-i}^\alpha$ are of the form $\alpha x_{i+1}x_{i+2} \dots x_k$, where $x_j \neq 0$, $i+1 \leq j \leq k$. Thus, the total number of peripheral vertices, including those in $H_{n,k}$, see (b), is

$$(n-1)^k + (n-1) \sum_{i=1}^{k-1} n^{i-1}(n-1)^{k-i} = n^{k-1}(n-1), \quad (12)$$

as expected since $x_1x_2 \dots x_k$ is a peripheral vertex (of some subgraph) if and only if $x_k \neq 0$. Note that adding up (11) and (12) we get $n^k = |V_{n,k}|$, so that every vertex of $H_{n,k}$ is a root or peripheral of some subgraph isomorphic to $H_{n,k'}$, $1 \leq k' \leq k$.

- (f) By collapsing in $H_{n,k}$ each of the n^i subgraphs $H_{n,k-i}^\alpha$, $\alpha \in \mathbb{Z}_n^i$, into a single vertex and all multiple edges into one we obtain a graph isomorphic to $H_{n,i}$.
- (g) According to (5), for every fixed i , $1 \leq i \leq k$, and given sequence $\alpha \in \mathbb{Z}_n^{i-1}$, there exist all possible edges among the $n-1$ vertices labeled $\alpha x_i 00 \dots 0$ with $x_i \in \mathbb{Z}_n^* = \{1, 2, \dots, n-1\}$; that is, the root vertices of $H_{n,k-i}^{\alpha x_i}$. Thus, these edges induce a complete graph isomorphic to K_{n-1} .

3 Routing and Diameter

This section introduces a routing algorithm for $H_{n,k}$. The algorithm is useful in the determination of the radius, eccentricity of the root, and the diameter of $H_{n,k}$. The diameter has also been determined using recursive methods.

3.1 Routing

Let us consider two vertices in $H_{n,k}$, say $\mathbf{x} = x_1x_2 \dots x_k$ and $\mathbf{y} = y_1y_2 \dots y_k$. Now a routing from \mathbf{x} to \mathbf{y} consists of the following steps, where the symbols with an asterisk as a superscript are supposed to be in $\mathbb{Z}_n^* := \mathbb{Z}_n - 0 = \{1, 2, \dots, n-1\}$. The key idea is to go first from \mathbf{x} to the root \mathbf{r} and then from \mathbf{r} to \mathbf{y} .

- Step 1:

- (a) If $x_{k-1} \neq 0$ and $x_k = 0$, then go from \mathbf{x} to $\mathbf{x}_1^* = x_1x_2 \dots x_{k-2}x_{k-1}^*x_k^*$;
if $x_{k-1}, x_k \neq 0$, then simply take $\mathbf{x}_1^* = \mathbf{x}$.
- (b) If $x_{k-1} = 0$ and $x_k \neq 0$, then go from \mathbf{x} to $\mathbf{x}_1^0 = x_1x_2 \dots x_{k-2}00$;
if $x_{k-1} = x_k = 0$, then simply take $\mathbf{x}_1^0 = \mathbf{x}$.

- Step 2:

- (a) Assuming we have taken Step 1(a), if $x_{k-2} = 0$, then go from \mathbf{x}_1^* to $\mathbf{x}_2^0 = x_1x_2 \dots x_{k-3}000$. Otherwise, if $x_{k-2} \neq 0$, then let $\mathbf{x}_2^* = \mathbf{x}_1^*$.
- (b) Assuming we have taken Step 1(b), if $x_{k-2} \neq 0$, then go from \mathbf{x}_1^0 to $\mathbf{x}_2^* = x_1x_2 \dots x_{k-3}x_{k-2}^*x_{k-1}^*x_k^*$. Otherwise, if $x_{k-2} = 0$, then let $\mathbf{x}_2^* = \mathbf{x}_1^*$.

⋮

- Step $k-1$ (with k odd, the case of even k being similar):

- (a) Assuming we have taken Step $(k-2)(a)$, if either $x_1 = 0$ or $x_1, y_1 \neq 0$, then go from $\mathbf{x}_{k-2}^* = x_1x_2^*x_3^* \dots x_k^*$ to $\mathbf{x}_{k-1}^0 = 000 \dots 0 = \mathbf{r}$. Otherwise, if $x_1 \neq 0, y_1 = 0$, then let $\mathbf{x}_{k-1}^* = \mathbf{x}_{k-2}^* = x_1^*x_2^* \dots x_k^*$.
- (b) Assuming we have taken Step $(k-2)(b)$,
 - (b1) if $x_1 \neq 0$ and $y_1 = 0$, then go from $\mathbf{x}_{k-2}^0 = x_100 \dots 0$ to $\mathbf{x}_{k-1}^* = x_1^*x_2^* \dots x_k^*$,
 - (b2) if $x_1, y_1 \neq 0$ and $y_1 \neq x_1$, then go from \mathbf{x}_{k-2}^0 to $\mathbf{y}_{k-2}^* := y_100 \dots 0$. Otherwise, if $y_1 = x_1$, then let $\mathbf{y}_{k-2}^* = \mathbf{x}_{k-2}^0$,
 - (b3) if $x_1 = 0$, then let $\mathbf{x}_{k-1}^0 = \mathbf{x}_{k-2}^0 = \mathbf{r}$.

- Step k :

- (a) Assuming we have taken Step $(k-1)(a)$, if $y_1 \neq 0$, then go from $\mathbf{x}_{k-1}^0 = \mathbf{r}$ to $\mathbf{y}_{k-1}^* = y_1y_2^*y_3^* \dots y_k^*$, where $y_i^* = y_i$ for every $2 \leq i \leq k$ such that $y_i \neq 0$. Otherwise, if $y_1 = 0$, then let $\mathbf{y}_{k-1}^0 = \mathbf{x}_{k-1}^0 = \mathbf{r}$.
- (b) Assuming we have taken Step $(k-1)(b)$,
 - (b1) if we have taken Step (b1), where $x_1 \neq 0, y_1 = 0$, then go from $\mathbf{x}_{k-1}^* = x_1^*x_2^* \dots x_k^*$, to $\mathbf{y}_{k-1}^0 = 00 \dots 0 = \mathbf{r}$,
 - (b2) if we have taken Step (b2), where $x_1, y_1 \neq 0$, then go on from $\mathbf{y}_{k-2}^* := y_100 \dots 0$,
 - (b3) if we have taken Step (b3), where $x_1 = 0$, then proceed as in the above case (a).

- Steps $k+1, k+2, \dots, 2k-1$:

Go from either, $\mathbf{r} = 00 \dots 0$, $\mathbf{y}_{k-2}^* := y_100 \dots 0$ or $\mathbf{y}_{k-1}^* = y_1y_2^*y_3^* \dots y_k^*$, following the above k steps in inverse order, until reaching vertex $\mathbf{y} = y_1y_2 \dots y_k$.

For a better understanding of the above procedure, a diagram of this algorithm for the case $k = 5$ is depicted in Fig. 2. Continuous lines correspond to going through an edge (that is, adjacency between vertices), whereas dashed lines indicate that we

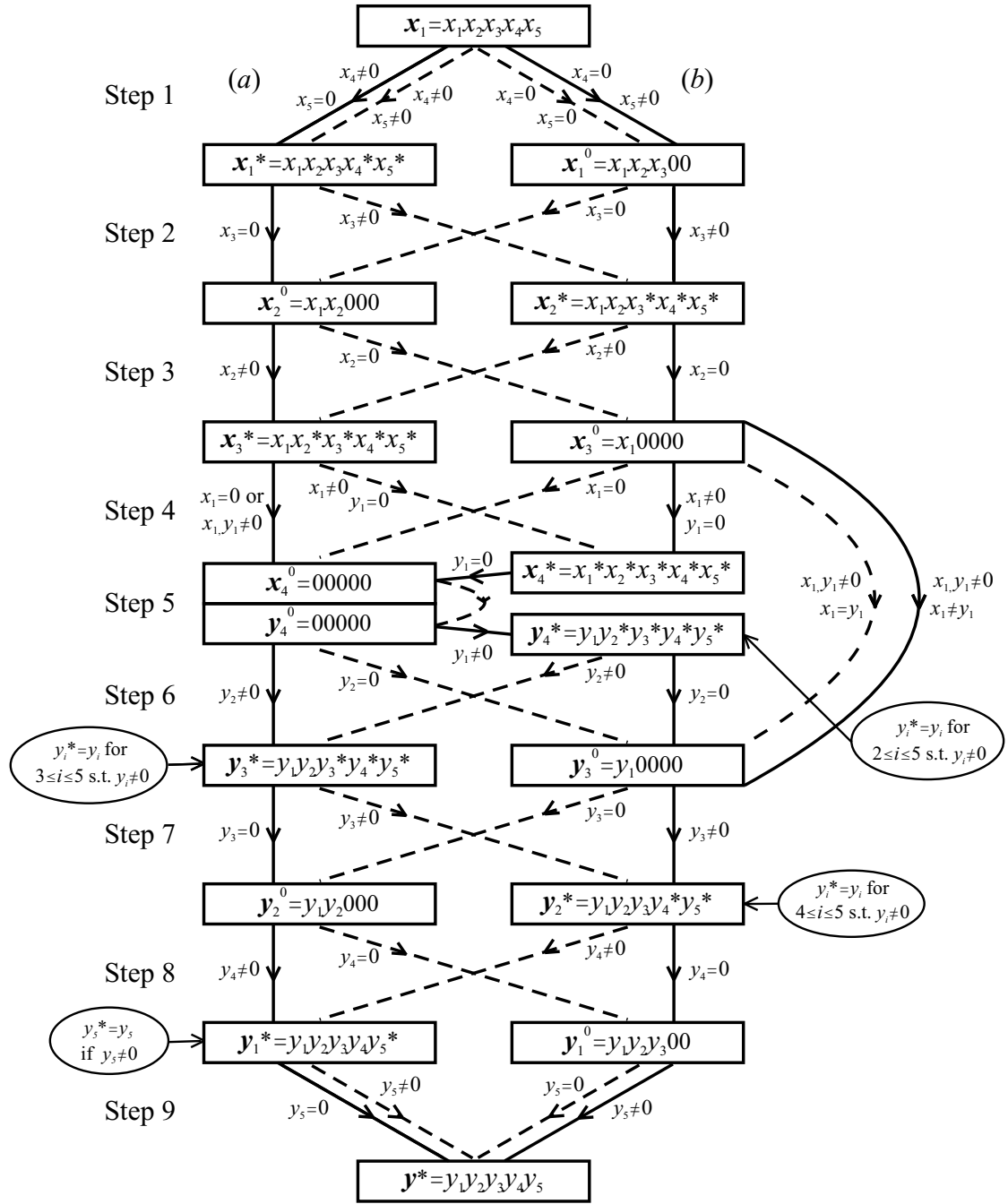

Figure 2. A routing algorithm in $H_{n,5}$.

are already there (that is, identical vertices). Note that, as commented above, all the paths go through the root \mathbf{r} , excepting in the case of Step $k-1$ (b2). Notice also that, in fact, we can assume that \mathbf{x} and \mathbf{y} have no common prefix, so that $x_1 \neq y_1$. Otherwise, if $\mathbf{x} = \alpha x_{i+1} x_{i+2} \dots x_k$ and $\mathbf{y} = \alpha y_{i+1} y_{i+2} \dots y_k$, denoted $\alpha = \mathbf{x} \cap \mathbf{y}$ and $i = |\alpha| > 0$, we are in the subgraph $H_{n,k-i}^\alpha$ (by property (c) in Subsection 2.2) and, hence, we can apply the routing algorithm to the vertices $\mathbf{x}' = x_{i+1} x_{i+2} \dots x_k$ and $\mathbf{y}' = y_{i+1} y_{i+2} \dots y_k$ of $H_{n,k-i}$.

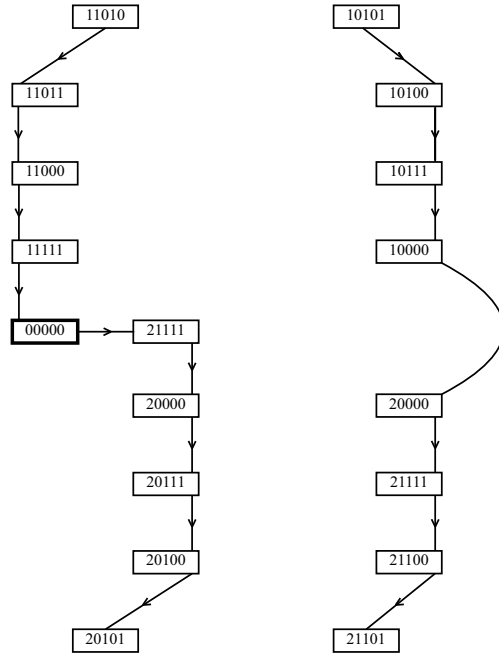

Figure 3. Case (i): A routing example in $H_{n,5}$ when $x_1, y_1 \neq 0$.

Examples of the routings obtained in the three basic cases are shown in Fig. 3: (i) $x_1, y_1 \neq 0$; and Fig. 4: (ii) $x_1 = 0, y_1 \neq 0$; and (iii) $x_1 \neq 0, y_1 = 0$. In each case it has been supposed that the vertices \mathbf{x} and \mathbf{y} are such that the path joining them has maximum length or number of edges (continuous lines). Note that, depending on the label of \mathbf{x} , the first part of the path goes either on the left (starting with Step 1(a)) or on the right (starting with Step 1(b)). Here, it is also worth noting that that the vertices and paths of cases (ii) and (iii) are conjugate and symmetrical, respectively, of each other.

3.2 Radius and Diameter

First, we introduce some notation concerning $H_{n,k}$, which is useful to find its metric parameters. Let $\partial_k(\mathbf{x}, \mathbf{y})$ denote the distance between vertices $\mathbf{x}, \mathbf{y} \in V_{n,k}$ in $H_{n,k}$; and $\partial_k(\mathbf{x}, U) := \min_{\mathbf{u} \in U} \{\partial(\mathbf{x}, \mathbf{u})\}$. Let $\mathbf{r}^\alpha = 00\dots 0$ be the root vertex of $H_{n,k-1}^\alpha$, $\alpha \in \mathbb{Z}_n$ (as stated before, \mathbf{r} stands for the root vertex of $H_{n,k}$). Let P and P^α , $\alpha \in \mathbb{Z}_n$, denote the set of peripheral vertices of $H_{n,k}$ and $H_{n,k-1}^\alpha$, respectively.

The following results on the metric parameters of $H_{n,k}$ are direct consequence of the proposed routing algorithm.

Proposition 3.1 *Let $r_k, \text{ecc}_k(\mathbf{r}), D_k$ denote, respectively, the radius, the eccentricity of the root \mathbf{r} , and the diameter of $H_{n,k}$. Then,*

- (a) $r_k = \text{ecc}(\mathbf{r}) = k$.
- (b) $D_k = 2k - 1$.

Then, from the result on the diameter and property (c) in Subsection 2.2, we have

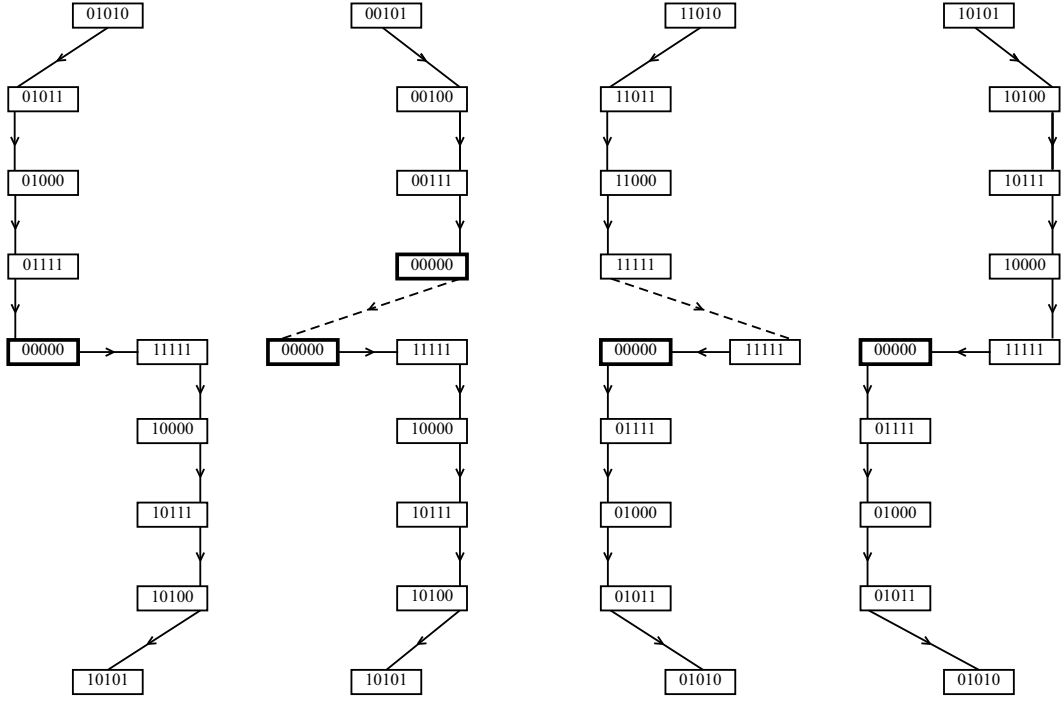

Figure 4. Cases (ii) and (iii): A routing algorithm in $H_{n,5}$ when $x_1 = 0$, $y_1 \neq 0$ and $x_1 \neq 0$, $y_1 = 0$.

that the distance between two vertices \mathbf{x} , \mathbf{y} of $H_{n,k}$, with maximum common prefix $|\mathbf{x} \cap \mathbf{y}|$, satisfies

$$\partial(\mathbf{x}, \mathbf{y}) \leq 2|\mathbf{x} \cap \mathbf{y}| - 1.$$

Alternatively, we can give recursive proofs of these results. Indeed, let us consider the case of the diameter. With this aim, we first give the following result which follows from the recursive definition of $H_{n,k}$:

Lemma 3.2 *Let \mathbf{x}, \mathbf{y} be two vertices in $H_{n,k}$, $k > 1$. Then, depending on the sub-graphs $H_{n,k-1}$ where such vertices belong to, we are in one of the following three cases:*

(a) *If $\mathbf{x}, \mathbf{y} \in \alpha V_{n,k-1}$ for some $\alpha \in \mathbb{Z}_n$; that is, $\mathbf{x} = \alpha \mathbf{x}'$ and $\mathbf{y} = \alpha \mathbf{y}'$, then,*

$$\partial_k(\mathbf{x}, \mathbf{y}) = \partial_{k-1}(\mathbf{x}', \mathbf{y}').$$

(b) *If $\mathbf{x} \in 0V_{n,k-1}$ and $\mathbf{y} \in \alpha V_{n,k-1}$ for some $\alpha \in \mathbb{Z}_n^*$; that is $\mathbf{x} = 0\mathbf{x}'$, $\mathbf{y} = \alpha \mathbf{y}'$, then,*

$$\partial_k(\mathbf{x}, \mathbf{y}) = \partial_{k-1}(\mathbf{x}', \mathbf{r}^0) + 1 + \partial_{k-1}(\mathbf{y}', P^\alpha).$$

(c) *If $\mathbf{x} \in \alpha V_{n,k-1}$ and $\mathbf{y} \in \beta V_{n,k-1}$ for some $\alpha, \beta \in \mathbb{Z}_n^*$, $\alpha \neq \beta$; that is $\mathbf{x} = \alpha \mathbf{x}'$, $\mathbf{y} = \beta \mathbf{y}'$, then,*

$$\partial_k(\mathbf{x}, \mathbf{y}) = \min\{\partial_{k-1}(\mathbf{x}', P^\alpha) + 2 + \partial_{k-1}(\mathbf{y}', P^\beta), \partial_{k-1}(\mathbf{x}', \mathbf{r}^\alpha) + 1 + \partial_{k-1}(\mathbf{r}^\beta, \mathbf{y}')\}.$$

Lemma 3.3 For any vertex \mathbf{x} in $H_{n,k}$ we have:

$$\partial_k(\mathbf{x}, \mathbf{r}) \leq \begin{cases} k-1 & \text{if } \mathbf{x} = 0\mathbf{x}', \\ k & \text{otherwise,} \end{cases} \quad \text{and} \quad \partial_k(\mathbf{x}, P) \leq \begin{cases} k & \text{if } \mathbf{x} = 0\mathbf{x}', \\ k-1 & \text{otherwise.} \end{cases}$$

Proof. By induction on k .

Case $k = 1$: If $\mathbf{x} = \mathbf{0} = \mathbf{r}$, then $\partial_1(\mathbf{x}, \mathbf{r}^0) = 0$ and $\partial_1(\mathbf{x}, P) = 1$. Otherwise, $\mathbf{x} \in P = \mathbb{Z}_n^*$, and then $\partial_1(\mathbf{x}, \mathbf{r}) = 1$ and $\partial_1(\mathbf{x}, P) = 0$.

Case $k > 1$: We observe that, from the recursive definition of $H_{n,k}$,

$$\partial_k(\mathbf{x}, \mathbf{r}) = \begin{cases} \partial_{k-1}(\mathbf{x}', \mathbf{r}^0) & \text{if } \mathbf{x} = 0\mathbf{x}', \\ \partial_{k-1}(\mathbf{x}', P^\alpha) + 1 & \text{if } \mathbf{x} = \alpha\mathbf{x}', \alpha \neq 0, \end{cases}$$

and

$$\partial_k(\mathbf{x}, P) = \begin{cases} \partial_{k-1}(\mathbf{x}', \mathbf{r}^0) + 1 & \text{if } \mathbf{x} = 0\mathbf{x}', \\ \partial_{k-1}(\mathbf{x}', P^\alpha) & \text{if } \mathbf{x} = \alpha\mathbf{x}', \alpha \neq 0. \end{cases}$$

Then, by the induction hypothesis, the lemma holds. \square

In the next result, $\mathbf{z}^{01} = 0101\dots$ and $\mathbf{z}^{10} = 1010\dots$ denote any vertex $x_1x_2\dots x_i\dots$ of $H_{n,k}$ or $H_{n,k-1}$, where $x_i \equiv i+1 \pmod{2}$ and $x_i \equiv i \pmod{2}$, respectively.

Lemma 3.4 In $H_{n,k}$ we have the following distances:

- (a) $\partial_k(\mathbf{z}^{01}, \mathbf{r}) = \partial_k(\mathbf{z}^{10}, P) = k-1$,
- (b) $\partial_k(\mathbf{z}^{10}, \mathbf{r}) = \partial_k(\mathbf{z}^{01}, P) = k$.

Proof. By induction on k .

Case $k = 1$: $H_{n,k}$ is the complete graph K_n and the result clearly holds.

Case $k > 1$: From Lemma 3.2 we have:

- (a) $\partial_k(\mathbf{z}^{01}, \mathbf{r}) = \partial_{k-1}(\mathbf{z}^{10}, \mathbf{r}^0) = k-1$,
 $\partial_k(\mathbf{z}^{10}, P) = \partial_{k-1}(\mathbf{z}^{01}, P^0) = k-1$;
- (b) $\partial_k(\mathbf{z}^{10}, \mathbf{r}) = \partial_{k-1}(\mathbf{z}^{01}, P^1) + 1 = k$,
 $\partial_k(\mathbf{z}^{01}, P) = \partial_{k-1}(\mathbf{z}^{10}, \mathbf{r}^0) + 1 = k-1+1 = k$.

\square

Now we can give the result about the diameter of $H_{n,k}$:

Proposition 3.5 The diameter of $H_{n,k}$ is $D_k = 2k-1$.

Proof. First we prove by induction on k that, for any given pair of vertices of $H_{n,k}$, \mathbf{x} and \mathbf{y} , we have $\partial_k(\mathbf{x}, \mathbf{y}) \leq 2k-1$.

Case $k = 1$: The result trivially holds since $H_{n,1} = K_n$ and $D_1 = 1$.

Case $k > 1$: Considering the three cases of Lemma 3.2 and by using the induction hypothesis, we have:

(a) If $\mathbf{x}, \mathbf{y} \in \alpha V_{n,k-1}$ for some $\alpha \in \mathbb{Z}_n$, then,

$$\partial_k(\mathbf{x}, \mathbf{y}) = \partial_{k-1}(\mathbf{x}', \mathbf{y}') \leq 2(k-1) - 1 = 2k - 3 < 2k - 1.$$

(b) If $\mathbf{x} \in 0V_{n,k}$ and $\mathbf{y} \in \alpha V_{n,k-1}$ for some $\alpha \in \mathbb{Z}_n^*$, then,

$$\partial_k(\mathbf{x}, \mathbf{y}) = \partial_{k-1}(\mathbf{x}', \mathbf{r}^0) + 1 + \partial_{k-1}(\mathbf{y}', P^\alpha) \leq 2(k-1) + 1 = 2k - 1$$

since, by Lemma 3.3, $\partial_{k-1}(\mathbf{x}', \mathbf{r}^0) \leq k-1$ and $\partial_{k-1}(\mathbf{y}', P^\alpha) \leq k-1$.

(c) If $\mathbf{x} \in \alpha V_{n,k}$ and $\mathbf{y} \in \beta V_{n,k-1}$ for some $\alpha, \beta \in \mathbb{Z}_n^*$, $\alpha \neq \beta$, then,

$$\begin{aligned} \partial_k(\mathbf{x}, \mathbf{y}) &= \min\{\partial_{k-1}(\mathbf{x}', P^\alpha) + 2 + \partial_{k-1}(\mathbf{y}', P^\beta), \partial_{k-1}(\mathbf{x}', \mathbf{r}^\alpha) + 1 + \partial_{k-1}(\mathbf{r}^\beta, \mathbf{y}')\} \\ &\leq 2(k-1) + 1 = 2k - 1 \end{aligned}$$

since, by Lemma 3.4, $\partial_{k-1}(\mathbf{x}', \mathbf{r}^\alpha) \leq k-1$ and $\partial_{k-1}(\mathbf{r}^\beta, \mathbf{y}') \leq k-1$.

Now, we have to prove that there exist two vertices in $H_{n,k}$ at distance exactly $2k-1$. Let $\mathbf{x} = \mathbf{z}^{01}$ and $\mathbf{y} = \mathbf{z}^{10}$. It follows from Lemmas 3.2 and 3.4 that $\partial_k(\mathbf{x}, \mathbf{y}) = 2k-1$ (see Fig. 4, case (ii) on the left). This completes the proof. \square

Note that the diameter scales logarithmically with the order $N = |V_{n,k}| = n^k$, since $D_k = \frac{2}{\log n} \log N - 1$. This property, together with the high value of the clustering coefficient (see next section), shows that this is a small-world network.

4 Degree and clustering distribution

In this section we study the degree and clustering distributions of the graph $H_{n,k}$. From the definition of the graph, the degree distribution is obtained straightforwardly.

Proposition 4.1 *The vertex degree distribution in $H_{n,k}$ is as follows:*

(a) *The root vertex \mathbf{r} of $H_{n,k}$ has degree*

$$\delta(\mathbf{r}) = \frac{(n-1)^{k+1} - (n-1)}{n-2}.$$

(b) *The degree of the root vertex \mathbf{r}_{k-i}^α of each of the $(n-1)n^{i-1}$ subgraphs $H_{n,k-i}^\alpha$, with $i = 1, 2, \dots, k-1$, $\alpha = \alpha_1\alpha_2 \dots \alpha_i \in \mathbb{Z}_n^i$ and $\alpha_i \neq 0$, is*

$$\delta(\mathbf{r}_{k-i}^\alpha) = \frac{(n-1)^{k-i+1} - (n-1)}{n-2} + (n-2).$$

(c) *The degree of the $(n-1)^k$ peripheral vertices \mathbf{p} of $H_{n,k}$ is*

$$\delta(\mathbf{p}) = n + k - 2.$$

(d) The degree of the $(n-1)^{k-i}n^{i-1}$ peripheral vertices \mathbf{p}_{k-i}^α of the subgraphs $H_{n,k-i}^\alpha$, with $i = 1, 2, \dots, k-1$, $\alpha = \alpha_1\alpha_2 \dots \alpha_i \in \mathbb{Z}_n^i$ and $\alpha_i \neq 0$, is

$$\delta(\mathbf{p}_{k-i}^\alpha) = n + k - i - 2.$$

Proof. (a) By the adjacency conditions (3) and (4), the root of $H_{n,k}$ has degree

$$\delta(\mathbf{r}) = \sum_{i=1}^k (n-1)^i = \frac{(n-1)^{k+1} - (n-1)}{n-2}.$$

(b) The root of the subgraph $H_{n,k-i}^\alpha$, $1 \leq i \leq k-1$, $\alpha_i \neq 0$, is adjacent, by (a), to $\frac{(n-1)^{k-i+1} - n + 1}{n-2}$ vertices belonging to the same subgraph, and also, by (5), to $n-2$ vertices which are the other roots “at the same level”.

(c) Each peripheral vertex of $H_{n,k}$ is adjacent, by (3), to $n-1$ vertices and, by (4), to $k-1$ vertices (which are roots of other subgraphs).

(d) Each peripheral vertex of $H_{n,k-i}^\alpha$, $1 \leq i \leq k-1$, $\alpha_i \neq 0$, is adjacent, by (3), to $n-1$ vertices (of the subgraph isomorphic to K_n) and, by (4), to $k-i$ vertices (roots of other subgraphs). \square

The above results on the degree distribution of $H_{n,k}$ are summarized in Table 1. Note that, from such a distribution, we can obtain again Proposition 2.2 since the number of edges can be computed from

$$2|E_{n,k}| = \delta(\mathbf{r}) + \sum_{i=1}^{k-1} (n-1)n^{i-1}\delta(\mathbf{r}_{k-i}^\alpha) + (n-1)^k\delta(\mathbf{p}) + \sum_{i=1}^{k-1} (n-1)^{k-i}n^{i-1}\delta(\mathbf{p}_{k-i}^\alpha),$$

which yields (7). Moreover, using such a result, the average degree and its asymptotic behavior, when $k \rightarrow \infty$, turn out to be

$$\bar{\delta} = \frac{2|E_{n,k}|}{|V_{n,k}|} = \frac{3n^{k+1} - 4n^k - 2(n-1)^{k+1} - n + 2}{n^k} \sim 3n - 4.$$

From the degree distribution and for large k we see that the number of vertices with a given degree z , $N_{n,k}(z)$, decreases as a power of the degree z and therefore the graph is scale-free [3,6,8]. As the degree distribution of the graph is discrete, to relate the exponent of this discrete degree distribution to the standard γ exponent of a continuous degree distribution for random scale free networks we use a cumulative distribution

$$P_{cum}(z) \equiv \sum_{z' \geq z} |N_{n,k}(z')| / |N_{n,k}(z)| \sim z^{1-\gamma},$$

where z and z' are points of the discrete degree spectrum. When $z = \frac{(n-1)^{k-i+1} - n + 2}{n-2}$, there are exactly $(n-1)n^{i-1}$ vertices with degree z . The number of vertices with this or a higher degree is

$$(n-1)n^{i-1} + \dots + (n-1)n + (n-1) + 1 = 1 + (n-1) \sum_{j=0}^{i-1} n^j = n^i.$$

Then, we have $z^{1-\gamma} = n^i/n^k = n^{i-k}$. Therefore, for large k , $((n-1)^{k-i})^{1-\gamma} \sim n^{i-k}$ and

$$\gamma \sim 1 + \frac{\log n}{\log(n-1)}.$$

For $n = 5$ this gives the same value of γ as in the case of the hierarchical network introduced in [17]. This network can be obtained from $H_{5,k}$ by deleting the edges which join the roots of $H_{5,k-i}^j$, $j \neq 0$, $1 \leq i \leq k-2$.

Table 1
Degree and clustering distribution for $H_{n,k}$

Vertex class	Num. vertices	Degree	Clustering
$H_{n,k}$ root	1	$\frac{(n-1)^{k+1} - (n-1)}{n-2}$	$\frac{(n-2)^2}{(n-1)^{k+1} - 2(n-1) + 1}$
$H_{n,k-i}^\alpha$ roots $i = 1, 2, \dots, k-1$, $\alpha \in \mathbb{Z}_n^i$, $\alpha_i \neq 0$	$(n-1)n^{i-1}$	$\frac{(n-1)^{k-i+1} - (n-1)}{n-2}$ $+n-2$	$\frac{(n-2)^2}{(n-1)^{k-i+1} + (n-1)^2 - 3(n-1) + 1}$
$H_{n,k}$ peripheral	$(n-1)^k$	$n+k-2$	$\frac{(n-1)^2 + (2k-3)(n-1) + 2 - 2k}{(n+k-2)(n+k-3)}$
$H_{n,k-i}^\alpha$ peripheral $i = 1, 2, \dots, k-1$, $\alpha \in \mathbb{Z}_n^i$, $\alpha_i \neq 0$	$(n-1)^{k-i}n^{i-1}$	$n+k-i-2$	$\frac{(n-1)^2 + (2k-2i-3)(n-1) + 2 + 2i - 2k}{(n+k-i-2)(n+k-i-3)}$

Next we find the clustering distribution of the vertices of $H_{n,k}$. The clustering coefficient of a graph G measures its “connectedness” and is another parameter used to characterize small-world and scale-free networks. The clustering coefficient of a vertex was introduced in [21] to quantify this concept: For each vertex $v \in V = V(G)$ with degree $\delta_v = |\Gamma(v)|$, its *clustering* $c(v)$ is defined as the fraction of the $\binom{\delta_v}{2}$ possible edges among the neighbors of v that are present in G . More precisely, if $\epsilon_v = \|\langle \Gamma(v) \rangle\|$ is the number of edges between the δ_v vertices adjacent to vertex v , its clustering coefficient is

$$c(v) = \frac{2\epsilon_v}{\delta_v(\delta_v - 1)}, \quad (13)$$

whereas the *clustering coefficient* of G , denoted by $c(G)$, is the average of $c(v)$ over all nodes v of G :

$$c(G) = \frac{1}{|V|} \sum_{v \in V} c(v). \quad (14)$$

Another definition of *clustering coefficient* of G was given in [15] as

$$c'(G) = \frac{3T(G)}{\tau(G)} \quad (15)$$

where $\tau(G)$ and $T(G)$ are, respectively, the number of *triangles* (subgraphs isomorphic to K_3) and the number of *triples* (subgraphs isomorphic to a path on 3 vertices) of G . A triple at a vertex v is a 3-path with central vertex v . Thus the number of triples at v is

$$\tau(v) = \binom{\delta_v}{2} = \frac{\delta_v(\delta_v - 1)}{2}. \quad (16)$$

The total number of triples of G is denoted by $\tau(G) = \sum_{v \in V} \tau(v)$. Using these parameters, note that the clustering coefficient of a vertex v can also be written as $c(v) = \frac{T(v)}{\tau(v)}$, where $T(v) = \binom{\delta_v}{2}$ is the number of triangles of G which contain vertex v . From this result, we get that $c(G) = c'(G)$ if, and only if,

$$|V| = \frac{\sum_{v \in V} \tau(v)}{\sum_{v \in V} T(v)} \sum_{v \in V} \frac{T(v)}{\tau(v)}.$$

This is true for regular graphs or for graphs such that all vertices have the same clustering coefficient. In fact, $c'(G)$ was already known in the context of social networks as *transitivity coefficient*.

We first compute the clustering coefficient and then the transitivity coefficient.

Proposition 4.2 *The clustering distribution of $H_{n,k}$ is the following:*

(a) *The root \mathbf{r} of $H_{n,k}$ has clustering*

$$c(\mathbf{r}) = \frac{(n-2)^2}{(n-1)^{k+1} - 2n + 3}.$$

(b) *The clustering of the root vertex \mathbf{r}_{k-i}^α of each of the $(n-1)n^{i-1}$ subgraphs $H_{n,k-i}^\alpha$, with $i = 1, 2, \dots, k-1$, $\alpha = \alpha_1\alpha_2 \dots \alpha_i \in \mathbb{Z}_n^i$ and $\alpha_i \neq 0$, is*

$$c(\mathbf{r}_{k-i}^\alpha) = \frac{(n-2)^2}{(n-1)n^{k-i+1} + (n-1)^2 - 3n + 4}.$$

(c) *The clustering of the $(n-1)^k$ peripheral vertices \mathbf{p} of $H_{n,k}$ is*

$$c(\mathbf{p}) = \frac{(n-1)^2 + (2k-3)(n-1) + 2 - 2k}{(n+k-2)(n+k-3)}.$$

(d) *The clustering of the $(n-1)^{k-i}n^{i-1}$ peripheral vertices \mathbf{p}_{k-i}^α of the subgraphs $H_{n,k-i}^\alpha$, with $i = 1, 2, \dots, k-1$, $\alpha = \alpha_1\alpha_2 \dots \alpha_i \in \mathbb{Z}_n^i$ and $\alpha_i \neq 0$ is*

$$c(\mathbf{p}_{k-i}^\alpha) = \frac{(n-1)^2 + (2k-2i-3)(n-1) + 2 + 2i - 2k}{(n+k-i-2)(n+k-i-3)}.$$

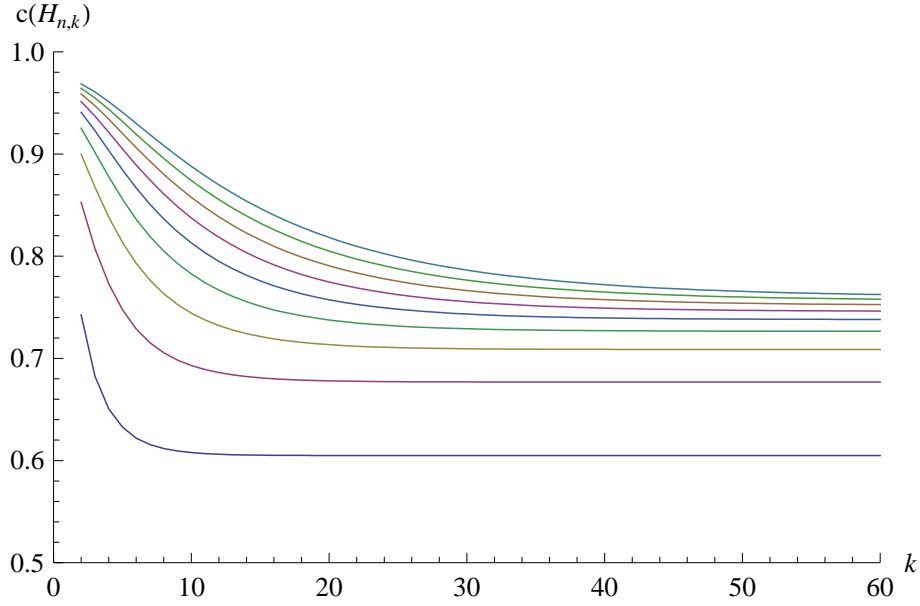

Figure 5. The clustering coefficient of $H_{n,k}$ for $n = 4, 6, \dots, 20$.

Proof. We prove only three of the cases, as the proof of the other is similar.

- (a) As the root of $H_{n,k}$ is adjacent to $\sum_{i=1}^k (n-1)^i$ vertices which have degree $n-2$, its clustering is

$$c(\mathbf{r}) = \frac{\frac{n-2}{2} \frac{(n-1)^{k+1} - n + 1}{n-2}}{\frac{1}{2} \frac{(n-1)^{k+1} - n + 1}{n-2} \left(\frac{(n-1)^{k+1} - n + 1}{n-2} - 1 \right)} = \frac{(n-2)^2}{(n-1)^{k+1} - 2n + 3}.$$

- (b) The roots of $H_{n,k-i}^\alpha$ ($i = 1, 2, \dots, k-1, \alpha_i \neq 0$) have clustering

$$\begin{aligned} c(\mathbf{r}_{k-i}^\alpha) &= \frac{\frac{n-2}{2} \frac{(n-1)^{k-i+1} - n + 1}{n-2} + \frac{(n-2)(n-3)}{2}}{\frac{1}{2} \left(\frac{(n-1)^{k-i+1} - n + 1}{n-2} + n - 2 \right) \left(\frac{(n-1)^{k-i+1} - n + 1}{n-2} + n - 3 \right)} \\ &= \frac{(n-2)^2}{(n-1)^{k-i+1} + (n-1)^2 - 3n + 4}. \end{aligned}$$

- (d) The clustering of the peripheral vertices of $H_{n,k-i}^\alpha$ ($i = 1, 2, \dots, k-1, \alpha_i \neq 0$), is

$$\begin{aligned} c(\mathbf{p}_{k-i}^\alpha) &= \frac{\frac{(n-1)(n-2)}{2} + (n-2)(k-i-1)}{\frac{1}{2}(n+k-i-2)(n+k-i-3)} \\ &= \frac{(n-1)^2 + (2k-2i-3)(n-1) + 2 + 2i - 2k}{(n+k-i-2)(n+k-i-3)}. \end{aligned}$$

In particular, note that for $i = k-1$, the peripheral vertices of $H_{n,1}^\alpha$, $\alpha \neq 0$, have clustering $\frac{(n-1)^2 - n + 1}{(n-1)n} = 1$.

□

The above results on the clustering distribution are summarized in Table 1. From these results we can compute the clustering coefficient of $H_{n,k}$, which is shown in

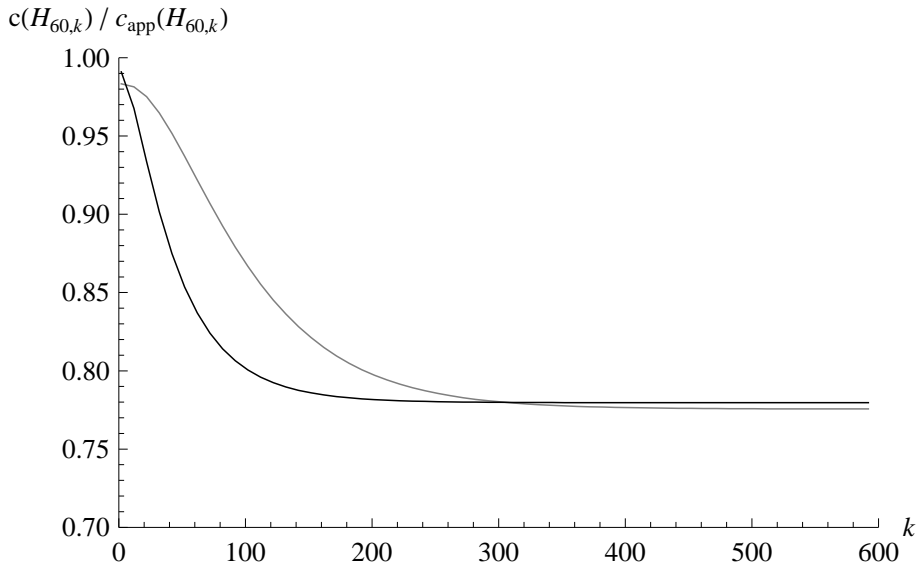

Figure 6. Comparison between the exact value of the clustering for $H_{60,k}$ (black line) and the asymptotic approximation (grey line).

Fig. 5. The clustering coefficient tend to 1 for large n .

For each degree, the clustering of the corresponding vertices is inversely proportional to it. Then, the clustering distribution verifies $c(z) \sim z^{-1}$. In [4], this is considered the most important signature of hierarchical modularity. However, another relevant characteristic of the clustering of $H_{n,k}$ is that, for k large enough, it has an almost constant value with k . More precisely, for large n , it tends very quickly to a constant value as $k \rightarrow \infty$, which is

$$c(H_{n,k}) \sim c_{app}(H_{n,k}) = 1 - \frac{1}{n} - \frac{1}{n} \sum_{i=1}^k \left(1 - \frac{1}{n}\right)^i \left(\frac{i}{n+i}\right)^2.$$

See Fig. 6. This value corresponds to the contribution of the peripheral vertices of $H_{n,k-i}^{\alpha}$ ($i = 1, 2, \dots, k-1$, $\alpha \in \mathbb{Z}_n^i$, $\alpha_i \neq 0$), as the contribution of the other vertices to the clustering of $H_{n,k}$ tends to zero as $n, k \rightarrow \infty$.

We think that this constant value for the clustering (which is independent of the order of the graph), together with the γ value of the power law distribution of the degrees, is also a good characterization of *modular* hierarchical networks. Observations in metabolic networks of different organism show that they are highly modular and have these properties, confirming the claim, see [4,18]

To find the transitivity coefficient we need to calculate the number of triangles and the number of triples of the graph.

Proposition 4.3 *The number $T_{n,k}$ of triangles of $H_{n,k}$ is:*

$$T_{n,k} = \frac{1}{2}(n-2) \left(1 - \frac{n}{3} - (n-1)^{k+1} + \frac{2}{3}n^k(2n-3)\right).$$

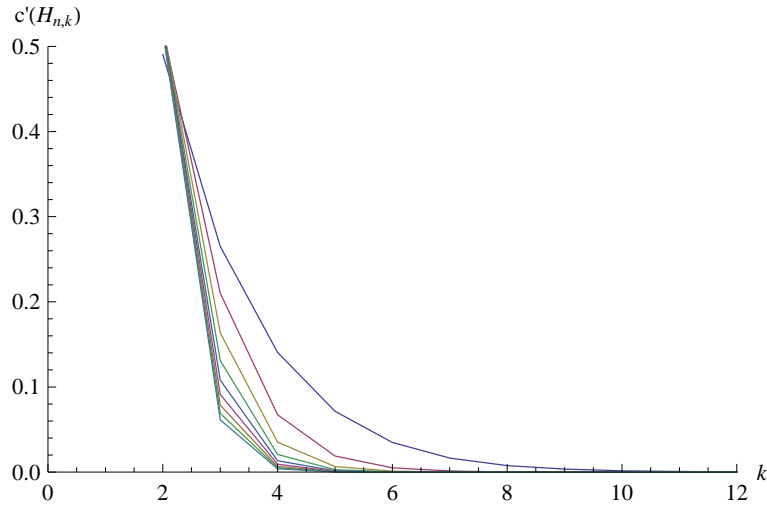

Figure 7. Transitivity coefficient of $H_{n,k}$ for $n = 4, 6, \dots, 20$

Proof.

When constructing $H_{n,k}$ from n copies of $H_{n-1,k}$, the adjacencies (1) and (2) introduce $(n-1)^{k-1} \binom{n-1}{2}$ and $\binom{n-1}{3}$ new triangles, respectively. Therefore,

$$T_{n,k} = nT_{n,k-1} + (n-1)^{k-1} \binom{n-1}{2} + \binom{n-1}{3}.$$

By applying recursively this formula and taking into account that $T_{n,1} = \binom{n}{3}$, we get the result. \square

Moreover, from the results of Proposition 4.1 (or Table 1) giving the number of vertices of each degree, we have the following result for the number of triples (we omit the obtained explicit formula, because of its length):

Proposition 4.4 *The number of triples, $\tau_{n,k}$, of $H_{n,k}$ is:*

$$\tau_{n,k} = \binom{\delta(\mathbf{r})}{2} + (n-1) \sum_{i=1}^{k-1} n^{i-1} \binom{\delta(\mathbf{r}_{k-i}^\alpha)}{2} + (n-1)^k \binom{\delta(\mathbf{p})}{2} + \sum_{i=1}^{k-1} (n-1)^{k-i} n^{i-1} \binom{\delta(\mathbf{p}_{k-i}^\alpha)}{2}.$$

Now the transitivity coefficient follows from the former two results and, as Fig. 7 shows, it tends quickly to zero as $k \rightarrow \infty$.

5 Conclusions

In this paper we have provided a family of graphs which generalize the hierarchical network introduced in [18], and combine a modular structure with a scale-free topology in order to model modular structures associated to living organisms, social organizations and technical systems. For the proposed graphs, a routing algorithm

is given. Moreover, we have calculated the radius, diameter, degree distribution and the clustering of such graphs, and we have seen that they are scale-free with a power law exponent which depends on the initial complete graph, that the clustering distribution $c(z)$ scales with the degree as z^{-1} , and the clustering coefficient does not depend on the graph order, as in many networks associated to real systems [4,17,18]. Finally, it is worthy mentioning that our definition can be generalized by taking the vertex set $\mathbb{Z}_{n_1} \times \mathbb{Z}_{n_2} \times \dots \times \mathbb{Z}_{n_k}$ (instead of \mathbb{Z}_n^k). In this case, all the results on the routing algorithm and the metric parameters still hold without changes.

Acknowledgment

Research supported by the Ministerio de Educación y Ciencia, Spain, and the European Regional Development Fund under projects MTM2005-08990-C02-01 and TEC2005-03575 and by the Catalan Research Council under project 2005SGR00256.

References

- [1] R. Albert and A.-L. Barabási, Statistical mechanics of complex networks, *Rev Mod Phys* 74 (2002), 47–97.
- [2] R. Albert, H. Jeong, and A.-L. Barabási, Diameter of the world wide web, *Nature* 401 (1999), 130–131.
- [3] A.-L. Barabási and R. Albert, Emergence of scaling in random networks, *Science* 286 (1999), 509–512.
- [4] A.-L. Barabási and Z.N. Oltvai, Network biology: Understanding the cell’s functional organization, *Nature Rev Genetics* 5 (2004), 101–113.
- [5] A.-L. Barabási, E. Ravasz, and T. Vicsek, Deterministic scale-free networks, *Physica A* 299 (2001) 559–564.
- [6] F. Comellas, G. Fertin, and A. Raspaud, Recursive graphs with small-world scale-free properties, *Phys Rev E* 69 (2004), 037104.
- [7] S.N. Dorogovtsev, A.V. Goltsev, and J.F.F. Mendes, Pseudofractal scale-free web, *Phys Rev E* 65 (2002), 066122.
- [8] S.N. Dorogovtsev and J.F.F. Mendes, Evolution of networks, *Adv Phys* 51 (2002), 1079–1187.
- [9] M. Faloutsos, P. Faloutsos, and C. Faloutsos, On power-law relationships of the internet topology. *Comput Commun Rev* 29 (1999), 251–260.
- [10] H. Jeong, B. Tombor, R. Albert, Z.N. Oltvai, and A.-L. Barabási, The large-scale organization of metabolic networks, *Nature* 407 (2000), 651–654.
- [11] H. Jeong, S. Mason, A.-L. Barabási, and Z.N. Oltvai, Lethality and centrality in protein networks, *Nature* 411 (2001) 41–42.

- [12] S. Jung, S. Kim, and B. Kahng, Geometric fractal growth model for scale-free networks, *Phys Rev E* 65 (2002), 056101.
- [13] M.E.J. Newman, The structure of scientific collaboration networks, *Proc Natl Acad Sci USA* 98 (2001), 404–409.
- [14] M.E.J. Newman, The structure and function of complex networks, *SIAM Rev* 45 (2003), 167–256.
- [15] M.E.J. Newman, D.J. Watts, and S.H. Strogatz. Random graph models of social networks, *Proc Natl Acad Sci USA* 99 (2002), 2566–2572.
- [16] J.D. Noh, Exact scaling properties of a hierarchical network model, *Phys Rev E* 67 (2003), 045103.
- [17] E. Ravasz and A.-L. Barabási, Hierarchical organization in complex networks, *Phys Rev E* 67 (2003), 026112.
- [18] E. Ravasz, A. L. Somera, D. A. Mongru, Z. N. Oltvai, and A.-L. Barabási, Hierarchical organization of modularity in metabolic networks, *Science* 297 (2002), 1551–1555.
- [19] C.M. Song, S. Havlin, and H.A. Makse, Self-similarity of complex networks *Nature* 433 (2005), 392–395.
- [20] R. V. Solé and S. Valverde, Information theory of complex networks: on evolution and architectural constraints, *Lecture Notes in Phys* 650 (2004), 189–207.
- [21] D.J. Watts and S.H. Strogatz, Collective dynamics of ‘small-world’ networks, *Nature* 393 (1998), 440–442.
- [22] S. Wuchty, E. Ravasz, and A.-L. Barabási, “The Architecture of Biological Networks”, *Complex Systems in Biomedicine*, T.S. Deisboeck, J. Yasha Kresh and T.B. Kepler (Editors), Kluwer Academic Publishing, New York, 2003.
- [23] Z.Z. Zhang, F. Comellas, G. Fertin, and L.L. Rong, High dimensional Apollonian networks, *J Phys A: Math Gen* 39 (2006), 1811–1818 .