

# The Neighbor-Locating-Chromatic Number of Pseudotrees

Liliana Alcon<sup>\*2,3</sup>, Marisa Gutierrez<sup>†2,3</sup>, Carmen Hernando<sup>‡1</sup>, Mercè Mora<sup>§1</sup>, and Ignacio M. Pelayo<sup>¶1</sup>

<sup>1</sup>Departament de Matemàtiques, Universitat Politècnica de Catalunya

<sup>2</sup>CMaLP, Universidad Nacional de La Plata

<sup>3</sup>CONICET, Argentina

## Abstract

A  $k$ -coloring of a graph  $G$  is a partition of the vertices of  $G$  into  $k$  independent sets, which are called *colors*. A  $k$ -coloring is *neighbor-locating* if any two vertices belonging to the same color can be distinguished from each other by the colors of their respective neighbors. The *neighbor-locating chromatic number*  $\chi_{NL}(G)$  is the minimum cardinality of a neighbor-locating coloring of  $G$ .

In this paper, we determine the neighbor-locating chromatic number of paths, cycles, fans and wheels. Moreover, a procedure to construct a neighbor-locating coloring of minimum cardinality for these families of graphs is given. We also obtain tight upper bounds on the order of trees and unicyclic graphs in terms of the neighbor-locating chromatic number. Further partial results for trees are also established.

*Key words:* coloring; location; neighbor-locating coloring; pseudotree.

## 1 Introduction

This work is devoted to studying a special type of vertex partitions, the so-called *neighbor-locating colorings*, within the family of graphs known as *pseudotrees*, that is to say, the set of all connected graphs containing at most one cycle.

There are mainly two types of location, metric location and neighbor location. Metric-locating sets (also known as resolving sets) were introduced simultaneously in [12, 15], meanwhile neighbor-locating sets were introduced in [16]. In [8], the notion of metric location

---

\*liliana@mate.unlp.edu.ar

†marisa@mate.unlp.edu.ar

‡Partially supp. by projects MTM2015-63791-R(MINECO/FEDER) and Gen.Cat. DGR2017SGR1336, carmen.hernando@upc.edu

§Partially supported by projects MTM2015-63791-R (MINECO/FEDER), Gen.Cat. DGR2017SGR1336 and H2020-MSCA-RISE project 734922-CONNECT, merce.mora@upc.edu

¶Partially supported by projects MINECO MTM2014-60127-P, ignacio.m.pelayo@upc.edu



This project has received funding from the European Union's Horizon 2020 research and innovation programme under the Marie Skłodowska-Curie grant agreement No 734922.

was brought to the ambit of vertex partitions, and in [6], there were first studied the so-called *locating colorings*, i.e., locating partitions (also known as resolving partitions) formed by independent sets. Both resolving partitions and locating colorings have been extensively studied since then. See e.g. [5, 9, 10, 11, 13, 14] and [2, 3, 4, 7, 17], respectively.

In [1], we started the study of neighbor-locating partitions formed by independent sets, which we named *neighbor-locating colorings*. More specifically, we considered vertex colorings such that any two vertices with the same color can be distinguished from each other by the colors of their respective neighbors. This paper continues that line of research focusing on the neighbor-locating colorings of pseudotrees, i.e., of paths, cycles, trees and unicyclic graphs.

## 1.1 Basic terminology

All the graphs considered in this paper are connected, undirected, simple and finite. The vertex set and the edge set of a graph  $G$  are denoted by  $V(G)$  and  $E(G)$ , respectively. We let  $n(G)$  be the order of  $G$ , i.e.  $n(G) = |V(G)|$ . The *neighborhood* of a vertex  $v \in V(G)$  is the set  $N(v) = \{w \in V(G) : vw \in E(G)\}$ . The *degree* of  $v$ , defined as the cardinality of  $N(v)$ , is denoted by  $\deg(v)$ . When  $\deg(v) = 1$ ,  $v$  is called a *leaf*. The *maximum degree*  $\Delta(G)$  of  $G$  is defined to be  $\Delta(G) = \max\{\deg(v) : v \in V(G)\}$ . The *distance* between two vertices  $v, w \in V(G)$  is denoted by  $d(v, w)$ . The *diameter* of  $G$  is  $\text{diam}(G) = \max\{d(v, w) : v, w \in V(G)\}$ .

Let  $\Pi = \{S_1, \dots, S_k\}$  be a  $k$ -partition of  $V(G)$ , i.e., a partition of the set of vertices of  $G$  into  $k$  subsets. If all the elements of  $\Pi$  are independent sets, then they are called *colors* and  $\Pi$  is said to be a *coloring* of  $G$  (also a  $k$ -coloring of  $G$ ). We say that a vertex  $v \in V(G)$  has color  $i$ , or that is colored with  $i$ , whenever  $v \in S_i$ .

Given a  $k$ -coloring  $\Pi = \{S_1, \dots, S_k\}$  of a graph  $G$  and a vertex  $v \in V(G)$ , the *color-degree* of  $v$  is defined to be the number of different colors of  $\Pi$  containing some vertex of  $N(v)$ , i.e.,  $|\{j : N(v) \cap S_j \neq \emptyset\}|$ .

## 1.2 Neighbor-locating colorings

A coloring  $\Pi = \{S_1, \dots, S_k\}$  of a graph  $G$  is called a *neighbor-locating coloring*, an *NL-coloring* for short, if for every pair of different vertices  $u, v$  belonging to the same color  $S_i$ , the set of colors of the neighborhood of  $u$  is different from the set of colors of the neighborhood of  $v$ , that is,

$$\{j : N(u) \cap S_j \neq \emptyset\} \neq \{j : N(v) \cap S_j \neq \emptyset\}.$$

The *neighbor-locating chromatic number*  $\chi_{NL}(G)$ , the *NLC-number* for short, is the minimum cardinality of an NL-coloring of  $G$ .

Both neighbor-locating colorings and the neighbor-locating chromatic number of a graph were introduced in [1]. As a straightforward consequence of these definitions the following remark is derived.

**Remark 1.** Let  $\Pi = \{S_1, \dots, S_k\}$  be a  $k$ -NL-coloring of a graph  $G$  order  $n$  and maximum degree  $\Delta$ . For every  $1 \leq i \leq k$ , there are at most  $\binom{k-1}{j}$  vertices in  $S_i$  of color-degree  $j$ , where

$$1 \leq j \leq k-1 \text{ and, consequently, } |S_i| \leq \sum_{j=1}^{\Delta} \binom{k-1}{j}.$$

**Theorem 2** ([1]). Let  $G$  be a non-trivial connected graph of order  $n(G) = n$  and maximum degree  $\Delta(G) = \Delta$  such that  $\chi_{NL}(G) = k$ . Then,

(1)  $n \leq k(2^{k-1} - 1)$ . Moreover, this bound is tight.

(2) If  $\Delta \leq k - 1$ , then  $n \leq k \sum_{j=1}^{\Delta} \binom{k-1}{j}$ .

To simplify the writing, given a  $k$ -NL-coloring of a graph  $G$  with maximum degree  $\Delta$ , we denote by  $a_j(k)$  the maximum number of vertices of color-degree  $j$  and by  $\ell(k)$ , the maximum number of vertices of color-degree 1 or 2, where  $k \geq 3$  and  $1 \leq j \leq \Delta$ . By Remark 1, we have:

- $a_1(k) = k \cdot (k - 1)$ ,  $a_2(k) = \frac{k \cdot (k - 1)(k - 2)}{2}$ .
- $\ell(k) = a_1(k) + a_2(k) = k \cdot \binom{k}{2} = \frac{k^3 - k^2}{2}$ .

The remaining part of this paper is organized as follows. In Section 2, the neighbor-locating chromatic number of paths and of cycles is determined. Section 4 deals with unicyclic graphs, providing a tight upper bound on the order of a unicyclic graph with a given fixed neighbor-locating chromatic number. In Section 5, the neighbor-locating colorings of trees is studied. Among other results, a tight upper bound on the order of a tree with a given fixed NLC-number. Finally, in Section 6, we summarize our results and pose some open problems.

## 2 Paths and Cycles

This section is devoted to determine the NLC-number of all paths and cycles, i.e., all graphs with maximum degree  $\Delta(G) = 2$ .

**Proposition 3.** *If  $G$  is a graph of order  $n$  and maximum degree  $\Delta(G) = 2$  such that  $\chi_{NL}(G) = k \geq 3$ , then  $n(G) \leq \ell(k)$ .*

*Proof.* Since all vertices have color-degree at most 2, we have  $n \leq a_1(k) + a_2(k) = \ell(k)$ .  $\square$

**Corollary 4.** *If  $G$  is either a path or a cycle such that  $n(G) > \ell(k - 1)$ , then  $\chi_{NL}(G) \geq k$ .*

*Proof.* This inequality directly follows from Proposition 3 taking into account that  $\ell$  is an increasing function.  $\square$

**Remark 5.** *Let  $\{S_1, \dots, S_k\}$  be a  $k$ -NL-coloring of a graph  $G$  of order  $n = \ell(k)$  and maximum degree  $\Delta(G) = 2$ . If  $k \geq 3$ , then for every  $i \in \{1, \dots, k\}$ :*

(1)  $|S_i| = \binom{k}{2}$ ;

(2) there are exactly  $\binom{k-1}{2}$  vertices in  $S_i$  of color-degree 2;

(3) there are exactly  $k - 1$  vertices in  $S_i$  of color-degree 1.

*Proof.* Since  $\Delta(G) = 2$ , by Remark 1 we have  $|S_i| \leq \binom{k-1}{1} + \binom{k-1}{2} = \binom{k}{2}$ , for every  $i \in \{1, \dots, k\}$ . If  $|S_i| < \binom{k}{2}$  for some  $i \in \{1, \dots, k\}$ , then  $n(G) = \sum_{j=1}^k |S_j| < k \binom{k}{2} = \ell(k)$ , a contradiction. Hence, (1) holds. Moreover, if, for some  $i \in \{1, \dots, k\}$ , the number of vertices of color-degree 2 is less than  $\binom{k-1}{2}$  or the number of vertices of color-degree 1 is less than  $k-1$ , then  $|S_i| < \binom{k-1}{1} + \binom{k-1}{2} = \binom{k}{2}$ , which contradicts (1).  $\square$

**Proposition 6.** *If  $k \geq 3$ , then  $\chi_{NL}(C_{\ell(k)-1}) \geq k+1$ .*

*Proof.* It is easy to check that  $\ell(k) - 1 = \frac{k^3 - k^2}{2} - 1 > \frac{(k-1)^3 - (k-1)^2}{2} = \ell(k-1)$ , if  $k \geq 3$ . Hence, by Corollary 4 we have  $\chi_{NL}(C_{\ell(k)-1}) \geq k$ .

Suppose that, on the contrary,  $\chi_{NL}(C_{\ell(k)-1}) = k$  and consider a  $k$ -NL-coloring  $\{S_1, \dots, S_k\}$  of  $C_{\ell(k)-1}$ . Similarly as argued in the proof of Remark 5, there must be exactly  $\binom{k}{2}$  vertices of all but one of the  $k$  colors, and  $\binom{k}{2} - 1$  vertices of the remaining color. We may assume without loss of generality that  $|S_k| = \binom{k}{2} - 1$  and  $|S_i| = \binom{k}{2}$ , whenever  $i \neq k$ . To attain this number of vertices, for each color  $i \in \{1, \dots, k-1\}$ , there must be a vertex of color-degree 1 in  $S_i$  with both neighbors in  $S_k$  and, for every  $j \neq i, k$ , there must be a vertex of color-degree 2 in  $S_i$  with a neighbor in  $S_k$  and the other in  $S_j$ . Besides, both neighbors of a vertex of  $S_k$  belong to  $S_1 \cup \dots \cup S_{k-1}$ . Hence, if we sum the number of neighbors colored with  $k$  for all the vertices belonging to  $S_1 \cup \dots \cup S_{k-1}$ , we count exactly twice each vertex of  $S_k$ . Therefore,  $2|S_k| = (k-1)(2 + (k-2)) = k(k-1)$ , contradicting that  $|S_k| = \binom{k}{2} - 1 = \frac{k(k-1)}{2} - 1$ .  $\square$

Next theorem establishes the NLC-number of paths and cycles of small order.

**Theorem 7.** *The values of the NLC-number for paths and cycles of order at most 9 are:*

- (1)  $\chi_{NL}(P_2) = 2$ .
- (2)  $\chi_{NL}(P_n) = 3$ , if  $3 \leq n \leq 9$ .
- (3)  $\chi_{NL}(C_n) = 3$ , if  $n \in \{3, 5, 7, 9\}$ .
- (4)  $\chi_{NL}(C_n) = 4$ , if  $n \in \{4, 6, 8\}$

*Proof.* Trivially,  $P_2$  is the only graph  $G$  with  $\chi_{NL}(G) = 2$ . According to Proposition 3, the order of a path or a cycle with NLC-number equal to 3 is at most 9. For  $P_n$  with  $3 \leq n \leq 9$  and for  $C_n$  with  $n \in \{3, 5, 7, 9\}$ , a 3-NL-coloring is displayed in Figure 1.

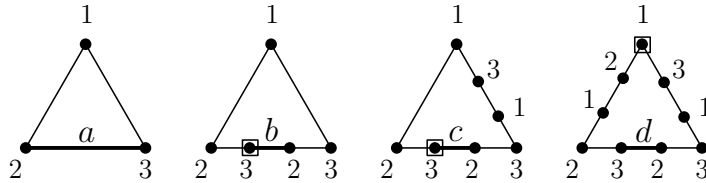

Figure 1: From left to right, a 3-NL-coloring of cycles  $C_3$ ,  $C_5$ ,  $C_7$  and  $C_9$ . A 3-NL-coloring of paths  $P_4$ ,  $P_6$  and  $P_8$  can be obtained by removing the squared vertices and a 3-NL-coloring of paths  $P_3$ ,  $P_5$ ,  $P_7$  and  $P_9$  can be obtained by removing the edges  $a$ ,  $b$ ,  $c$  and  $d$ , respectively.

Clearly,  $\chi_{NL}(C_4) = 4$  since, as was proved in [1], for every complete multipartite graph  $G$  of order  $n$ ,  $\chi_{NL}(G) = n$ .

An exhaustive analysis of all possible cases shows that  $\chi_{NL}(C_6) \geq 4$ . Clearly, a 4-NL-coloring for  $C_6$  can be obtained by inserting a vertex colored with 4 in any edge of the 3-NL-coloring given for  $C_5$  in Figure 1. Hence,  $\chi_{NL}(C_6) = 4$ .

By Proposition 6,  $\chi_{NL}(C_8) \geq 4$ . Clearly, a 4-NL-coloring for  $C_8$  can be obtained by inserting a vertex colored with 4 in any edge of the 3-NL-coloring given for  $C_7$  in Figure 1. Hence,  $\chi_{NL}(C_8) = 4$ .  $\square$

In what follows, several technical results are given. They are needed to prove Theorem 17, where the NLC-number of all paths and cycles of order greater than 9 is determined.

**Lemma 8.** *In any NL-coloring of the cycle  $C_n$ , every vertex of color-degree 1 has at least one neighbor of color-degree 2.*

*Proof.* Let  $x$  be a vertex of color-degree 1. In order to derive a contradiction, suppose that its two neighbors  $y$  and  $z$  have also color-degree 1. Then,  $y$  and  $z$  have the same color, and each one of them has its two neighbors with the same color, indeed the color of  $x$ . A contradiction in any NL-coloring.  $\square$

The following operations will be used to obtain NL-colorings of some cycles from NL-colorings of smaller cycles by inserting vertices of degree 2.

**Definition 9.** Consider a coloring (not necessarily neighbor-locating) of a cycle  $C_n$ . Let  $x$  and  $y$  be a pair of adjacent vertices colored with  $i$  and  $j$ , with  $i \neq j$ , respectively. The following operations produce a coloring of a cycle of order  $n + 1$  and  $n + 2$ , respectively.

(OP1) If  $x$  and  $y$  have color-degree 1, insert a new vertex  $z$  colored with  $h$ ,  $h \neq i, j$ , in the edge  $xy$  (see Figure 2, left).

(OP2) If  $x$  and  $y$  are vertices of color degree 2, insert two new vertices  $x'$  and  $y'$  in the edge  $xy$ , so that  $xx'$ ,  $x'y'$  and  $y'y$  are edges of the new cycle, and  $x'$  and  $y'$  are colored with  $j$  and  $i$ , respectively (see Figure 2, right).

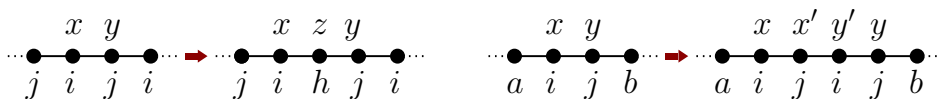

Figure 2: Illustrating Definition 9. Left,  $|\{i, j, h\}| = 3$  and right,  $|\{i, j, a, b\}| = 4$ .

Observe that the colors of vertices  $x$  and  $y$  are preserved with these operations. Operation (OP2) preserves also their color-degree and the set of colors of their neighbors. However, operation (OP1) changes the color-degree of  $x$  and  $y$  from 1 to 2. Besides, the vertex  $z$  added by operation (OP1) has color degree 2, meanwhile the vertices  $x'$  and  $y'$  added by operation (OP2) have color degree 1. Notice that the color, color-degree and set of colors of the neighborhood of any other vertex different from  $x, y, z$  when applying operation (OP1), and different from  $x, y, x', y'$ , when applying operation (OP2), remain unchanged.

The following type of NL-colorings will play an important role to construct NL-colorings of paths and cycles.

**Definition 10.** An NL-coloring is said to be 1-paired if every vertex of color-degree 1 has a neighbor of color-degree 1.

**Remark 11.** If a  $k$ -NL-coloring is 1-paired, then every vertex of color-degree 2 has at least one neighbor of color degree 2.

**Remark 12.** The 3-NL-coloring given in Figure 1 for the cycle  $C_9$  is 1-paired.

**Lemma 13.** Let  $k \geq 4$  be an integer. Then,

- (1) for every  $n \in \{\ell(k-1) + 1, \dots, \ell(k) - 2, \ell(k)\}$ , there is a 1-paired  $k$ -NL-coloring of  $C_n$ .
- (2) If  $n \neq a_2(k)$ , then there is a 1-paired  $k$ -NL-coloring of  $C_n$  containing (at least) a pair of adjacent vertices of color-degree 1.
- (3) If  $n = \ell(k)$ , then there is a 1-paired  $k$ -NL-coloring of  $C_n$  containing a sequence of 7 consecutive vertices colored with 1, 2, 1, 2, 3, 2, 3, respectively.

*Proof.* Let  $k \geq 4$ . We begin by proving that the stated result is true if there exists a 1-paired  $(k-1)$ -NL-coloring of  $C_{\ell(k-1)}$  (an example of the procedure described below is shown in Figure 3 for  $k = 4$ ).

Suppose that  $\{S_1, \dots, S_{k-1}\}$  is a 1-paired  $(k-1)$ -NL-coloring of  $C_{\ell(k-1)}$ . As a consequence of Remark 5, by the one hand, if  $i, j, h$  are different colors from  $\{1, \dots, k-1\}$ , then there must be a vertex in  $S_h$  of color-degree 2 with a neighbor in  $S_i$  and the other in  $S_j$ . On the other hand, for each pair of distinct colors  $i, j \in \{1, \dots, k-1\}$ , there must be a vertex in  $S_i$  of color-degree 1 with both neighbors in  $S_j$ . In this last case, since the coloring is 1-paired, one of these neighbors must have color-degree 1. Therefore, for each pair of distinct colors  $i, j \in \{1, \dots, k-1\}$ , there is a pair of adjacent vertices  $x \in S_i$  and  $y \in S_j$  of color-degree 1. By Lemma 8, these  $\binom{k-1}{2}$  pairs of adjacent vertices of color-degree 1 are pairwise disjoint.

For every one of the  $\binom{k-1}{2}$  pairs of adjacent vertices of color-degree 1 we can insert a new vertex colored with a new color  $k$  as described in (OP1). Note that in this way, we add at each step a new vertex of color-degree 2 to  $S_k$  (the set of vertices with the new color  $k$ ), and there is a pair of adjacent vertices of color-degree 1 that become vertices of color-degree 2. Besides, by construction, we have a  $k$ -NL-coloring at each step. Therefore, after  $\binom{k-1}{2}$  steps we obtain a  $k$ -NL-coloring of the cycle of order  $\ell(k-1) + \binom{k-1}{2} = a_2(k)$  such that there are no vertices of color-degree 1. Moreover, at every intermediate step we have a 1-paired  $k$ -NL-coloring of the corresponding cycle. In particular, we obtain 1-paired  $k$ -NL-colorings of  $C_{a_2(k)-1}$  and of  $C_{a_2(k)}$  such that for each unordered pair  $\{i, j\} \subseteq \{1, \dots, k\}$  there exists a pair of adjacent vertices  $x \in S_i$  and  $y \in S_j$  of color-degree 2. Besides, the 1-paired NL-coloring of  $C_{a_2(k)}$  has no vertices of color degree 1, while the 1-paired NL-coloring of  $C_{a_2(k)-1}$  has exactly one pair of adjacent vertices of color-degree 1.

Now, starting with the  $k$ -NL-coloring obtained for  $C_{a_2(k)}$ , choose an edge with endpoints of color-degree 2 in  $S_i$  and  $S_j$ , respectively, for every pair  $i, j$  of distinct colors of  $\{1, \dots, k\}$ . By successively applying (OP2) to the  $\binom{k}{2}$  edges chosen in this way, it is possible to add up to  $\binom{k}{2}$  pairs of adjacent vertices of color-degree 1 giving rise to a 1-paired coloring of  $C_n$ , whenever  $n$  has the same parity as  $a_2(k)$ , and  $a_2(k) \leq n \leq a_2(k) + 2\binom{k}{2} = \ell(k)$ .

We can proceed in a similar way starting with the 1-paired  $k$ -NL-coloring of  $C_{a_2(k)-1}$ . The difference with respect to the preceding case is that now we already have a pair of vertices of color-degree 1 that we may assume are colored with  $i'$  and  $j'$ , respectively, with their neighbors in  $S_{j'}$  and in  $S_{i'}$ , respectively. Hence, in order to have an NL-coloring at each step, we don't choose any edge with endpoints of color-degree 2 and colored with  $i'$  and  $j'$ . By successively applying (OP2) to the  $\binom{k}{2} - 1$  chosen edges, it is possible to add up to  $\binom{k}{2} - 1$  pairs of adjacent vertices of color-degree 1 obtaining a 1-paired coloring of  $C_n$ , whenever  $n$  has the same parity as  $a_2(k) - 1$ , and  $a_2(k) - 1 \leq n \leq a_2(k) - 1 + 2 \left( \binom{k}{2} - 1 \right) = \ell(k) - 2$ .

This procedure gives a 1-paired  $k$ -NL-coloring of  $C_n$ , whenever  $\ell(k-1) < n \leq \ell(k)$  and  $n \neq \ell(k) - 1$ . Moreover, by construction, the obtained 1-paired  $k$ -NL-coloring of  $C_n$  has at least a pair of adjacent vertices of color-degree 1, except for the case  $n = a_2(k)$ , that has no vertex of color-degree 1. The sequence of colors 1, 2, 1, 2, 3, 2, 3 can be obtained in the following way. Consider the edges incident to a vertex  $u \in S_2$  and with neighbors colored with 1 and 3 in  $C_{a_2(k)}$  (we know that it exists) and begin applying (OP2) to the edges incident to  $u$ .

Now we proceed to prove the stated result by induction. For  $k = 4$ , we have  $\ell(3) = 9$  and a 1-paired 3-NL-coloring of  $C_9$  is given in Figure 3. Hence, using the procedure described above, we have that the stated result is true for  $k = 4$ . Now let  $k > 4$ . By induction hypothesis, the stated result is true for  $k - 1$ , that is, there exists a 1-paired  $(k - 1)$ -NL-coloring of  $C_{\ell(k-1)}$  and we can proceed as described above to demonstrate the result for  $k$ .  $\square$

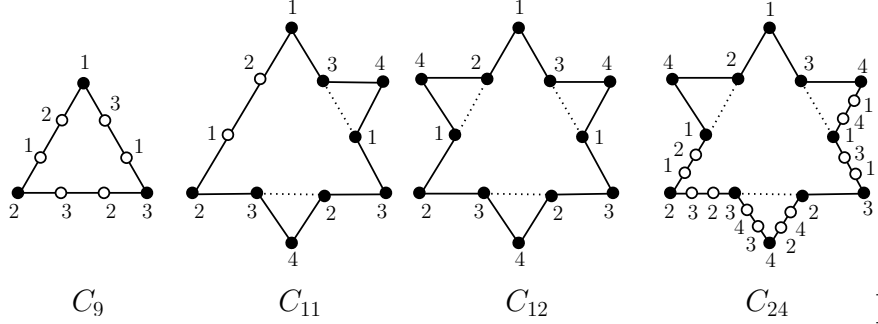

Figure 3: Obtaining a 4-NL-coloring from a 1-paired 3-NL-coloring of the cycle  $C_9$ . In white, the vertices of color-degree 1. Recall that  $\ell(3) = 9$ ,  $\ell(4) = 24$ ,  $a_2(4) - 1 = 11$  and  $a_2(4) = 12$ . Inserting vertices of color-degree 2 in some edges of  $C_9$ , we achieve 4-NL-colorings of  $C_n$ , whenever  $n \in \{10, 11, 12\}$ . Inserting pairs of white vertices in some edges of  $C_{11}$  and of  $C_{12}$  we achieve 4-NL-colorings of  $C_n$ , whenever  $n \in \{13, \dots, 24\} \setminus \{23\}$ .

**Lemma 14.** *Let  $k \geq 4$  be an integer. If there is a 1-paired  $k$ -NL-coloring of  $C_n$ , then there is a  $k$ -NL-coloring of  $P_n$ .*

*Proof.* Consider one of the 1-paired  $k$ -NL-colorings of  $C_n$  described to prove Lemma 13. For  $n \neq a_2(k)$ , it is enough to remove from the cycle any edge joining two adjacent vertices of color-degree 1. For  $n = a_2(k)$ , the removal of any edge  $xy$  gives rise to only two vertices,  $x$  and  $y$ , of color-degree 1, and the set of colors of the neighborhood of any other vertex is not modified. Hence, in any case, we have a  $k$ -NL-coloring of the path  $P_n$ .  $\square$

**Lemma 15.** *For every integer  $k \geq 4$ , there is a  $k$ -NL-coloring of the path  $P_{\ell(k)-1}$ .*

*Proof.* Consider the  $k$ -NL-coloring of the cycle  $C_{\ell(k)}$  containing the sequence of vertices colored with 1, 2, 1, 2, 3, 2, 3 described in Lemma 13. If we remove from the preceding sequence the vertex colored with 2 whose neighbors have colors 1 and 3, respectively, then we obtain a  $k$ -NL-coloring of  $P_{\ell(k)-1}$ .  $\square$

**Lemma 16.** *For every integer  $k \geq 4$ , there is a  $(k + 1)$ -NL-coloring of the cycle  $C_{\ell(k)-1}$ .*

*Proof.* Consider a  $k$ -NL-coloring of the cycle  $C_{\ell(k)-2}$ . Let  $x$  and  $y$  be adjacent vertices. Remove the edge  $xy$  and add a new vertex  $z$  adjacent to  $x$  and  $y$ . If  $z$  is colored with a new color  $k + 1$ , then we have a  $(k + 1)$ -NL-coloring of  $C_{\ell(k)-1}$ .  $\square$

As a consequence of Corollary 4 and Lemmas 13, 14, 15 and 16, we can determine the neighbor-locating chromatic number of graphs and cycles of order at least 4. Notice that the given proofs of these lemmas are constructive. Hence, it is possible to produce NL-colorings of minimum cardinality for all paths and cycles.

**Theorem 17.** *Let  $k, n$  be integers such that  $k \geq 4$  and  $\ell(k - 1) < n \leq \ell(k)$ . Then,*

- (1)  $\chi_{NL}(P_n) = k$ .
- (2)  $\chi_{NL}(C_n) = k$ , if  $n \neq \ell(k) - 1$ .
- (3)  $\chi_{NL}(C_n) = k + 1$ , if  $n = \ell(k) - 1$ .

### 3 Fans and Wheels

The graphs that are obtained by adding a new vertex adjacent to every vertex of either the path or the cycle of order  $n - 1$  are the *fan* and the *wheel* of order  $n$ , that are denoted by  $F_n$  and  $W_n$ , respectively. The preceding theorem allows us to determine the NLC-number of these graphs.

**Lemma 18.** *If  $G'$  is the graph obtained from a graph  $G$  by adding a new vertex adjacent to every vertex of  $G$ , then  $\chi_{NL}(G') = \chi_{NL}(G) + 1$ .*

*Proof.* Let  $\chi_{NL}(G) = k$ ,  $\chi_{NL}(G') = k'$  and let  $u$  be the vertex of  $G'$  adjacent to every vertex of  $G$ . Obviously,  $k' \leq k + 1$ , because a  $(k + 1)$ -NL-coloring of  $G'$  can be obtained from a  $k$ -NL-coloring of  $G$  by assigning a new color to vertex  $u$ . On the other hand, if we have a  $k'$ -NL-coloring  $\Pi'$  of  $G'$ , then the color assigned to  $u$  must be different from the color assigned to any vertex of  $G$ . Moreover, since every vertex of  $G$  is adjacent to  $u$ , the coloring  $\Pi'$  restricted to the vertices of  $G$  is a  $(k' - 1)$ -NL-coloring of  $G$ , implying that  $k \leq k' - 1$ . Hence,  $k' = k + 1$ .  $\square$

**Theorem 19.** *The NLC-number of fans and wheels of order  $n$ ,  $4 \leq n \leq 10$ , is:*

- (1)  $\chi_{NL}(F_n) = 4$ , if  $4 \leq n \leq 10$ .
- (2)  $\chi_{NL}(W_n) = 4$ , if  $n \in \{4, 6, 8, 10\}$ .
- (3)  $\chi_{NL}(W_n) = 5$ , if  $n \in \{5, 7, 9\}$

*Proof.* It is a direct consequence of Lemma 18 and Theorem 7.  $\square$



**Theorem 20.** *Let  $k, n$  be integers such that  $k \geq 4$  and  $\ell(k-1) + 1 < n \leq \ell(k) + 1$ . Then,*

- (1)  $\chi_{NL}(F_n) = k + 1$ .
- (2)  $\chi_{NL}(W_n) = k + 1$ , if  $n \neq \ell(k)$ .
- (3)  $\chi_{NL}(W_n) = k + 2$ , if  $n = \ell(k)$ .

*Proof.* It is a direct consequence of Lemma 18 and Theorem 17. □

Notice that NL-colorings of minimum cardinality for fans and wheels can be constructed from NL-colorings of paths and cycles, respectively, by assigning a new color to the added vertex.

## 4 Unicyclic graphs

A connected graph is called *unicyclic* if it contains precisely one cycle.

**Theorem 21.** *Let  $G$  be a unicyclic graph. If  $\chi_{NL}(G) = k \geq 3$ , then*

$$n(G) \leq 2a_1(k) + a_2(k) = \frac{1}{2}(k^3 + k^2 - 2k).$$

*Moreover, if the equality holds, then  $G$  has maximum degree 3, and it contains  $k(k-1)$  leaves,  $\frac{k(k-1)(k-2)}{2}$  vertices of degree 2, and  $k(k-1)$  vertices of degree 3.*

*Proof.* Let  $n$ ,  $n_1$ ,  $n_2$  and  $n_{\geq 3}$  be respectively the order, the number of leaves, the number of vertices of degree 2 and the number of vertices of degree at least 3 of  $G$ . On the one hand, we know that

$$n_1 + 2n_2 + \sum_{\deg(u) \geq 3} \deg(u) = \sum_{u \in V(G)} \deg(u) = 2|E(G)| = 2n = 2(n_1 + n_2 + n_{\geq 3}).$$

From here, we deduce that

$$n_1 = \sum_{\deg(u) \geq 3} (\deg(u) - 2) \geq n_{\geq 3}. \tag{1}$$

On the other hand,  $\chi_{NL}(G) = k$  implies  $n_1 \leq k(k-1)$  and  $n_2 \leq k \binom{k-1}{2}$ . Therefore,

$$\begin{aligned} n &= n_1 + n_2 + n_{\geq 3} \\ &\leq k \left( (k-1) + \binom{k-1}{2} \right) + n_1 \\ &\leq k \left( (k-1) + \binom{k-1}{2} \right) + k(k-1) \\ &= 2a_1(k) + a_2(k) \\ &= \frac{1}{2}(k^3 + k^2 - 2k). \end{aligned}$$

Now, assume that there is a unicyclic graph  $G$  attaining this bound. In such a case, the inequalities in the preceding expression must be equalities. Thus,  $n_{\geq 3} = n_1 = k(k-1)$ , and  $n_2 = k \binom{k-1}{2} = \frac{k(k-1)(k-2)}{2}$ . Finally, from Inequality 1, we deduce that  $n_{\geq 3} = n_1$  if and only if there are no vertices of degree greater than 3. Therefore, there are exactly  $n_{\geq 3}$  vertices of degree 3. Since  $n_{\geq 3} = n_1 = k(k-1)$ , the proof is complete.  $\square$

The bound given in Theorem 21 is tight for  $k \geq 5$ . To prove this, we first give a  $k$ -NL-coloring of the comb of order  $2k(k-1)$ . Recall that, for every integer  $m \geq 3$ , the *comb*  $B_m$  is the tree obtained by attaching one leaf at every vertex of  $P_m$ , the path of order  $m$ .

**Proposition 22.** *For every  $k \geq 5$ , there is a  $k$ -NL-coloring of the comb  $B_{k(k-1)}$ .*

*Proof.* Let  $k \geq 5$ . Consider the comb  $B_{k(k-1)}$  obtained by hanging a leaf to each vertex of a path  $P$  of order  $k(k-1)$ . We color with color 1 the leaves hanging from the first  $k-1$  vertices of the path  $P$ ; with color 2 the leaves hanging from the following  $k-1$  vertices of  $P$ ; and so on. For every  $r \in \{1, \dots, k\}$ , consider the set  $M_r$  containing the  $k-1$  vertices of  $P$  adjacent to the leaves colored with  $r$ . We define a bijection between the vertices of  $M_r$  and the  $k-1$  colors of the set  $L_r = \{1, 2, \dots, k\} \setminus \{r\}$ . Set  $M_r = \{x_1^r, \dots, x_{k-1}^r\}$  so that  $x_i^r x_{i+1}^r \in E(P)$  for every  $i \in \{1, \dots, k-2\}$ , and  $x_{k-1}^r x_1^{r+1} \in E$  if  $r < k$ .

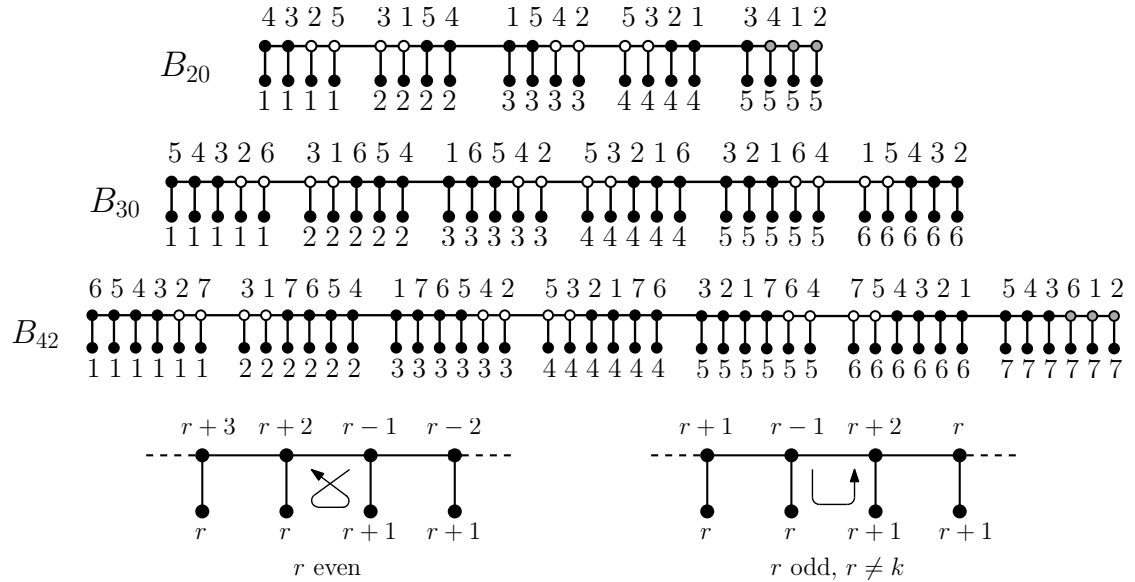

Figure 4: A 5-NL-coloring of the comb  $B_{20}$ , a 6-NL-coloring of the comb  $B_{30}$  and a 7-NL-coloring of the comb  $B_{42}$ . In white, adjacent vertices of  $M_r$  with no consecutive colors modulo  $k$ . In  $B_{20}$  and in  $B_{42}$ , we have shifted the colors of the vertices in gray with respect to the general rule used to the vertices of  $M_r$ , when  $r$  is odd. Below, the general rule for coloring adjacent vertices of consecutive groups  $M_r$  and  $M_{r+1}$  and the leaves hanging from them. In all cases, the colors involved are  $r-1, r, r+1$  and  $r+2$ .

We assign the colors of  $L_r$  in cyclically decreasing order to the vertices  $x_1^r, \dots, x_{k-1}^r$  beginning with different colors in each case:

- If  $r$  is even, then we begin with  $r+1$  modulo  $k$ . Therefore,  $x_1^r$  and  $x_2^r$  are colored respectively with  $r+1$  and  $r-1$  modulo  $k$ .
- If  $r$  is odd and  $r < k$ , then we begin with  $r-2$  modulo  $k$ . Therefore,  $x_{k-2}^r$  and  $x_{k-1}^r$  are colored respectively with  $r+1$  and  $r-1$  modulo  $k$ .
- If  $r$  is odd and  $r = k$ , then we proceed as in the case  $r$  odd and  $r < k$ , but we switch the colors of the last three vertices so that  $x_{k-3}^k, x_{k-2}^k$  and  $x_{k-1}^k$  have color  $k-1, 1$  and  $2$ , respectively.

See the defined  $k$ -NL-coloring of the comb  $B_{k(k-1)}$  for  $k \in \{5, 6, 7\}$  in Figure 4.

Notice that the colors of two consecutive vertices of  $M_r$  differ by one unit modulo  $k$ , except for the first two vertices, when  $r$  is even, and for the last two vertices, when  $r$  is odd. Besides, the first vertex of  $M_r$  is always colored with an odd number and the last vertex of  $M_r$  is colored with an even number whenever  $k$  is even or when  $k$  is odd and  $r \notin \{1, k-1, k\}$ . We claim that this procedure gives a  $k$ -NL-coloring of the comb  $B_{k(k-1)}$ .

We only have to prove that for every pair of non-leaves with the same color, the sets of colors of their neighborhoods are different.

Let  $l \in \{1, \dots, k\}$ . There are exactly  $k-1$  non-leaves colored with  $l$ , and exactly one of them belongs to  $M_r$ , for every  $r \in \{1, \dots, k\} \setminus \{l\}$ . Notice that the colors of the neighbors of  $v_l^r$  are  $\{r, l-1, l+1\}$ , except when  $v_l^r$  occupies the first or last positions in  $M_r$ . Concretely, this happens for  $r \in \{l-2, l-1, l+1\}$ , if  $l$  is even, and for  $r \in \{l-1, l+1, l+2\}$ , if  $l$  is odd, whenever  $l \neq \{1, 2, 3, k-1, k\}$ . Those last cases are analyzed separately.

We summarize in Table 1 the colors of the neighbors of  $v_l^r$ ,  $r \neq l$ , for all cases. Observe that the sets of colors of the neighbors of  $v_1^l, v_2^l, \dots, v_{k-1}^l$  are different for every case, so that we have a  $k$ -NL-coloring for each case.  $\square$

$l$ even, $l \neq 2, k-1, k$		$l$ odd, $l \neq 1, 3, k-1, k$	
$r$	colors of $N(v_l^r)$	$r$	colors of $N(v_l^r)$
$r \notin \{l-2, l-1, l+1\}$	$\{r, l-1, l+1\}$	$r \notin \{l-1, l+1, l+2\}$	$\{r, l-1, l+1\}$
$l-1$	$\{l-2, l-1, l+1\}$	$l-1$	$\{l-3, l-2, l-1\}$
$l+1$	$\{l+1, l+2, l+3\}$	$l+1$	$\{l-1, l+1, l+2\}$
$l-2$	$\{l-3, l-2, l+1\}$	$l+2$	$\{l-1, l+2, l+3\}$

$l = 1$		$l = 2$	
$r$	colors of $N(v_1^r)$	$r$	colors of $N(v_2^r)$
$r \notin \{2, 3, 4\}$	$\{r, 2, k\}$	$r \notin \{1, 3, k\}$	$\{r, 1, 3\}$
2	$\{2, 3, k\}$	1	$\{1, 3, k\}$
3	$\{3, 4, k\}$	3	$\{3, 4, 5\}$
$k$ even	$\{k-2, k-1, k\}$	$k$ even	$\{3, k\}$
$k$ odd	$\{2, k-2, k-1\}$	$k$ odd	$\{1, k\}$

$l = 3, k \geq 6$ even		$l = 3, k \geq 7$ odd	
$r$	colors of $N(v_3^r)$	$r$	colors of $N(v_3^r)$
$r \notin \{2, 4, 5, k-1, k\}$	$\{r, 2, 4\}$	$r \notin \{2, 4, 5, k-1, k\}$	$\{r, 2, 4\}$
2	$\{1, 2, k\}$	2	$\{1, 2, k\}$
4	$\{2, 4, 5\}$	4	$\{2, 4, 5\}$
5	$\{2, 5, 6\}$	5	$\{2, 5, 6\}$
$k-1$	$\{2, 4, k-1\}$	$k-1$	$\{2, k-1, k\}$
$k$	$\{2, 4, k\}$	$k$	$\{4, k-1, k\}$

$l = k-1, k$ even		$l = k-1, k$ odd	
$r$	colors of $N(v_{k-1}^r)$	$r$	colors of $N(v_{k-1}^r)$
$r \notin \{1, k-2, k\}$	$\{r, k-2, k\}$	$r \notin \{1, k-3, k-2, k\}$	$\{r, k-2, k\}$
1	$\{1, k-2\}$	1	$\{1, k-2\}$
$k-2$	$\{k-4, k-3, k-2\}$	$k-3$	$\{k-4, k-3, k\}$
$k$	$\{1, k-2, k\}$	$k-2$	$\{k-3, k-2, k\}$
		$k$	$\{1, 3, k\}$

$l = k, \text{ even}$		$l = k, \text{ odd}$	
$r$	colors of $N(v_k^r)$	$r$	colors of $N(v_k^r)$
$r \notin \{1, k-2, k-1\}$	$\{r, 1, k-1\}$	$r \notin \{1, k-1\}$	$\{r, 1, k-1\}$
1	$\{1, 2, 3\}$	1	$\{1, 2, 3\}$
$k-2$	$\{1, k-3, k-2\}$	$k-1$	$\{k-3, k-2, k-1\}$
$k-1$	$\{1, k-2, k-1\}$		

Table 1: Colors of the neighborhoods of non-leaves of the comb  $B_{k(k-1)}$ .

**Proposition 23.** For every  $k \geq 5$ , there is a unicyclic graph  $U_k$  with NLC-number  $\chi_{NL}(U_k) = k$  and order  $n(U_k) = 2a_1(k) + a_2(k)$ .

*Proof.* Consider the  $k$ -NL-coloring of the cycle  $C_{a_2(k)}$  obtained in the proof of Lemma 13, that is, with all vertices having color-degree 2. There is an edge  $xy$  with its endpoints  $x$  and  $y$  colored respectively with 2 and  $k - 1$ . Consider the  $k$ -NL-coloring of the comb  $B_{k(k-1)}$  given in the proof of Proposition 22. Let  $x'$  and  $y'$  be the vertices of degree 2 of the comb  $B_{k(k-1)}$  colored with  $k - 1$  and 2, respectively. Consider the unicyclic graph  $U_k$  obtained from the union of the cycle and the comb, deleting the edge  $xy$  from the cycle  $C_{a_2(k)}$  and adding the edges  $xx'$  and  $yy'$ . Notice that  $V(U_k) = V(C_{a_2(k)}) \cup V(B_{k(k-1)})$ , and thus the order of  $U_k$  is  $n(U_k) = n(C_{a_2(k)}) + n(B_{k(k-1)}) = a_2(k) + 2k(k - 1) = 2a_1(k) + a_2(k)$  (see in Figure 5 the case  $k = 6$ ).

We claim that the  $k$ -NL-colorings of the cycle and the comb induce a  $k$ -NL-coloring in  $U_k$ . We have only changed the colors of the neighborhoods of  $x'$  and  $y'$ . On the one hand  $x'$  has color  $k - 1$  and the colors of its neighbors are  $\{1, 2, k - 2\}$ . On the other hand,  $y$  has color 2 and the colors of its neighbors are  $\{3, k - 1, k\}$  if  $k$  is even, and  $\{1, k - 1, k\}$ , if  $k$  is odd. We can check in the tables given in the proof of Proposition 22 that any other vertex of the comb  $B_{k(k-1)}$  has different color or different set of colors in their neighborhoods from those of  $x'$  and  $y'$ . Hence, we have a  $k$ -NL-coloring of  $U_k$ .  $\square$

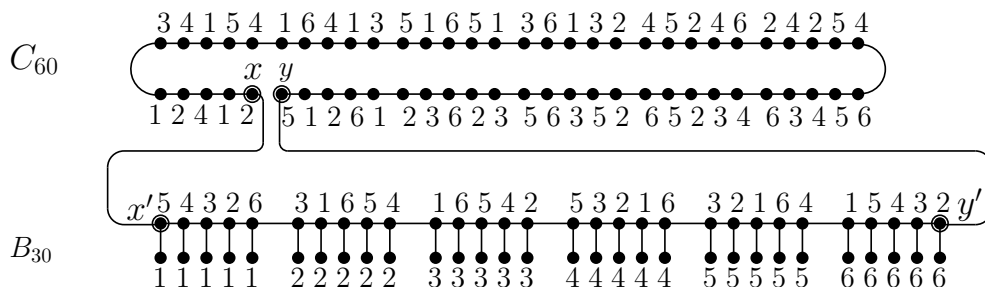

Figure 5: A 6-NL-coloring of the unicyclic graph  $U_6$ .

**Corollary 24.** For every  $k \geq 5$ , the bound given in Theorem 21 is tight.

## 5 Trees

In this section, we give some bounds for trees.

**Theorem 25.** Let  $T$  be a non-trivial tree. If  $\chi_{NL}(T) = k \geq 3$ , then

$$n(G) \leq 2a_1(k) + a_2(k) - 2 = \frac{1}{2}(k^3 + k^2 - 2k - 4).$$

Moreover, if the equality holds, then  $T$  has maximum degree 3 and it contains  $k(k - 1)$  leaves,  $\frac{k(k-1)(k-2)}{2}$  vertices of degree 2, and  $k(k - 1) - 2$  vertices of degree 3.

*Proof.* Let  $n$ ,  $n_1$ ,  $n_2$  and  $n_{\geq 3}$  be respectively the order, the number of leaves, the number of vertices of degree 2 and the number of vertices of degree at least 3 of a tree  $T$ . On the one hand, we know that

$$n_1 + 2n_2 + \sum_{\deg(u) \geq 3} \deg(u) = \sum_{u \in V(T)} \deg(u) = 2|E(T)| = 2(n-1) = 2(n_1 + n_2 + n_{\geq 3} - 1).$$

From here, we deduce that

$$n_1 = \sum_{\deg(u) \geq 3} (\deg(u) - 2) + 2 \geq n_{\geq 3} + 2. \quad (2)$$

On the other hand,  $\chi_{NL}(G) = k$  implies  $n_1 \leq k(k-1)$  and  $n_2 \leq k \binom{k-1}{2}$ . Therefore,

$$\begin{aligned} n &= n_1 + n_2 + n_{\geq 3} \\ &\leq k \left( (k-1) + \binom{k-1}{2} \right) + (n_1 - 2) \\ &\leq k \left( (k-1) + \binom{k-1}{2} \right) + k(k-1) - 2 \\ &= 2a_1(k) + a_2(k) - 2 \\ &= \frac{1}{2}(k^3 + k^2 - 2k - 4). \end{aligned}$$

Next, assume that there is a tree attaining this bound. In such a case, the inequalities in the preceding expression must be equalities. Thus,  $n_{\geq 3} = n_1 - 2 = k(k-1) - 2$ ,  $n_1 = k(k-1)$ , and  $n_2 = k \binom{k-1}{2} = \frac{k(k-1)(k-2)}{2}$ . Finally, from Inequality 2, we deduce that  $n_{\geq 3} = n_1 - 2$  if and only if there are no vertices of degree greater than 3. Therefore, there are exactly  $n_{\geq 3}$  vertices of degree 3. Since  $n_{\geq 3} = n_1 - 2 = k(k-1) - 2$ , the proof is complete.  $\square$

$\chi_{NL}(G)$	general graphs	$\Delta(G) = 2$	trees	trees		
$k$	$k(2^{k-1} - 1)$	$\frac{1}{2}(k^3 - k^2)$	$\frac{1}{2}(k^3 + k^2 - 2k - 4)$	$n_1$	$n_2$	$n_3$
3	9	9	<b>13</b>	<b>6</b>	<b>3</b>	<b>4</b>
4	28	24	<b>34</b>	<b>12</b>	<b>12</b>	<b>10</b>
5	75	50	68	20	30	18
6	186	90	118	30	60	28
7	441	147	187	42	105	40

Table 2: Upper bounds on the order of a graph for some values of  $\chi_{NL}(G)$ .

Table 2 illustrates Theorem 25. The cases in bold are not feasible because the bound for general graphs (see Theorem 2) is smaller than the specific bound for trees (see Theorem 25). The bound for graphs with  $\Delta = 2$  is given in Proposition 5. Bounds for unicyclic graphs (see Theorem 21) are the ones for trees adding two unities. The last column shows the number of vertices of degree 1 ( $n_1$ ), of degree 2 ( $n_2$ ) and of degree 3 ( $n_3$ ) that a tree attaining the upper bound has to have, as shown in Theorem 25.

For  $k = 3$ , the path  $P_9$  is an example attaining the general upper bound. For  $k = 4$ , a tree attaining the general upper bound  $n = 28$  is displayed in Figure 6. For  $k = 5$ , a tree of order 66 is shown in Figure 6. We do not know whether there are trees of order either 67

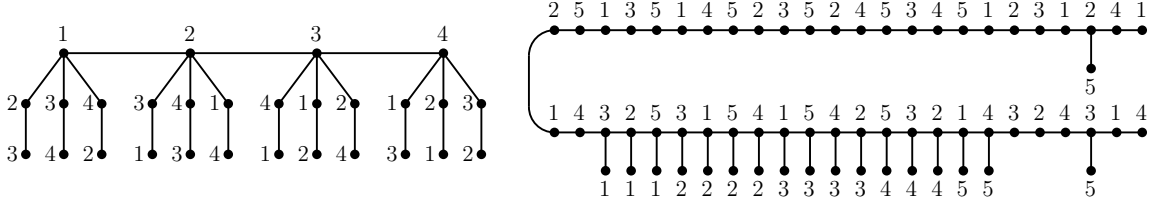

Figure 6: A tree  $T_1$  of order 28 and  $\chi_{NL}(T_1) = 4$  (left) and a tree  $T_2$  of order 66 and  $\chi_{NL}(T_2) = 5$  (right).

or 68 with NLC-number 5. Next proposition shows that there is a tree attaining the specific upper bound for trees whenever  $k \geq 6$ .

Recall that a *caterpillar* is a tree that reduces to a path when pruning all its leaves. Clearly, any comb is a caterpillar.

**Proposition 26.** *For every integer  $k \geq 6$ , there is a caterpillar  $T$  with NLC-number  $\chi_{NL}(T) = k$  and order  $n(T) = \frac{1}{2}(k^3 + k^2 - 2k - 4)$ .*

*Proof.* Consider the  $k$ -NL-coloring of the unicyclic graph  $U_k$  of order  $\frac{1}{2}k(k-1)(k+2)$  described in Proposition 23. Consider the leaf of color 2 hanging from the vertex  $x$  colored with  $k-1$ . Delete both vertices and add the edge joining the remaining neighbors of  $x$ . Do the same with the leaf colored with  $k-1$  hanging from the vertex  $y$  of color 2. Remove the edge joining the vertex  $u$  of degree 2 and color 2 with the vertex  $v$  of degree 3 and color  $k-1$ . Attach a leaf colored with  $k-1$  to vertex  $u$  and a leaf colored with 2 to vertex  $v$ . We obtain a tree  $T_k$  of order  $\frac{1}{2}k(k-1)(k+2) - 4 + 2 = \frac{1}{2}k(k-1)(k+2) - 2$  (see an example in Figure 7).

We claim that in such a way we have a  $k$ -NL-coloring of the tree  $T_k$ . Indeed, we have only changed the colors of the neighborhoods of the vertices adjacent to  $x$  and to  $y$  in  $T_k$ . Following the notations of the proof of Proposition 22, we have  $x = v_{k-1}^2$  and  $y = v_2^{k-1}$ , and, if  $k \geq 6$ , the vertices adjacent to them in  $M_2$  and  $M_{k-1}$  are respectively  $v_{k-2}^2, v_k^2$  and  $v_1^{k-1}, v_3^{k-1}$ . After deleting the vertices  $x$  and  $y$  from the comb, the colors of their neighborhoods are given in Table 3.

$z$	$v_1^{k-1}$	$v_3^{k-1}$	$v_{k-2}^2$	$v_k^2$
color of $z$	1	3	$k-2$	$k$
colors of $N(z)$ in $T_k$	$\{3, k-1, k\}$	$\{1, 4, k-1\}$	$\{2, k-3, k\},$ $\{1, 2, 6\},$	$\{1, 2, k-2\}$

Table 3: Set of colors of the neighborhoods.

Using Table 1, check that there are no vertices with the same color having the same set of colors in their neighborhoods in  $T_k$ . Therefore, we have a  $k$ -NL-coloring of  $T_k$ .  $\square$

Finally, some others results involving the NLC-number of trees are shown.

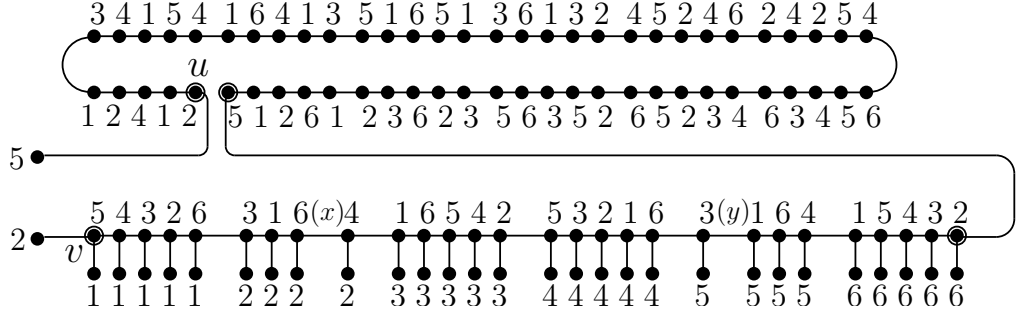

Figure 7: A 6-NL-coloring of a tree of order 118 constructed from a 6-NL-coloring of a unicyclic graph of order 120.

**Proposition 27.** *Let  $T$  be a tree of order  $n(T) = n \geq 5$ . If  $T$  is a star, then  $\chi_{NL}(T) = n(T)$ ; otherwise  $\chi_{NL}(T) \leq n(T) - 2$ .*

*Proof.* If  $\text{diam}(T) = 2$ , then  $T$  is a star and thus  $\chi_{NL}(T) = n$  (see [1]).

If  $\text{diam}(T) = 3$ , then  $T$  is a double star, that is,  $T$  has exactly two adjacent vertices  $u$  and  $v$  which are not leaves; and  $u$  is adjacent to  $r$  leaves and  $v$  is adjacent to  $s$  leaves,  $1 \leq r \leq s \leq n - 3$ . Hence,  $\chi_{NL}(T) = s + 1 \leq n - 2$  (see [6] and check that the coloring given in Proposition 4.1 is an NL-coloring).

If  $\text{diam}(T) \geq 4$ , then consider a pair of vertices  $x, y$  at distance 4, three vertices  $a, b, c$  such that  $xa, ab, bc, cy$  are edges of  $T$  and the following  $(n - 2)$ -NL-coloring: the same color for  $x, b$  and  $y$ , and a different color for every other vertex of  $T$ . Thus,  $\chi_{NL}(T) \leq n - 2$ .  $\square$

**Proposition 28.** *Let  $T$  be a tree. If  $\chi_{NL}(T) = k$ , then  $\Delta(T) \leq (k - 1)^2 + \frac{k-1}{2}$ .*

*Proof.* Suppose to the contrary that  $\Delta(T) > (k - 1)^2 + \frac{k-1}{2}$ . If  $u$  is a vertex of degree  $\Delta$  and color  $k$ , then its neighbors have colors  $1, \dots, k - 1$ . It can be easily proved that  $u$  has at most  $(k - 1)^2$  neighbors of degree at most 2. Hence,  $u$  must have  $> \frac{k-1}{2}$  neighbors of degree at least 3. Thus, the number  $n_1$  of leaves satisfies  $n_1 > (k - 1)^2 + 2\frac{k-1}{2} = k(k - 1)$ . But  $T$  has at most  $k(k - 1)$  leaves, getting a contradiction.  $\square$

## 6 Conclusions and open problems

We have determined the NLC-number of paths, cycles (see Theorem 7 and Theorem 17), and also of fans and wheels (see Theorem 19 and Theorem 20).

In [1], the order of a graph is bounded from above by a function of its NLC-number. In the present paper, we have achieved better bounds both for unicyclic graphs (see Theorem 21) and for trees (see Theorem 25). Moreover, we have shown that these new bounds are tight for NLC-number  $k \geq 5$  in the case of unicyclic graphs (see Proposition 23); and for NLC-number  $k \geq 6$  in the case of trees (see Proposition 26). In this last case, we have proved that the bound is achieved by a caterpillar. For trees with NLC-number  $k \geq 5$ , the maximum order according to our bound is 68, but the maximum order that we have obtained is 66. The existence or not of trees with NLC-number 5 and order 67 or 68 remains open.



According to Theorem 2(2), if  $\chi_{NL}(G) = k$  and  $\Delta(G) \leq k - 1$ , then  $n(G) \leq \sum_{j=1}^{\Delta(G)} a_j(k)$ .

In general, it is not known whether or not this bound is tight. For  $\Delta(G) = k - 1$ , this bound match with the one given in Theorem 2(1) which is known to be tight. Since we have proved that if  $G$  is a cycle, then  $n = a_1(k) + a_2(k)$ , this fact implies that the referred bound is tight for graphs with maximum degree  $\Delta(G) = 2$ . What does it happen for graphs with  $\Delta(G) = 3$ ? We have shown that if  $G$  is either a tree or an unicyclic graph, then  $n \leq 2a_1(k) + a_2(k)$  and, obviously,  $2a_1(k) + a_2(k) < a_1(k) + a_2(k) + a_3(k)$ , so the bound is not achieved by these graphs. Is it achieved by other kind of graphs? This is an open problem, not only for graphs with maximum degree  $\Delta = 3$ , but also for graphs with  $4 \leq \Delta \leq k - 2$ .

We know that the bound given by the Proposition 28 is not tight. Indeed, for a tree  $T$  with NLC-number 3, Proposition 28 states that  $\Delta(T) \leq 5$ . However, by Theorem 2(1), we have that  $n(T) \leq 9$ . Then, it is easy to verify that  $\chi_{NL}(T) = 3$  and  $n(T) \leq 9$  implies  $\Delta(T) \leq 4$ .

In general, we postulate the following.

**Conjecture 29.** *Let  $k \geq 2$ . If  $T$  is a tree with  $\chi_{NL}(T) = k$ , then  $\Delta(T) \leq (k - 1)^2$ . Moreover, this bound is tight for every integer  $k \geq 2$ .*

For an example of a tree  $T$  with  $\chi_{NL}(T) = k$  and  $\Delta(T) = (k - 1)^2$ , see Figure 8.

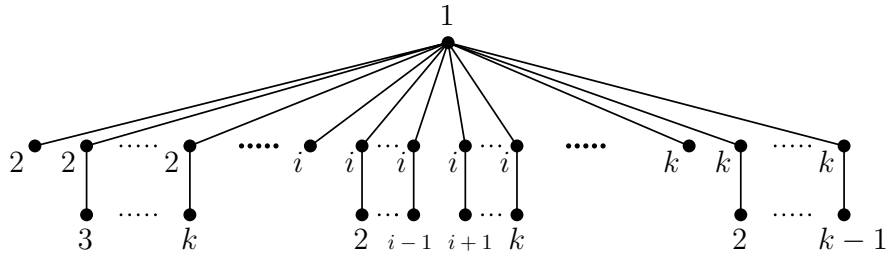

Figure 8: Tree  $T$  with  $\Delta(T) = (k - 1)^2$  and  $\chi_{NL}(T) = k$ .

If  $G$  is a connected graph of diameter  $\text{diam}(G) = d \leq 23$ , then, it is possible verify that  $\chi_{NL}(G) \geq \chi_{NL}(P_{d+1})$ . We propose the following conjecture.

**Conjecture 30.** *Let  $G$  be a graph of diameter  $d$ . Then,  $\chi_{NL}(G) \geq \chi_{NL}(P_{d+1})$ .*

## References

- [1] L. ALCON, M. GUTIERREZ, C. HERNANDO, M. MORA AND I. M. PELAYO: *Neighbor-locating colorings in graphs*. Theor. Comp. Sci., In Press.
- [2] E. T. BASKORO AND ASMIATI: *Characterizing all trees with locating-chromatic number 3*. Electron. J. Graph Theory Appl., **1** (2) (2013), 109–117.
- [3] A. BEHTOEI AND M. ANBARLOEI: *A Bound for the Locating Chromatic Numbers of Trees*. Trans. Comb., **4** (1) (2015), 31–41.

- [4] A. BEHTOEI AND B. OMOOMI: *On the locating chromatic number of Kneser graphs*. Discrete Appl. Math., **159** (18) (2011), 2214–2221.
- [5] G. G. CHAPPELL, J. GIMBEL AND C. HARTMAN: *Bounds on the metric and partition dimensions of a graph*. Ars Combinatoria, **88** (2008), 349–366.
- [6] G. CHARTRAND, D. ERWIN, M. A. HENNING, P. J. SLATER AND P. ZHANG: *The locating-chromatic number of a graph*. Bull. Inst. Combin. Appl., **36** (2002), 89–101.
- [7] G. CHARTRAND, D. ERWIN, M. A. HENNING, P. J. SLATER AND P. ZHANG: *Graphs of order  $n$  with locating-chromatic number  $n - 1$* . Discrete Math., **269** (2003), 65–79.
- [8] G. CHARTRAND, E. SALEHI AND P. ZHANG: *The partition dimension of a graph*. Aequationes Mathematicae, **59** (2000), 45–54.
- [9] M. FEHR, S. GOSSELIN, AND O. R. OELLERMANN: *The partition dimension of Cayley digraphs*. Aequationes Mathematicae, **71** (1-2) (2006), 1–18.
- [10] H. FERNAU, J. A. RODRÍGUEZ-VELÁZQUEZ AND I. GONZÁLEZ-YERO: *On the partition dimension of unicyclic graphs*. Bull. Math. Soc. Sci. Math. Roumanie, **57(105)** (4) (2014), 381–391.
- [11] C. GRIGORIOUS, S. STEPHEN, R. RAJAN AND M. MILLER: *On the partition dimension of circulant graphs*. Computer Journal **60** (2017), 180–184.
- [12] F. HARARY AND R. MELTER: *On the metric dimension of a graph*. Ars Combinatoria, **2** (1976), 191–195.
- [13] C. HERNANDO, M. MORA AND I. M. PELAYO: *Resolving dominating partitions in graphs*. Discrete Appl. Math., In Press.
- [14] J. A. RODRÍGUEZ-VELÁZQUEZ, I. GONZÁLEZ YERO AND M. LEMANSKA: *On the partition dimension of trees*. Discrete Appl. Math., **166** (2014), 204–209.
- [15] P. J. SLATER: *Leaves of trees*. Proc. 6th Southeastern Conf. on Combinatorics, Graph Theory, and Computing, Congr. Numer., **14** (1975), 549–559.
- [16] P. J. SLATER: *Dominating and reference sets in a graph*. J. Math. Phys. Sci., **22** (4) (1988) 445–455.
- [17] D. WELLYANTI, E. T. BASKORO, DARMAJI, R. SIMANJUNTAK AND S. UTTUNGGADEWA: *On locating-chromatic number of complete  $n$ -ary tree*. AKCE Int. J. Graphs Comb., **10** (3) (2013), 309–315.