

A Novel High Step-Up Secondary Side Impedance Source Full-Bridge Converter

Navid Salehi, Herminio Martínez-García, Guillermo Velasco-Quesada
 Electronic Engineering Department, Eastern Barcelona School of Engineering (EEBE)
 Technical University of Catalonia - BarcelonaTech (UPC),
 Eduard Maristany Ave., nº 10 – 14. E-08019. Barcelona, Spain
 navid.salehi65@gmail.com ; { herminio.martinez ; guillermo.velasco }@upc.edu

Abstract—In order to suppress the voltage stress of semiconductor devices, and solve the reverse recovery problem of diodes by decreasing the duty cycle of switches, impedance source converters could be consider as a solution. In this paper an impedance network is applied to the secondary side of a phase-shifted full-bridge converter in order to reduce the voltage stress of rectifier diodes. The proposed impedance network involves coupled inductors and capacitors that provide a new rectifier configuration for the converter. Operational principles of the proposed converter along with its theoretical analysis is investigated, and finally simulation results is provided by Pspice to verify the performance of the converter.

Index Terms—High step-up converter, Impedance source converter, Phase-shifted full-bridge converter, voltage stress.

I. INTRODUCTION

BY increasing the energy demand over previous years, renewable energies such as solar energy play a crucial role in order to supply the required energy of consumers. However, one of the main features of renewable energies like solar and fuel cells is low voltage production, so it is not possible to be used as input source for inverters [1]. In photovoltaic power plant low output voltage of solar panels can be compensate by connecting them in series; however, in residential application due to the few number of used panels it is not possible to increase the voltage to the acceptable level. Therefore, it is essential to apply a power converter as an interface in order to boost the voltage to the required level. Although conventional boost converter is able to increase the voltage gain by increasing the duty cycle, in practice it is not possible to implement. High voltage stress of output diode and switch, reverse recovery losses of diode, and high current spike of switch make it impossible to implement [2].

By increasing the popularity of high step-up converter in order to provide the resident's energy, many high step-up converters based on boost converter are introduced. Cascading several boost converters [3], interleaved boost converter [4], three level boost converter [5], and applying coupled inductor in these converters [6]-[8] are some regular introduced methods in order to increase the voltage gain specially in non-

isolated converters. Also, voltage stress of semiconductor devices is tried to reduce by passive clamp [9] or active clamp [10].

Moreover, in on-grid photovoltaic systems, using galvanic isolation converter is essential in order to increase the immunity of system and prevent damaging the system due to probable disturbance in power system [11]. Because of existence of isolation transformer in these converters, voltage gain can vary by tuning the turn ratio of transformer. However, voltage stress of rectifier's diodes at the output of isolated converter is still an important drawback.

In recent years, impedance source converters (ISC) become very popular as a high step-up converter due to providing some features such as high voltage gain, low voltage stress for semiconductor devices, high efficiency, and high reliability [12]. Analysis the steady state continues conduction mode (CCM) operation of a pulse width modulation (PWM) ISC is investigated in [13]. Generally, impedance network can be applied to DC-DC, DC-AC, AC-DC, and AC-AC power conversion, and usually lead to vary the operational behavior of converter [14]. When isolated converters are considered as a high step-up converter, the voltage stress of switches at the input side of converter is not problematic; however, the semiconductor devices at output side experience a high voltage stress. In [15] all different galvanically isolated impedance source converters are reviewed.

According to the possibility of applying impedance network in AC-DC power conversion, in this paper a novel impedance network is inserted at the secondary side of the transformer in full-bridge converter. The proposed network is able to rectify the voltage, meanwhile the voltage stress of rectifier diode reduce. In addition, the implemented coupled inductors in the impedance network lead to enhance the boost characteristic of the impedance network, therefore, the turn ratio of transformer decrease significantly in comparison with traditional full-bridge converter.

In this paper, first of all the proposed converter is introduced and some prominent features of the proposed impedance network elaborate in section II. Different operation modes and converter analysis such as voltage gain and voltage stresses of diverse semiconductor devices are provided in section III. Section IV involves the simulation results in order

to verify the theoretical analysis, and finally conclusions are presented in the last section.

II. PROPOSED CONVERTER AND OPERATING PRINCIPLES

A. Proposed topology

Fig. 1 shows the proposed high step-up impedance source full-bridge converter. The proposed impedance network that is applied at the secondary side of transformer is composed of four coupled inductors, two capacitors, and two diodes. This impedance network works as a rectifier stage by hiring three diodes with lower voltage stress which is more efficient in comparison with regular full wave rectifier with four diodes and high voltage stress.

B. Principles of operation

Due to applying the phase shifted control technic for full-bridge inverter of the converter, resulted in existence of four different operation modes. In order to analysis the converter operation modes the following assumption are considered:

- All semiconductor devices and passive components are ideal
- The voltage variation of capacitors C_1 , C_2 , and C_3 can be ignored over a switching period in steady-state.
- The coupled inductors L_1 , L_2 , L_3 , and L_4 in impedance network are equal.
- Isolation transformer is considered ideal (without leakage inductance)

The equivalent circuit for different operation modes are presented in Fig. 2. Also, the theoretical waveforms of the proposed converter is shown in Fig. 3.

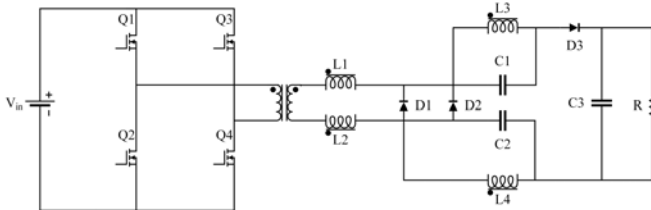

Fig. 1. Circuit diagram of proposed converter

Stage 1 $[t_0-t_1]$ (Fig. 2(a))

In this stage, switches Q_1 and Q_4 are conducting and energy is transferring from primary side to secondary side of transformer. Due to the configuration of coupled inductors in impedance network at the secondary side of transformer, inductors L_1 and L_2 conduct current to the load, however, inductors L_3 and L_4 act as flyback windings. Although L_3 and L_4 behave like flyback winding, the energy can't store in air-gap of core because of coupling with L_1 and L_2 . The following assumptions are made to simplify the equations:

$$V_{C_1} = V_{C_2} = V_C \quad (1)$$

$$V_{L_1} = V_{L_2} = V_L \quad (2)$$

By applying KVL at the secondary of transformer the following equation can be obtained:

$$V_L(t) + V_C(t) = \frac{nV_P - V_O}{2} \quad (3)$$

Where, V_P is the primary side voltage of transformer, V_O is output voltage, and n is turn ratio of transformer ($n = n_2/n_1$).

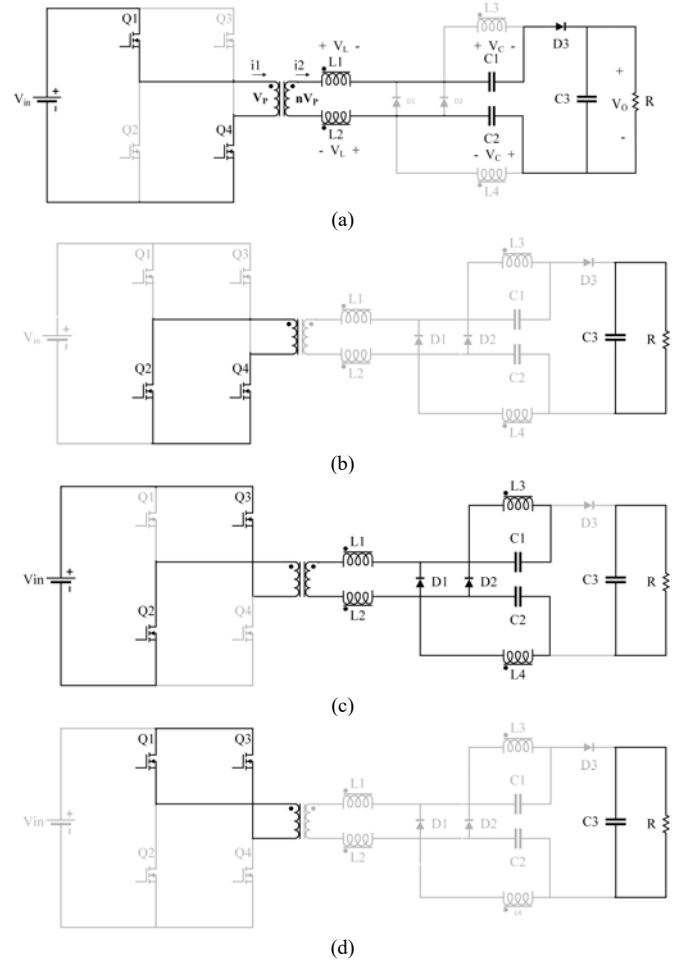

Fig. 2. Equivalent circuits of the proposed converter

Current of secondary side of transformer can be stated as:

$$i_2(t) = \frac{V_L}{Z} \sin(\omega(t - t_0)) \quad (4)$$

Where, V_L is the initial value at t_0 , $\omega = 1/\sqrt{(L_1 - M)C_1}$, $Z = \sqrt{(L_1 - M)/C_1}$, and M is the equivalent coupled inductor between L_1 and L_2 .

And voltage of L_1 can be expressed as:

$$V_L(t) = V_L \cos(\omega(t - t_0)) \quad (5)$$

Stage 2 $[t_1-t_2]$ (Fig. 2(b))

In this operation mode, due to applying the phase shifted control for switches, switch Q_1 turns off while switch Q_4 is still conducting. Also, because of changing the voltage polarity of transformer by decreasing the current, inductors L_1 and L_2 can't carry on current to the load; then, the load current is provided by output capacitor C_3 and also switch Q_4 lets current conducts by the body diode over this interval.

Stage 3 [t_2-t_3] (Fig. 2(c))

This stage starts when the switch Q_4 turns off and switch Q_3 begins conducting. The voltage polarity is applied to the primary of transformer in comparison with stage 1, therefore,

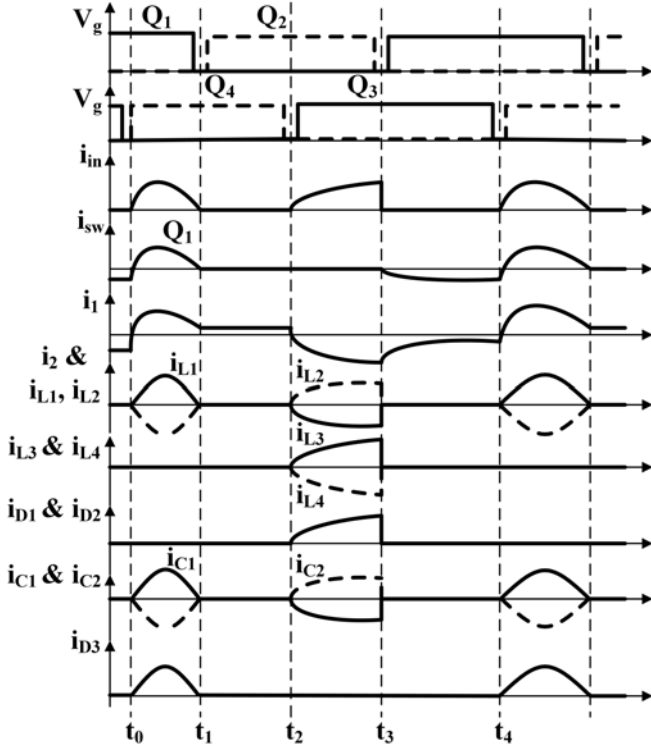

Fig. 3. Theoretical waveform of proposed converter

by transferring the energy to the secondary, voltage induce in all inductor's winding, however, the reverse bias of output diode D_3 leads to energy couldn't supply the load.

The current at the secondary of transformer can be expressed as:

$$i_2(t) = \frac{V_L}{Z'} \sin(\omega'(t - t_2)) \quad (6)$$

Where, $\omega' = 1/\sqrt{3(L_1 - M)C_1}$, $Z' = \sqrt{(L_1 - M)/3C_1}$, and M is the equivalent coupled inductor between inductors of impedance network.

Also voltage of L_1 can be calculated as:

$$V_L(t) = V_L \cos(\omega(t - t_2)) \quad (7)$$

Where, V_L here is the initial value at $t=t_2$.

Stage 4 [t_3-t_4] (Fig. 2(d))

This operation mode is similar to stage 2. In this stage switch Q_2 turns off and switch Q_1 turns on at the same time. Changing the voltage polarity of primary winding of transformer makes all inductors of impedance network not able to conduct current due to existence of diodes D_1 and D_2 . Although the stored energy in the inductors of impedance network is not acquirable in this interval, in next stage this energy will transfer to the load by means of L_1 and L_2 .

III. VOLTAGE GAIN AND VOLTAGE STRESS OF SEMICONDUCTORS

By considering the first stage of the operation principles of converter, it is possible to obtain the following voltage gain:

$$G = \frac{V_o}{V_{in}} = n - \frac{2}{n} + \frac{6V_L}{V_{in}} \quad (8)$$

Moreover, the voltage stress of semiconductor devices can be calculated easily by considering the different operation modes of converter. The voltage stress of inverter switches is the same as regular full-bridge converter equal to input voltage:

$$V_{Q1} = V_{Q2} = V_{Q3} = V_{Q4} = V_{in} \quad (9)$$

The first stage is appropriate also to calculate the voltage stress of diodes D_1 and D_2 :

$$V_{D1} = V_{D2} = V_o - 2V_L \cos(\omega DT_{sw}) \quad (10)$$

Where, D is the duty cycle and T_{sw} is the period of the converter operation, in fact DT_{sw} is the duration of first stage. Furthermore, the voltage stress of diode D_3 has the same equation that is stated in (10) by considering third stage, however, DT_{sw} in this case represents the duration of third stage.

IV. SIMULATION RESULTS

The simulation of proposed converter is performed by Pspice for input voltage of 24V, output voltage of 400V, and nominal power of 200W. Important characteristics of the designed converter are provided in Table 1.

The simulation waveforms are presented in Fig. 4. In Fig. 4(a) the input voltage and output voltage of converter can be observed. The input current waveform is shown in Fig. 4(b). Fig. 4(c) is related to the primary transformer current waveform. Moreover, Figs. 4(d) and 4(e) are shown the current waveforms of inductors L_1 and L_3 respectively. The waveforms of inductor L_2 is the same as L_1 , and inductor L_4 the same as L_3 with 180 degrees out of phase. Fig. 4(f) shows the voltage and current waveforms of diode D_1 , as you can observe the voltage stress of D_1 is much lower than output voltage. There is the same situation for diode D_3 which the voltage and current of D_3 is presented in Fig. 4(g). Also, the waveforms of diode D_2 is similar to D_1 .

As it can be observed, the performance of the proposed converter makes it appropriate to be utilized in on-grid photovoltaic systems by providing some effective features such as:

- Isolation can be obtain by lower turn ratio of transformer, so it makes the transformer lighter with lower power loss rather than conventional phase shifted full-bridge converter at the same power rate.
- Rectifier configuration is constructed by three diodes and the voltage stress is much lower than output voltage.

V. CONCLUSION

A new high step-up impedance source full-bridge converter was proposed in this paper. Unlike most isolated DC-DC impedance source converters that impedance network is inserted at the primary side of transformer, in the proposed converter in this paper the impedance network was applied to the secondary side in order to reduce the voltage stress of rectifier diodes. Moreover, the coupled inductors in the impedance network led to increasing the boost characteristic of impedance network and decreasing the turn ratio of transformer. Then, to verify the converter performance the simulation results for a 200-W output power is presented.

TABLE I
PRIMARY CHARACTERISTICS OF SIMULATED PROPOSED HIGH STEP-UP ISOLATED CONVERTER

Symbol	Parameter	Value
V_{in}	Input voltage	24 V
V_o	Output voltage	400 V
P	Output power	200 W
f_{sw}	Switching frequency	80 kHz
k	Coupling	0.99
N	Turn ratio of impedance network's inductors	1
n_1	Turns of primary windings of transformer	6
n_2	Turns of secondary windings of transformer	35
$L_1, L_2,$ L_3, L_4	Impedance network's inductors	100 μ H
C_1, C_2	Impedance network's capacitors	10 μ F
C_3	Output capacitor	100 μ F

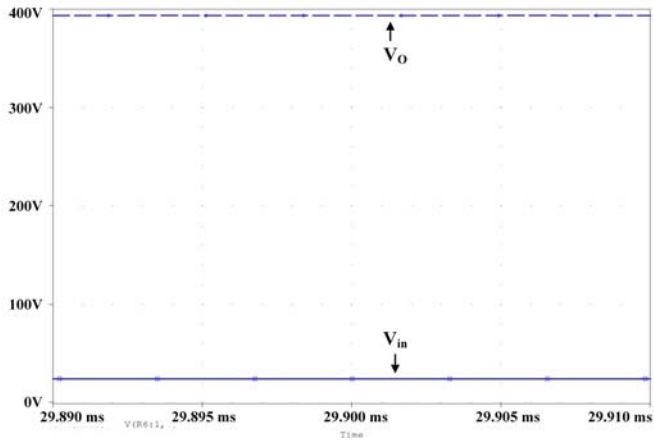

(a): input and output voltage

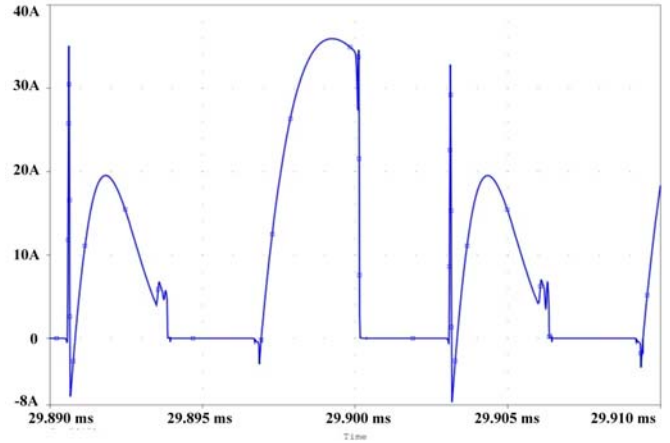

(b): input current waveform

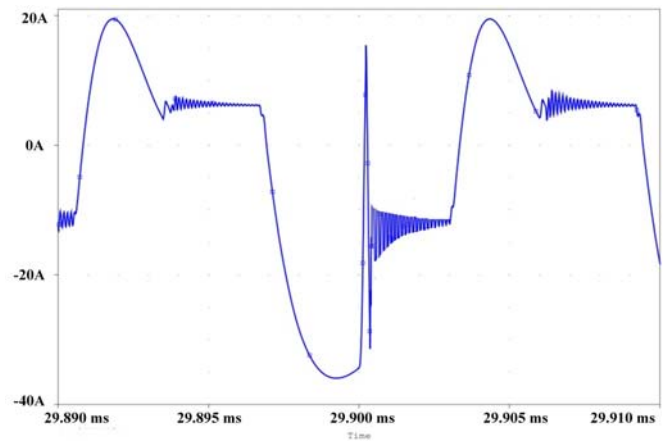

(c): primary transformer current waveform

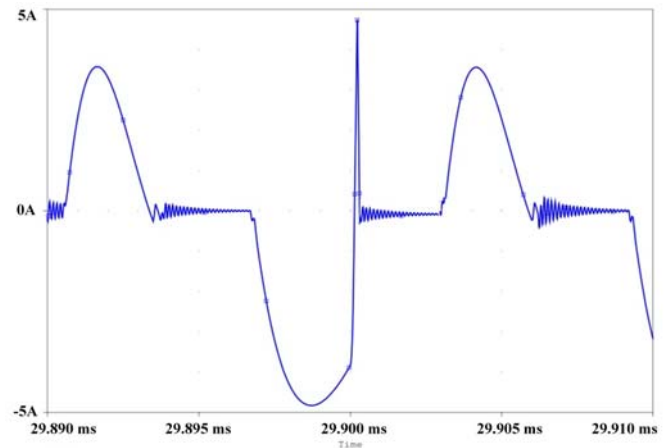

(d): Current waveform of L_1

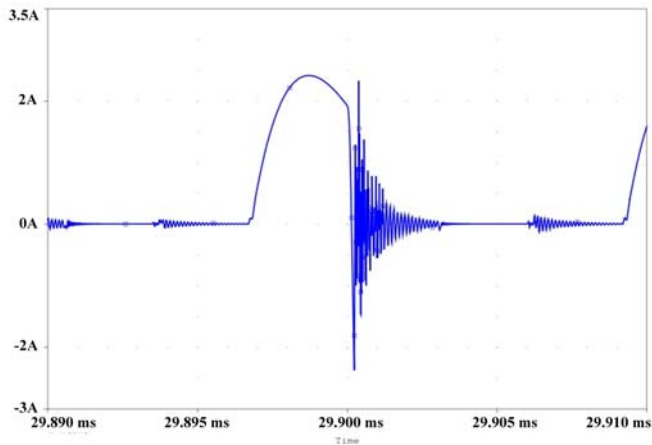

(e): current waveform of L_3

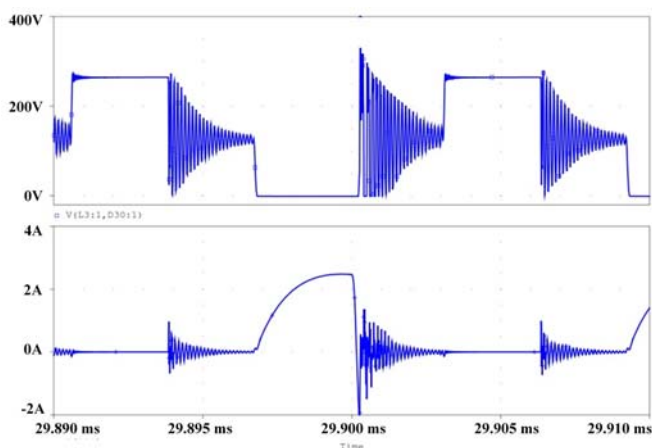

(f): Voltage and current waveforms of D_1

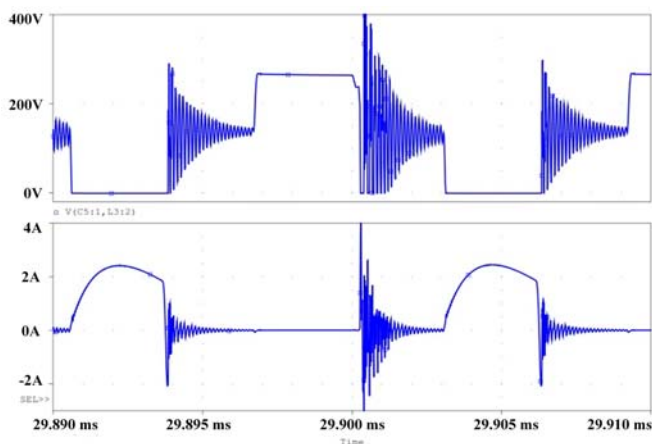

(g): Voltage and current waveforms of D_3

Fig. 4. Simulation waveform of proposed converter

the secondary side in order to reduce the voltage stress of rectifier diodes. Moreover, the coupled inductors in the impedance network led to increasing the boost characteristic of impedance network and decreasing the turn ratio of transformer. Then, to verify the converter performance the simulation results for a 200W output power is presented.

REFERENCES

- [1] Tseng, K.C., Huang, C.C., Shih, W.Y.: 'A high step-up converter with a voltage multiplier module for a photovoltaic system', *IEEE Trans. Power Electron.*, 2013, 28, (6), pp. 3047–3057
- [2] Tofoli, F.L., de Castro Pereira, D., de Paula, W.J. and Júnior, D.D.S.O. 'Survey on non-isolated high-voltage step-up dc–dc topologies based on the boost converter'. *IET power Electronics*, 2015, 8(10), pp.2044-2057.
- [3] Chen, S.M., Liang, T.J., Yang, L.S. and Chen, J.F. 'A cascaded high step-up DC–DC converter with single switch for microsource applications'. *IEEE Transactions on Power Electronics*, 2011, 26(4), pp.1146-1153.
- [4] Nouri, T., Hosseini, S.H., Babaei, E. and Ebrahimi, J. 'Interleaved high step-up DC–DC converter based on three-winding high-frequency coupled inductor and voltage multiplier cell'. *IET Power Electronics*, 2014, 8(2), pp.175-189.
- [5] Salehi, N., Mirtalaei, S.M.M. and Mirenayat, S.H. 'A high step-up DC–DC soft-switched converter using coupled inductor and switched capacitor'. *International Journal of Electronics Letters*, 2017, pp.1-12.
- [6] Zhou, Y., Huang, W., Zhao, P., Zhao, J.: 'Coupled-inductor single-stage boost inverter for grid-connected photovoltaic system', *IET Power Electron.*, 2014, 7, (2), pp. 259–270
- [7] Alisson Alencar Freitas, A., Lessa Tofoli, F., Mineiro Sá Júnior, E., Daher, S., Antunes, F.L.M.: 'High-voltage gain dc–dc boost converter with coupled inductors for photovoltaic systems', *IET Power Electron.*, 2015, 8, (10), pp. 1885–1892
- [8] Tseng, K.C., Lin, J.T., Huang, C.C.: 'High step-up converter with three-winding coupled inductor for fuel cell energy source applications', *IEEE Trans. Power Electron.*, 2015, 30, (2), pp. 574–581
- [9] Zhao, Y., Li, W., Deng, Y. and He, X. 'High step-up boost converter with passive lossless clamp circuit for non-isolated high step-up applications'. *IET power electronics*, 2011, 4(8), pp.851-859.
- [10] Hwu, K.I., Yau, Y.T.: 'High step-up converter based on coupling inductor and bootstrap capacitors with active clamping', *IEEE Trans. Power Electron.*, 2014, 29, (6), pp. 2655–2660.
- [11] Evran, F. and Aydemir, M.T. 'Isolated high step-up DC–DC converter with low voltage stress'. *IEEE Transactions on Power Electronics*, 2014, 29(7), pp.3591-3603.
- [12] Evran, F. and Aydemir, M.T. 'Z-source-based isolated high step-up converter'. *IET Power Electronics*, 2013, 6(1), pp.117-124.
- [13] Galigekere VP, Kazimierczuk MK. 'Analysis of PWM Z-source DC-DC converter in CCM for steady state.' *IEEE transactions on circuits and systems i: regular papers*. 2012 Apr; 59(4), pp. 854-63
- [14] Peng FZ. 'Z-source inverter.' *IEEE Transactions on industry applications*. 2003 Mar; 39(2), pp. 504-10
- [15] Chub, A., Vinnikov, D., Blaabjerg, F. and Peng, F.Z. 'A review of galvanically isolated impedance-source DC–DC converters.' *IEEE Transactions on Power Electronics*, 2016, 31(4), pp.2808-2828.