

TALLER DE ENCUADERNACIONES  
DE  
**A. LUQUE**  
30 · LEONES · 30 ·  
· SEGOVIA ·

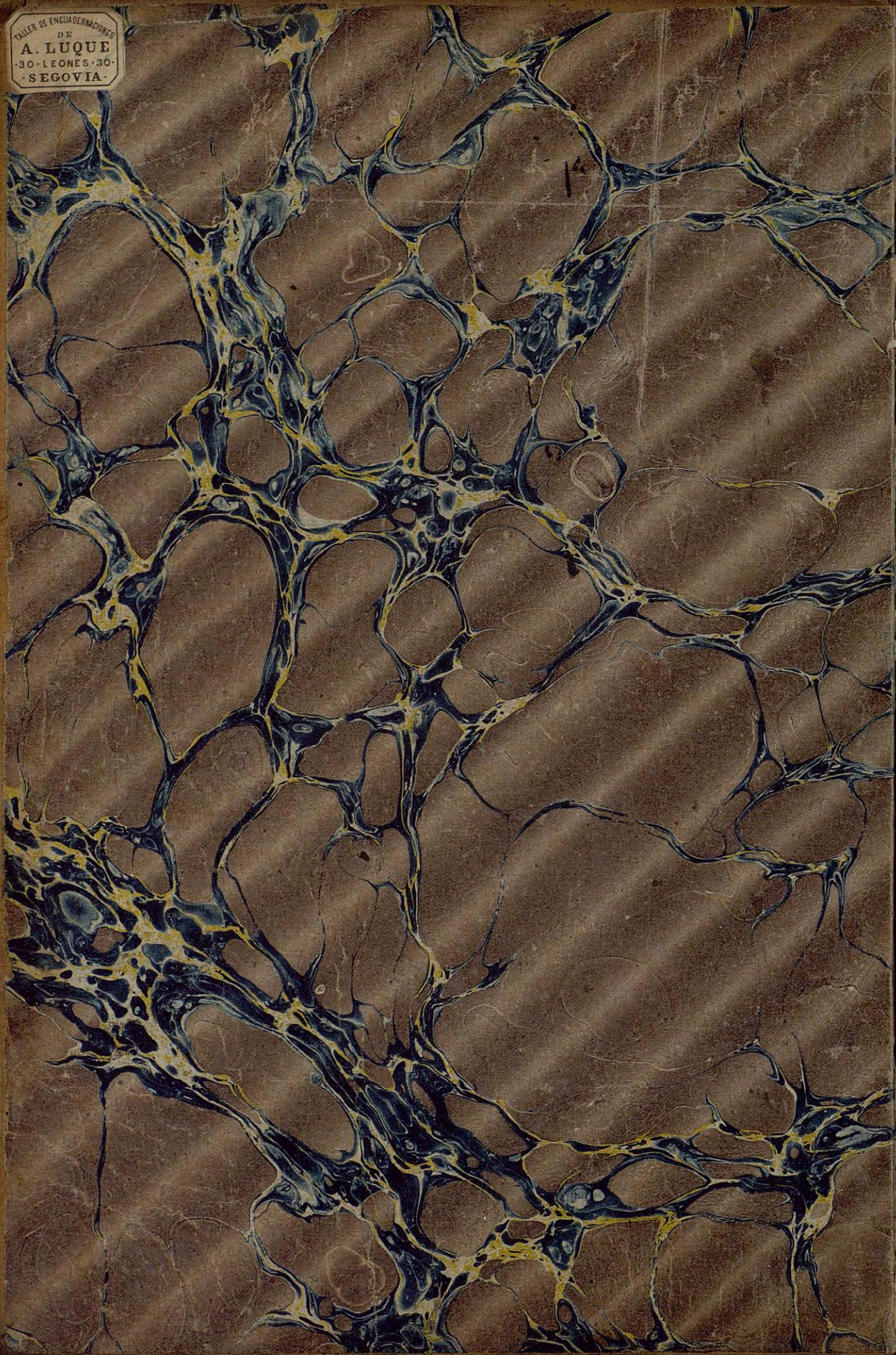

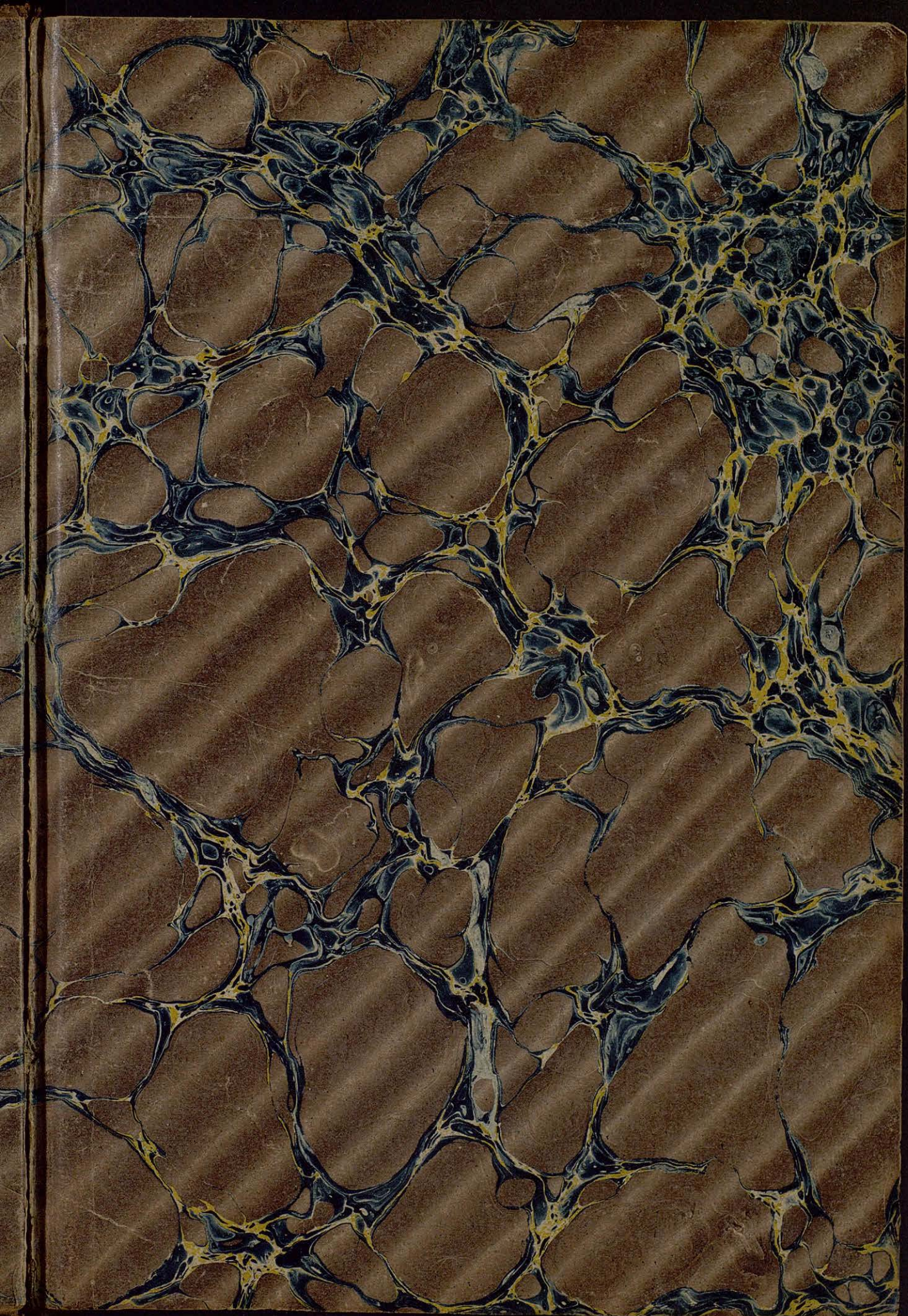

CURSO DE



ESCOLA SUPERIOR DE AGRICULTURA  
BIBLIOTECA.

Armari	B
Prestalga	1
Nombre	27

DON EUSE

COMPRADO DE BARCELLOS

ITA

**CURSO DE TOPOGRAFIA**

Y

**ELEMENTOS DE GEODESIA**

POR

**DON EUSEBIO SANZ,**

COMANDANTE DE EJÉRCITO Y CAPITAN DE ARTILLERÍA.

---

**ATLAS.**

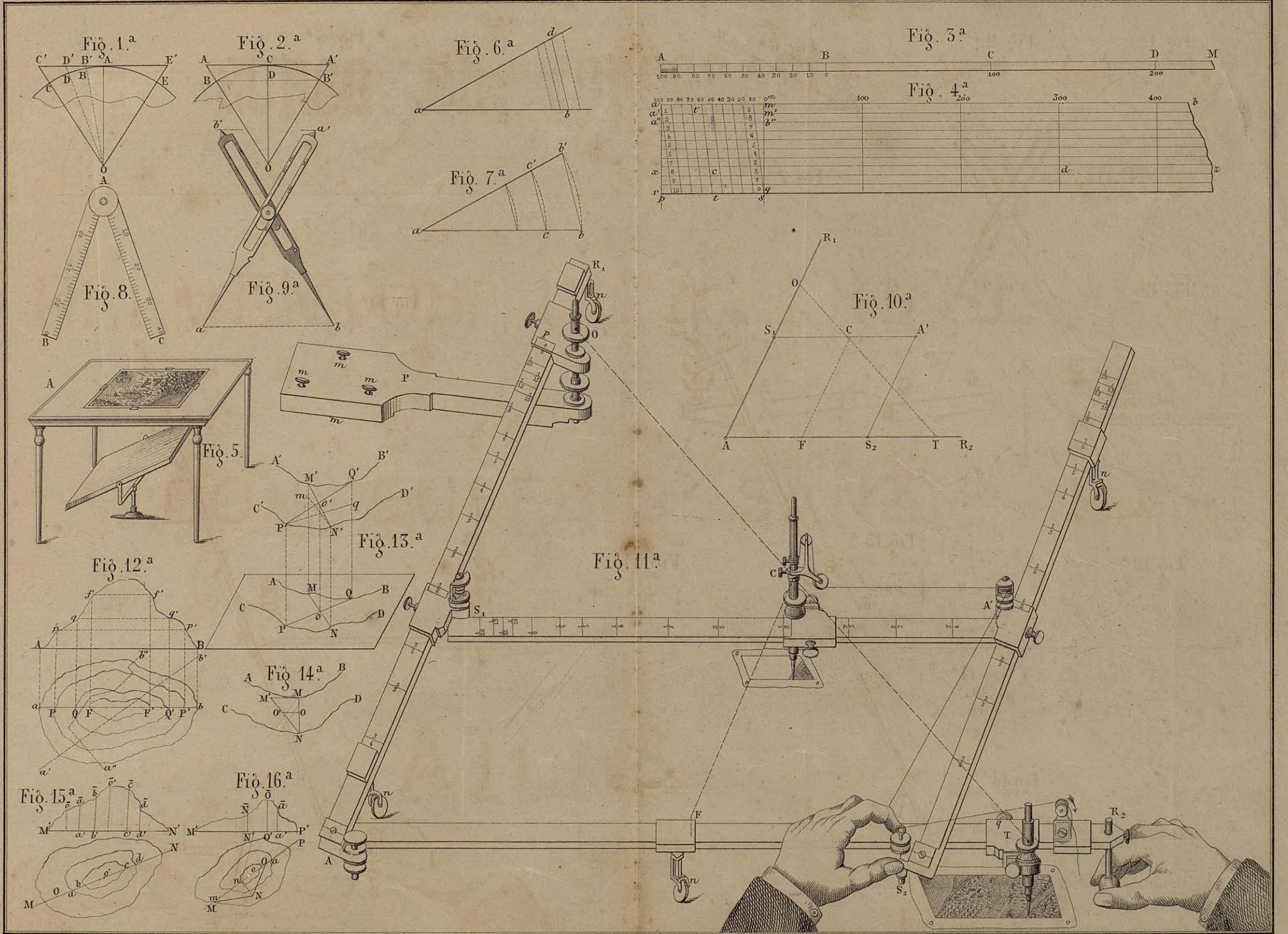

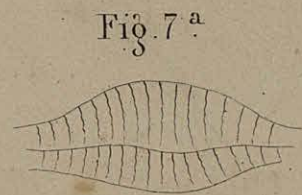
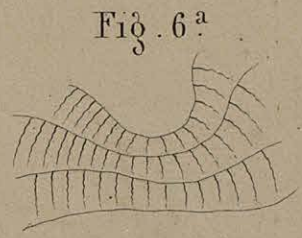
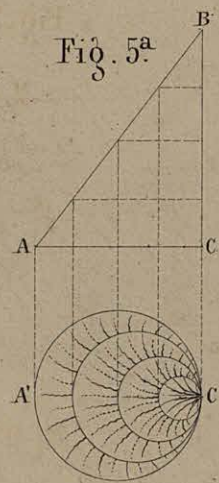
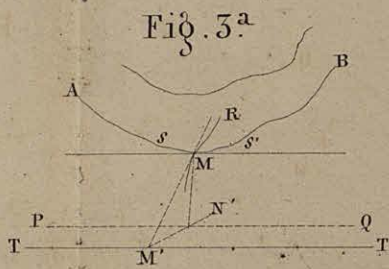
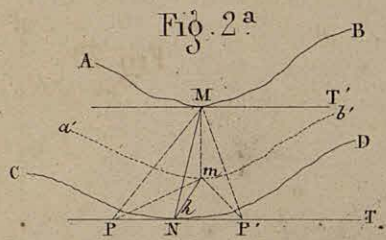
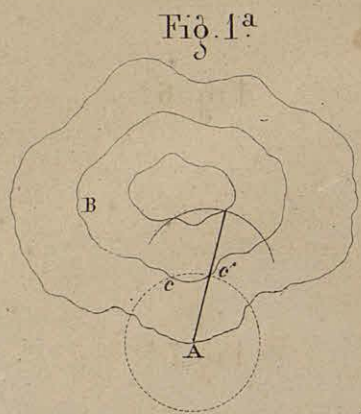

Fig. 8<sup>a</sup>

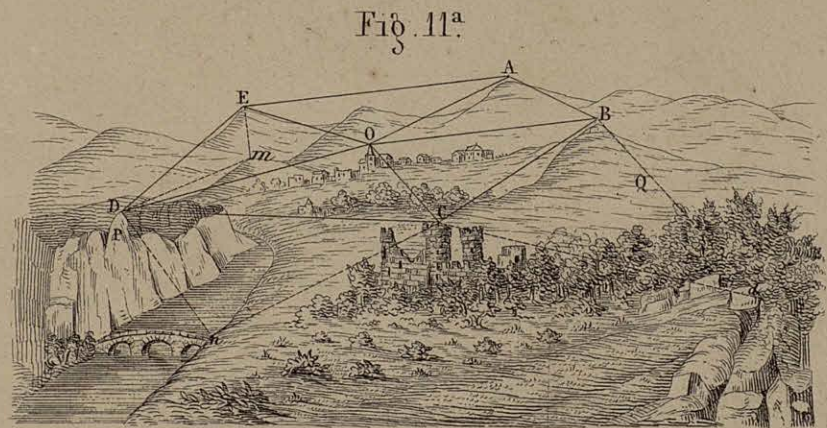
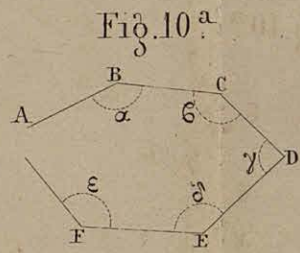

Fig. 9<sup>a</sup>

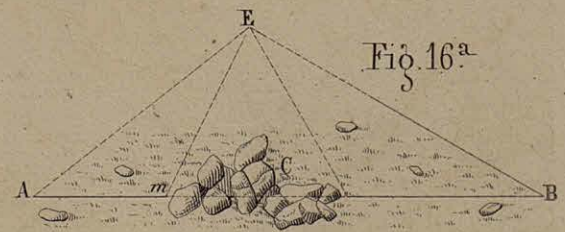
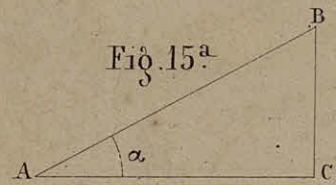
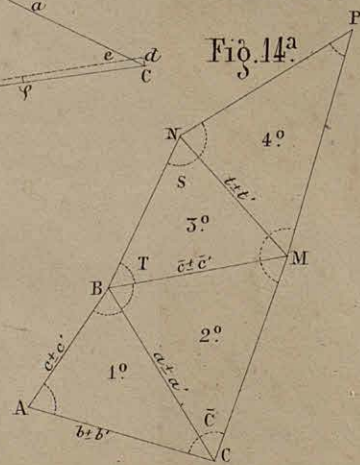
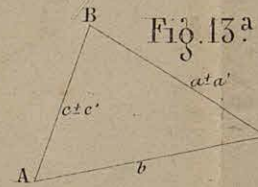
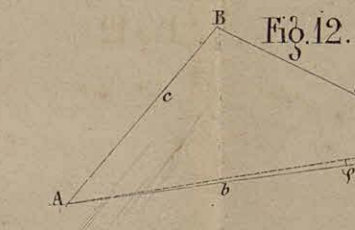
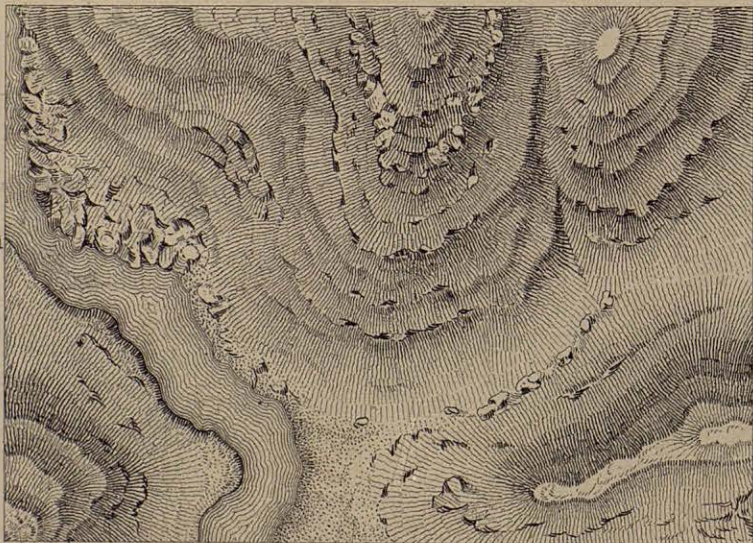

Fig. 1.<sup>a</sup>

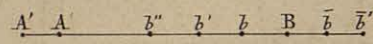

Fig. 2.<sup>a</sup>



Fig. 3.<sup>a</sup>



Fig. 4.<sup>a</sup>

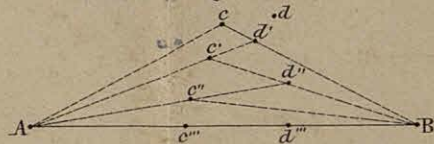

Fig. 5.<sup>a</sup>

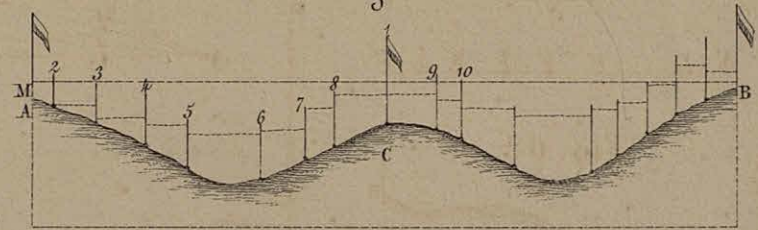

Fig. 6.<sup>a</sup>



Fig. 8.<sup>a</sup>

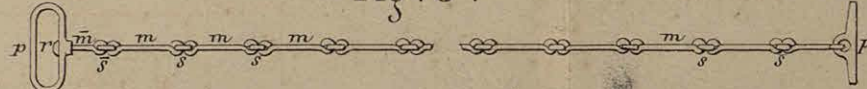

Fig. 10.<sup>a</sup>

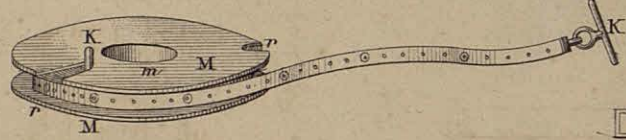

Fig. 7.<sup>a</sup>

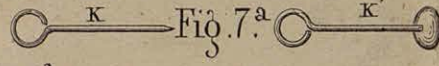

Fig. 11.<sup>a</sup>

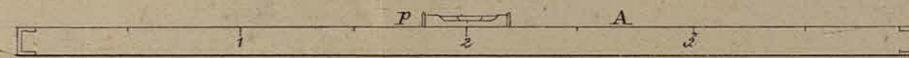

Fig. 9.<sup>a</sup>

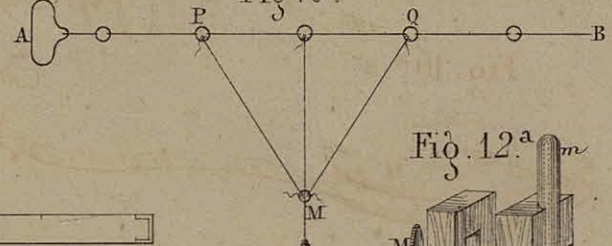

Fig. 12.<sup>a</sup>

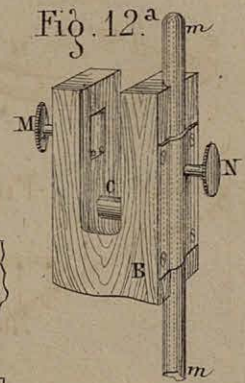

Fig. 13.<sup>a</sup>

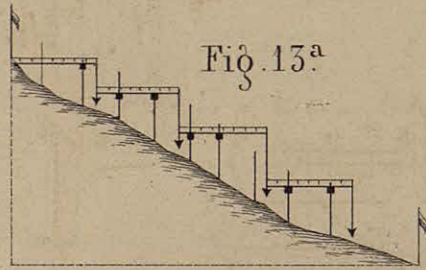

Fig. 14.<sup>a</sup>

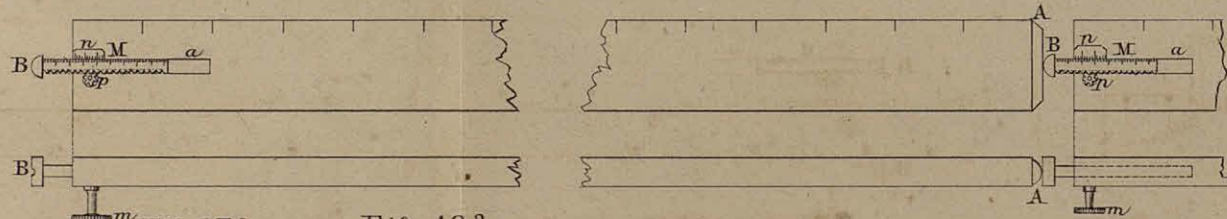

Fig. 15.<sup>a</sup>

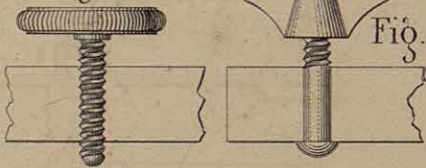

Fig. 16.<sup>a</sup>

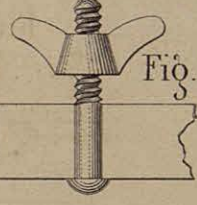

Fig. 17.<sup>a</sup>

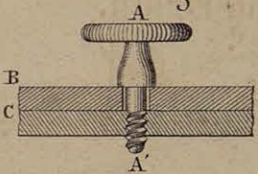

Fig. 18.<sup>a</sup>

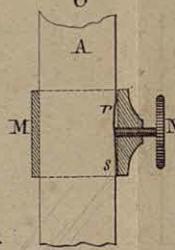

Fig. 19.<sup>a</sup>

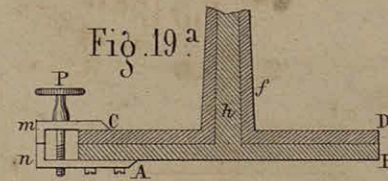

Fig. 20.<sup>a</sup>

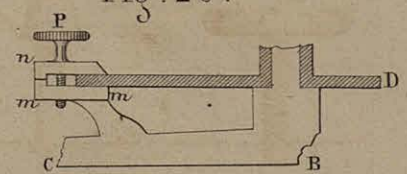

Fig. 21.<sup>a</sup>

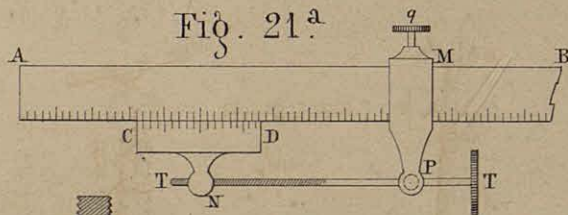

Fig. 22.<sup>a</sup>

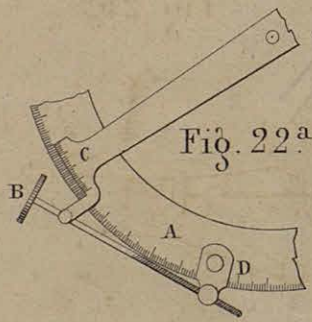

Fig. 23.<sup>a</sup>

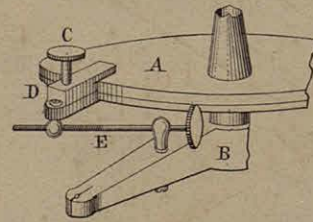

Fig. 24.<sup>a</sup>

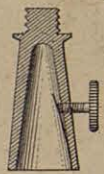

Fig. 25.

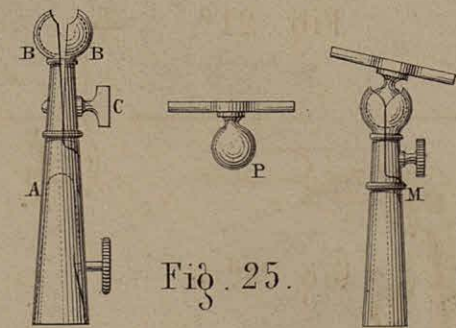



Fig. 1<sup>a</sup>

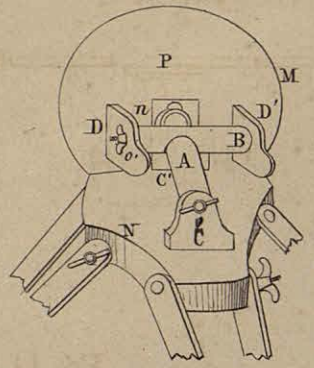

Fig. 2<sup>a</sup>

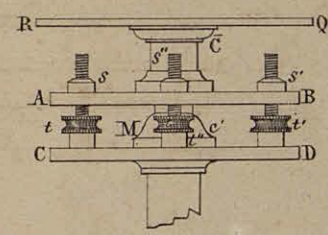

Fig. 3<sup>a</sup>

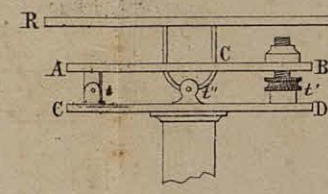

Fig. 4<sup>a</sup>

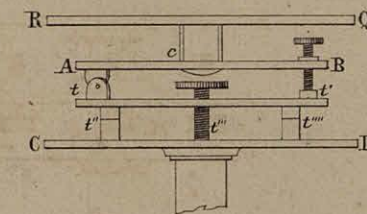

Fig. 5<sup>a</sup>

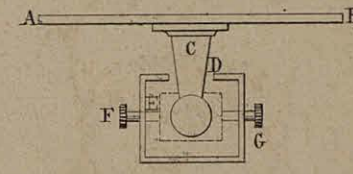

Fig. 8<sup>a</sup>

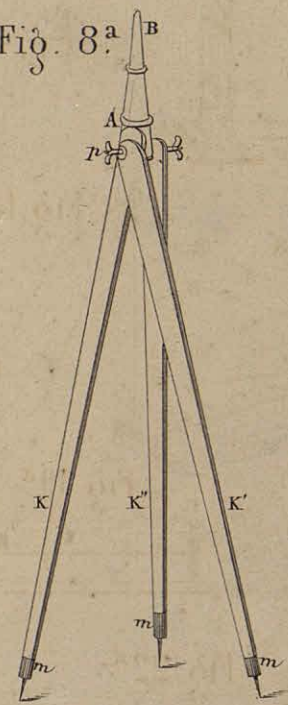

Fig. 9<sup>a</sup>

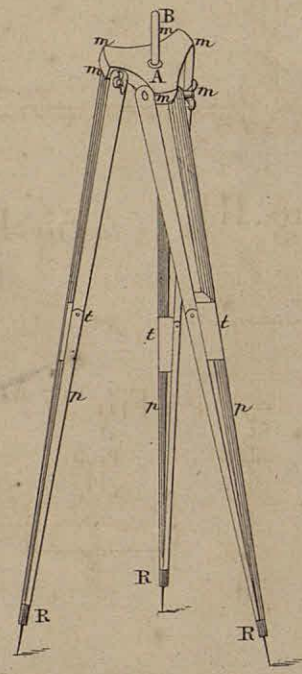

Fig. 7<sup>a</sup>

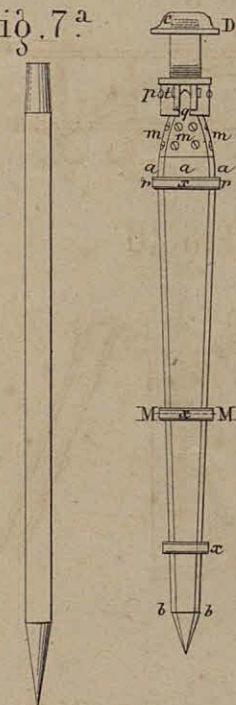

Fig. 12<sup>a</sup>

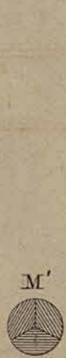

Fig. 6<sup>a</sup>

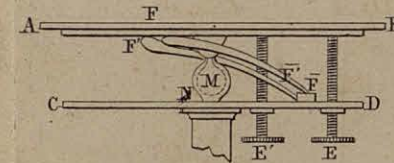

Fig. 13<sup>a</sup>

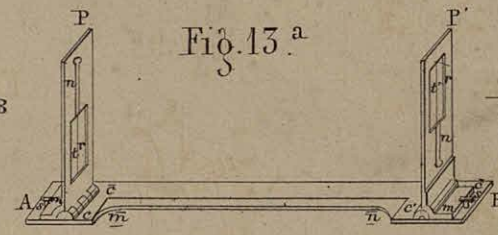

Fig. 14<sup>a</sup>



Fig. 10

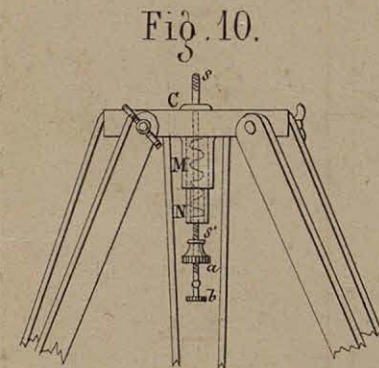

Fig. 11<sup>a</sup>

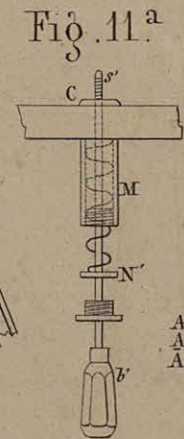

Fig. 15<sup>a</sup>

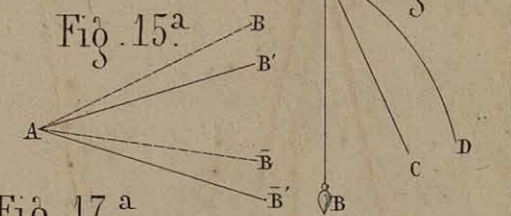

Fig. 18<sup>a</sup>

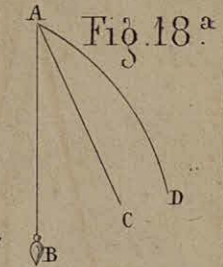

Fig. 17<sup>a</sup>

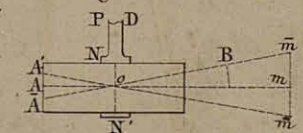

Fig. 19<sup>a</sup>

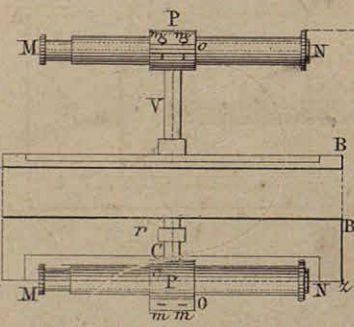

Fig. 16<sup>a</sup>

Fig. 20<sup>a</sup>

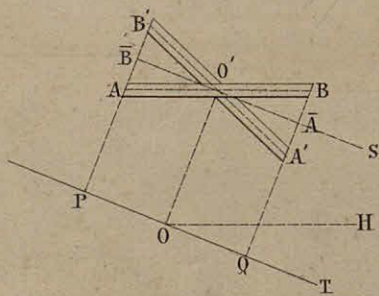

Fig. 21<sup>a</sup>

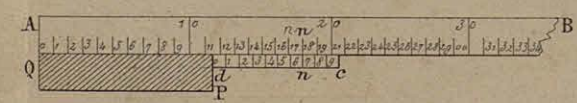
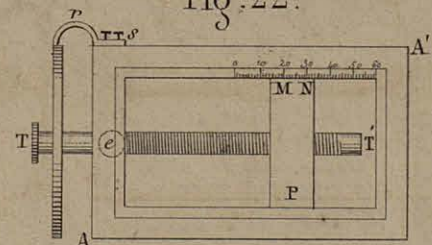
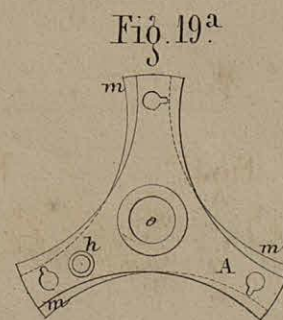
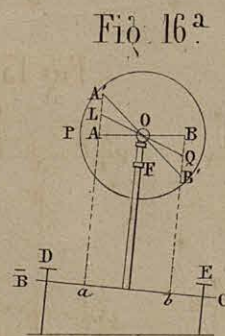
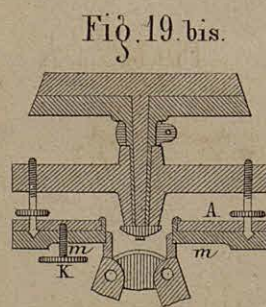
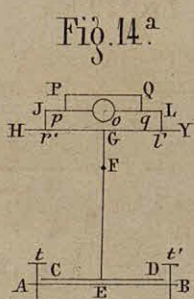
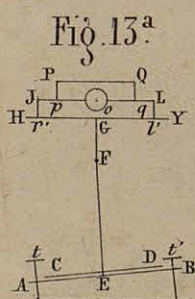
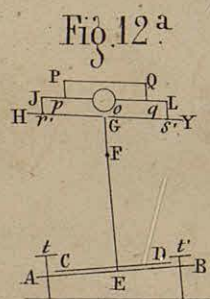
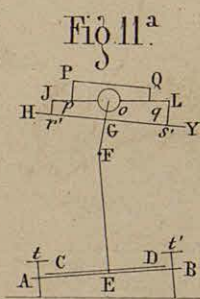
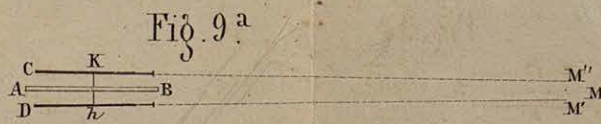
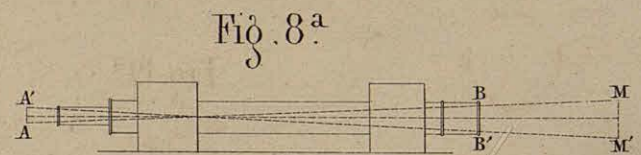
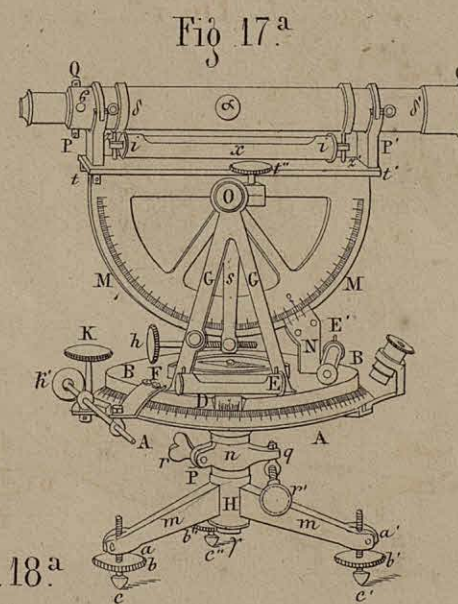
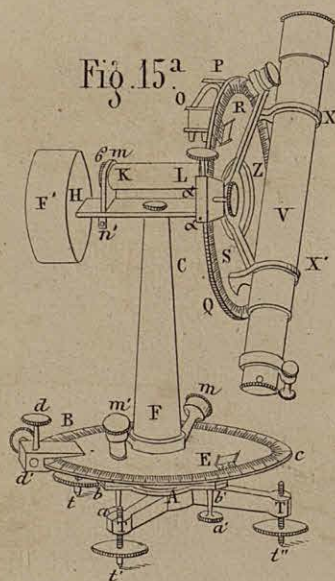
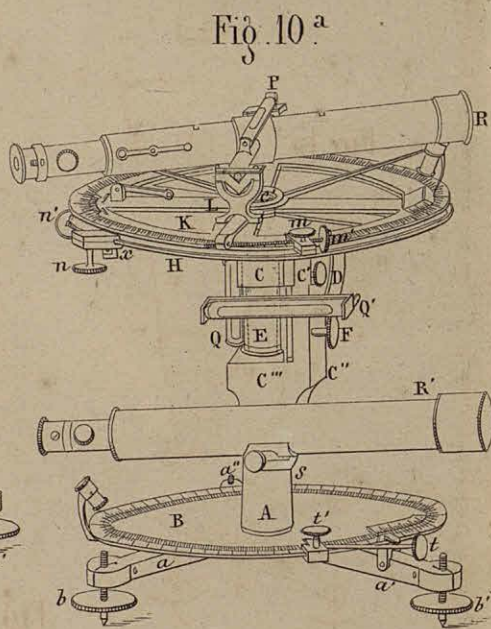
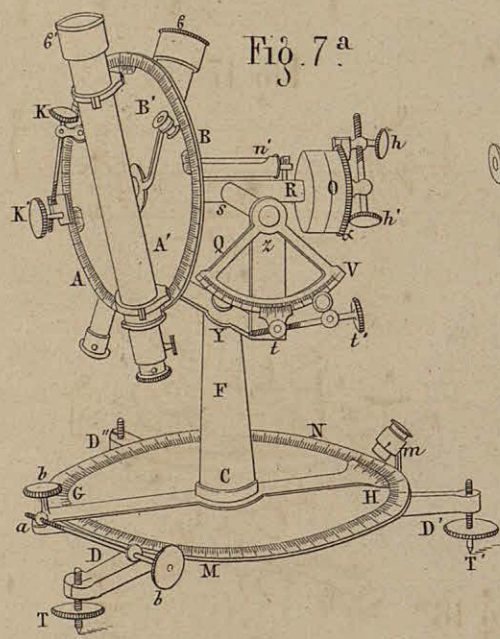
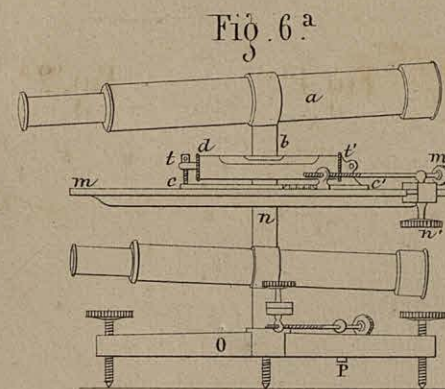
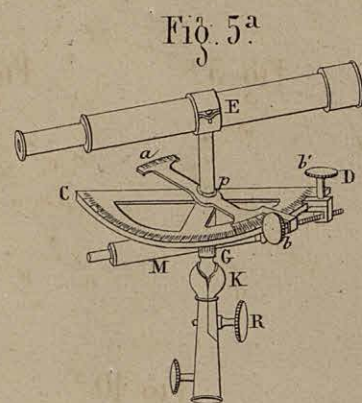
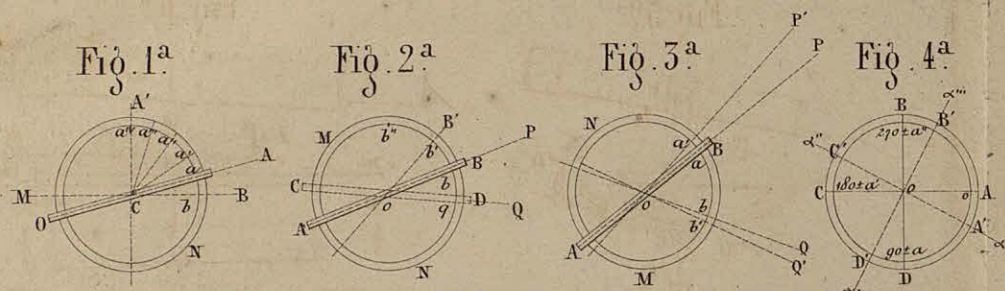

Fig. 22<sup>a</sup>





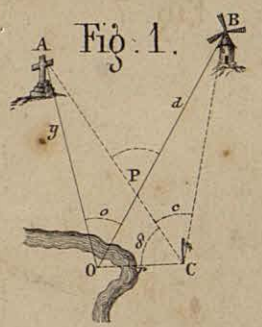

Fig. 1.

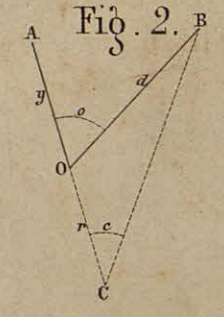

Fig. 2.

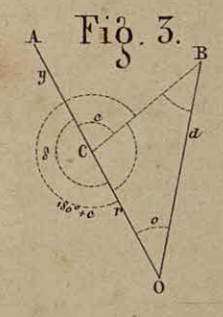

Fig. 3.

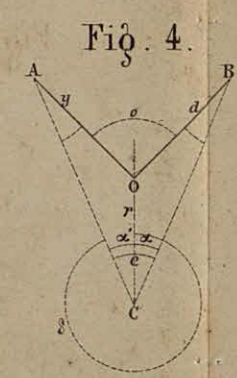

Fig. 4.

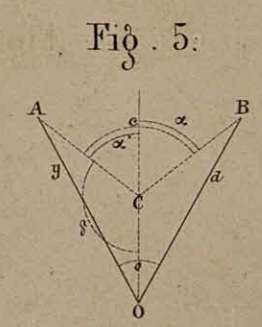

Fig. 5.

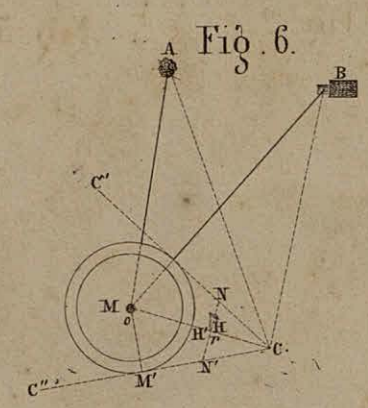

Fig. 6.

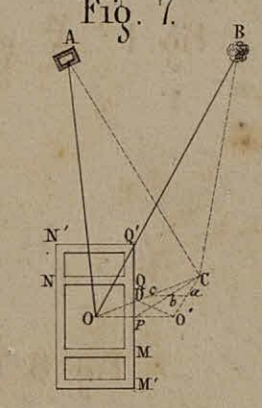

Fig. 7.

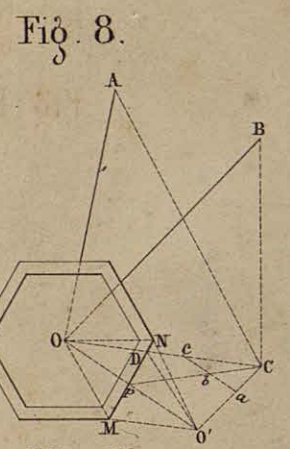

Fig. 8.

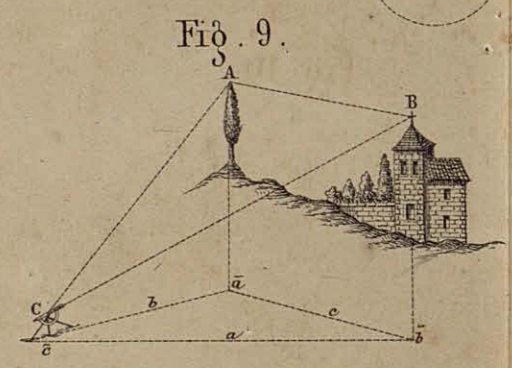

Fig. 9.

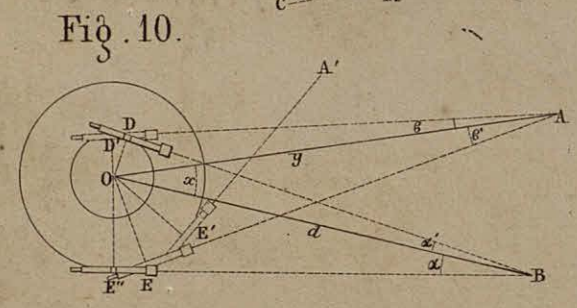

Fig. 10.

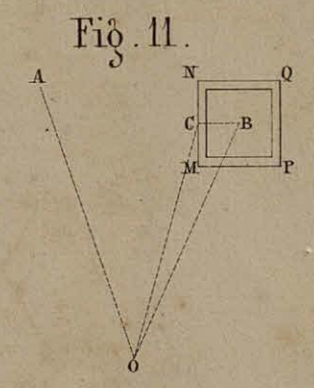

Fig. 11.

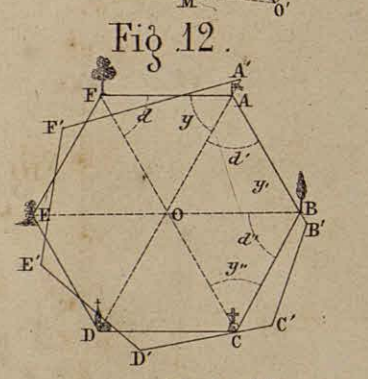

Fig. 12.

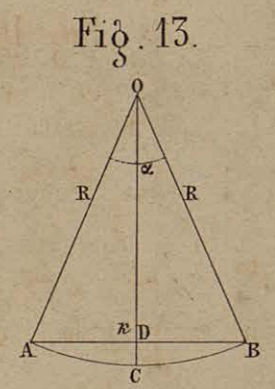

Fig. 13.

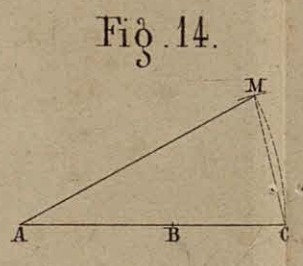

Fig. 14.

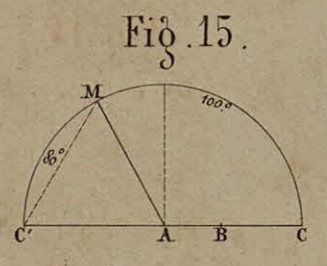

Fig. 15.

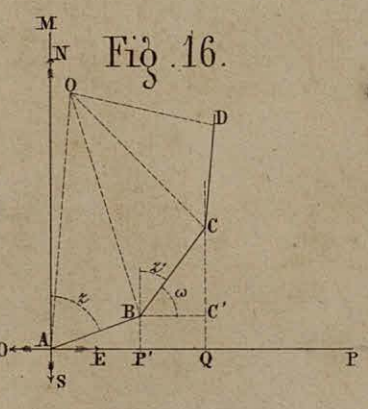

Fig. 16.

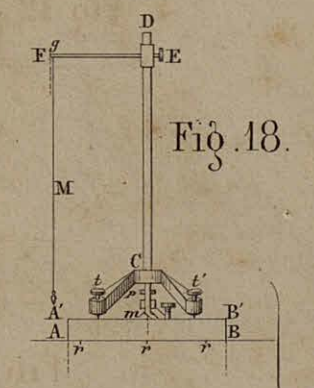

Fig. 18.

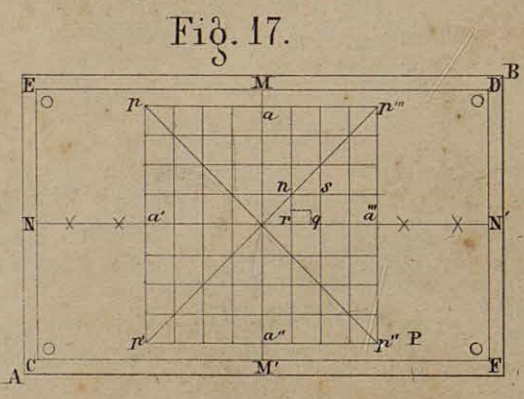

Fig. 17.

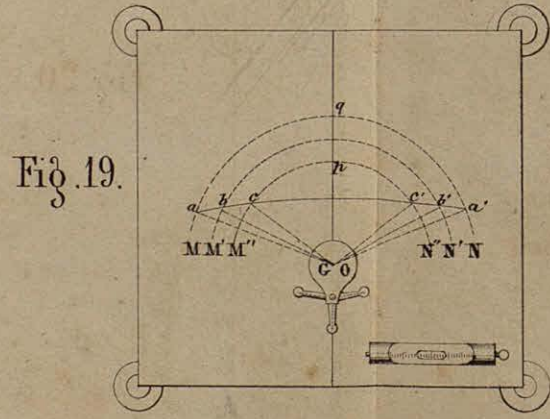

Fig. 19.

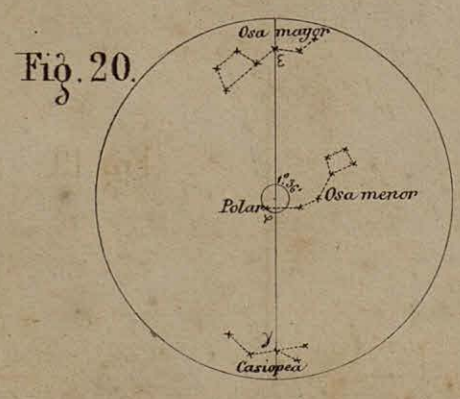

Fig. 20.

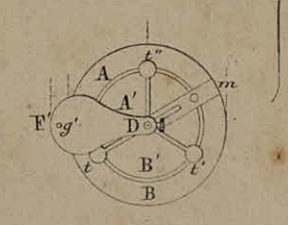

Fig. 11.

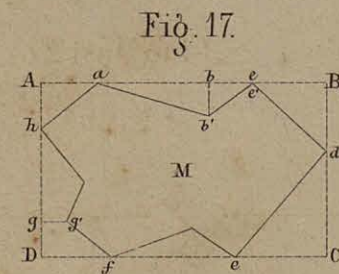
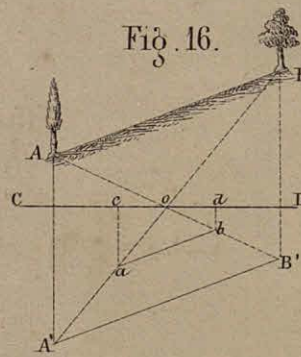
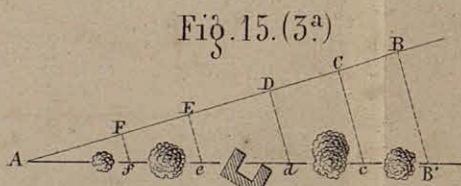
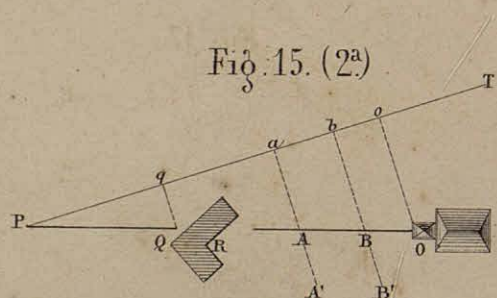
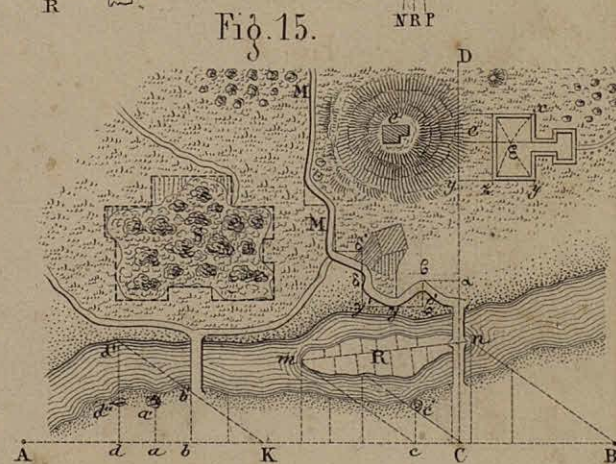
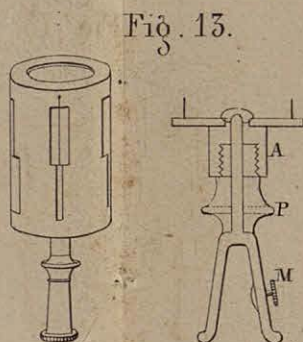
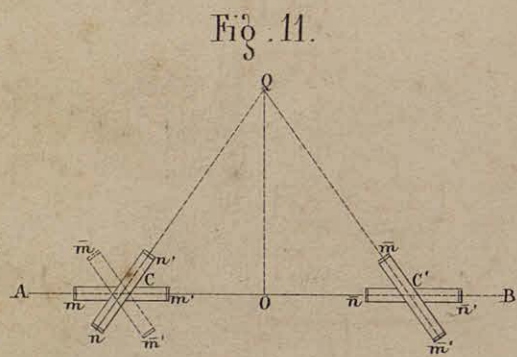
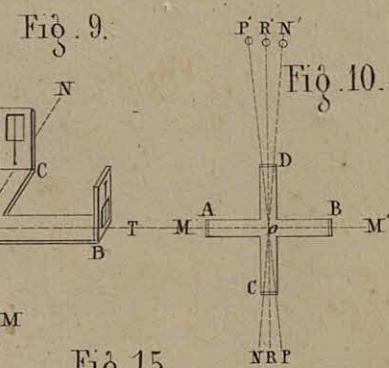
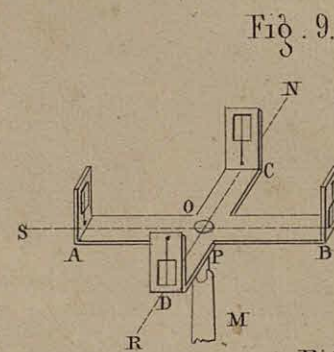
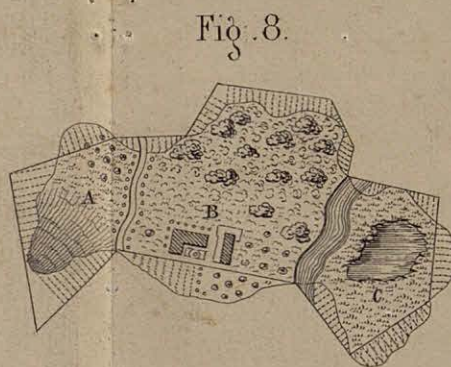
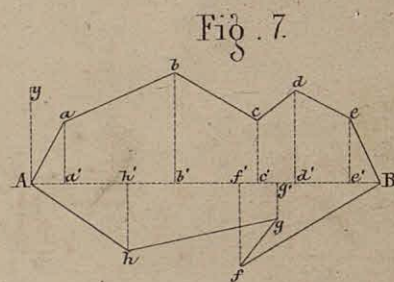
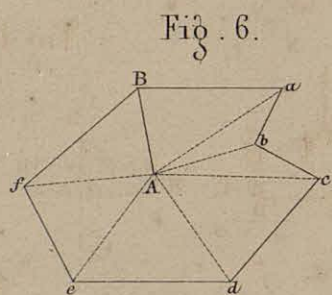
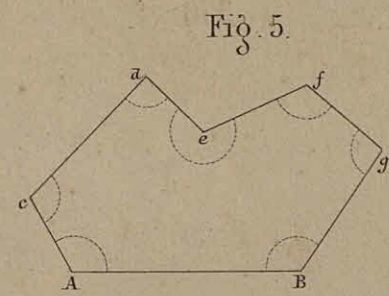
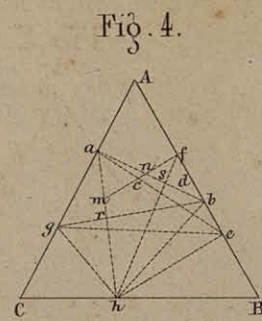
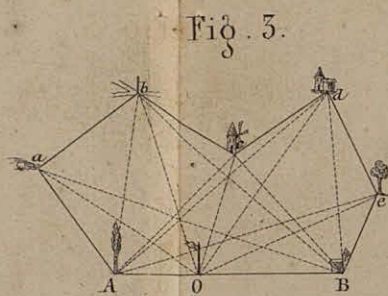
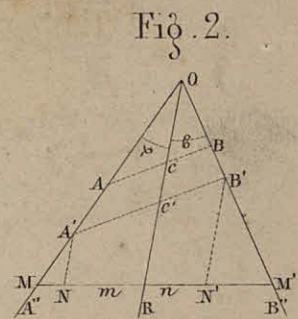
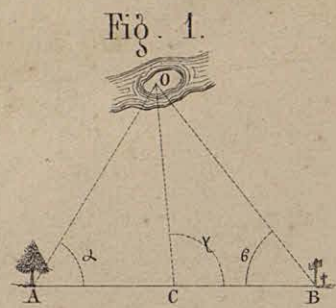

Fig. 1<sup>a</sup>

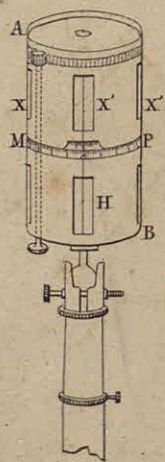

Fig. 2<sup>a</sup>

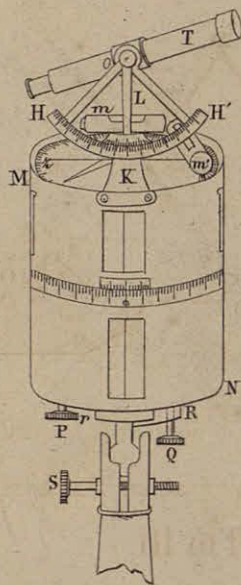

Fig. 3<sup>a</sup>

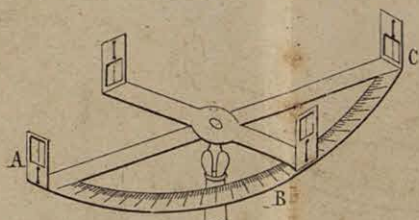

Fig. 4<sup>a</sup>

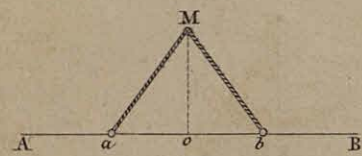

Fig. 5<sup>a</sup>

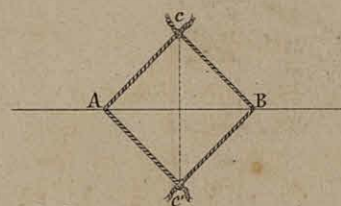

Fig. 6<sup>a</sup>

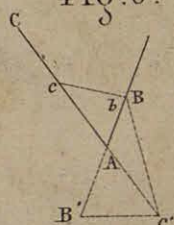

Fig. 7<sup>a</sup>

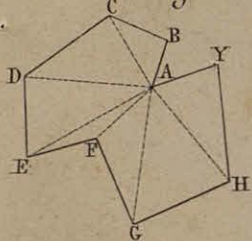

Fig. 8<sup>a</sup>

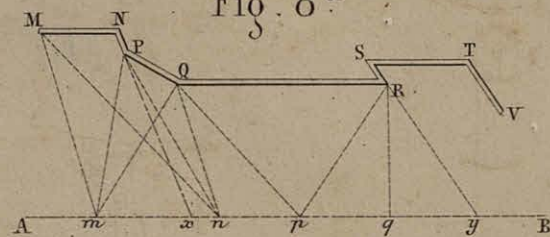

Fig. 9<sup>a</sup>

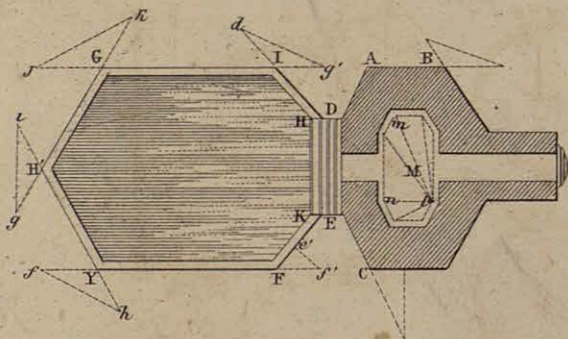

Fig. 10.

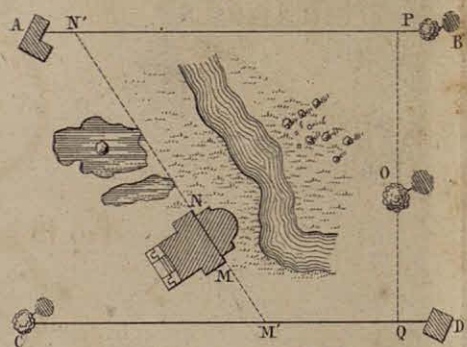

Fig. 11.

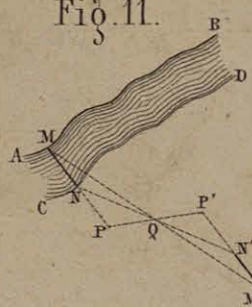

Fig. 18.



Fig. 12.

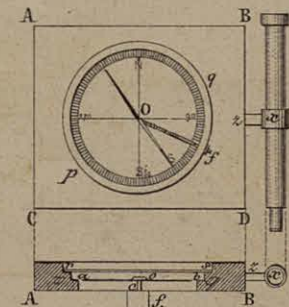

Fig. 13.

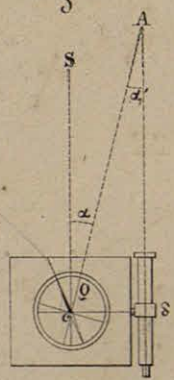

Fig. 14.

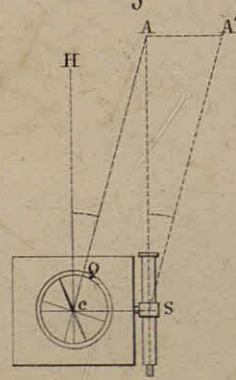

Fig. 15.



Fig. 17.

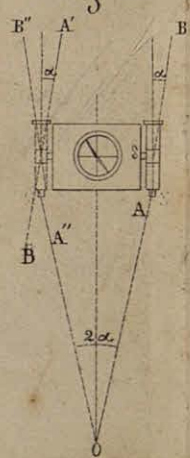

Fig. 16.

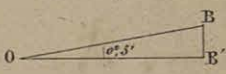

Fig. 20.

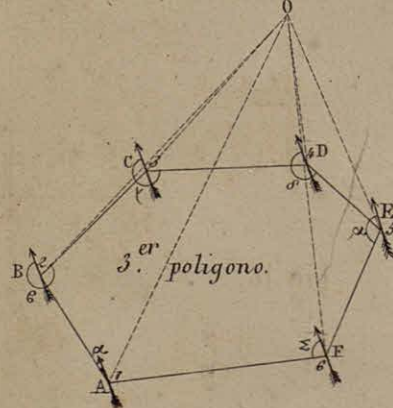

Fig. 21.

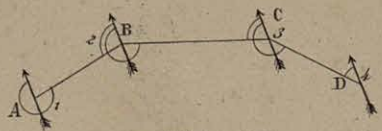

Fig. 22.

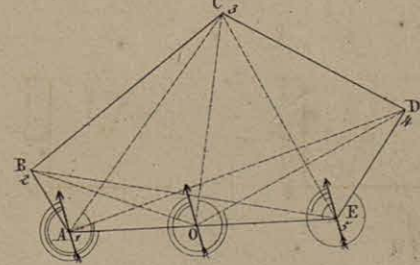

Fig. 1<sup>a</sup>

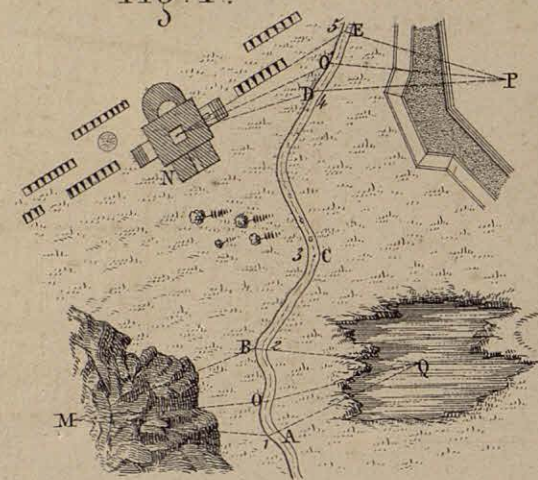

Fig. 2<sup>a</sup>

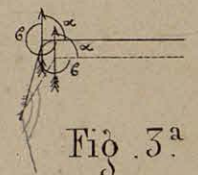

Fig. 3<sup>a</sup>

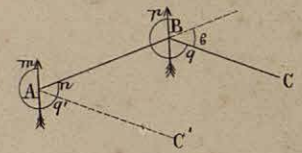

Fig. 4<sup>a</sup>

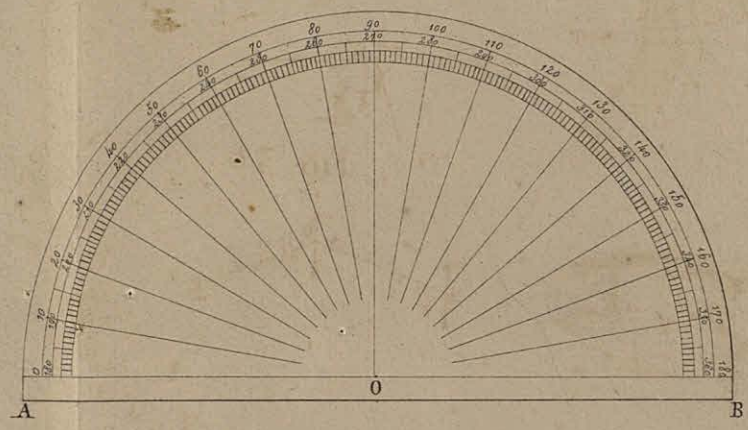

Fig. 5<sup>a</sup>

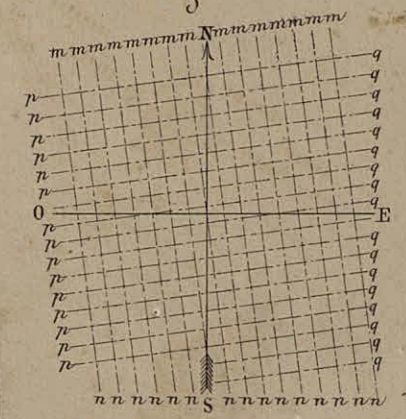

Fig. 6<sup>a</sup>

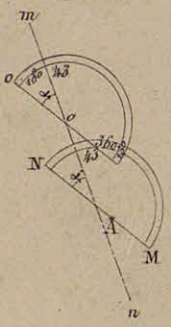

Fig. 7<sup>a</sup>

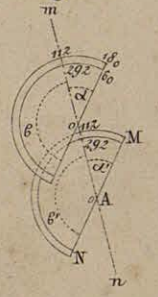

Fig. 8<sup>a</sup>

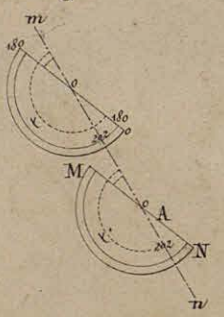

Fig. 9<sup>a</sup>

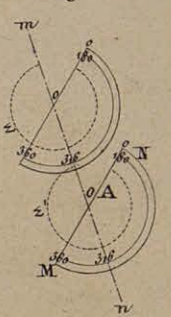

Fig. 11.

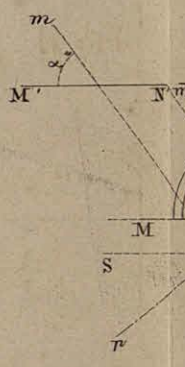

Fig. 12.

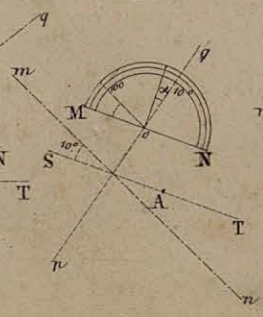

Fig. 13.

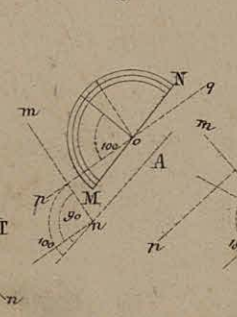

Fig. 14.

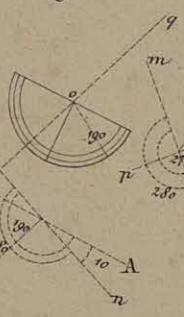

Fig. 15.

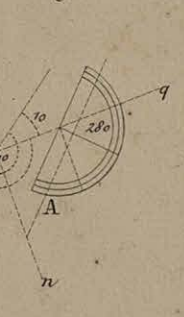

Fig. 10.

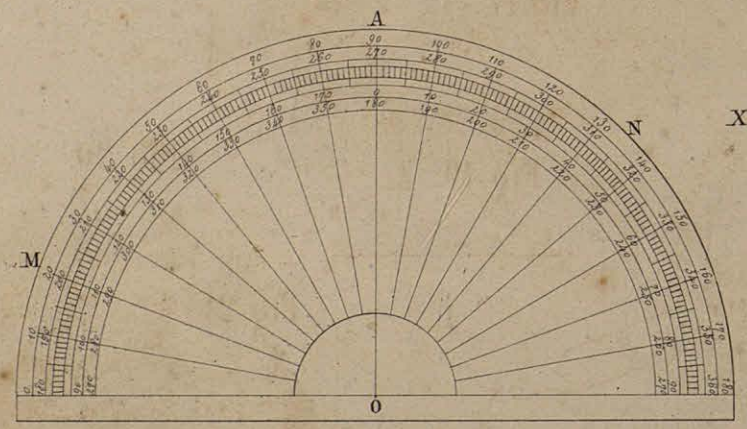

Fig. 16.

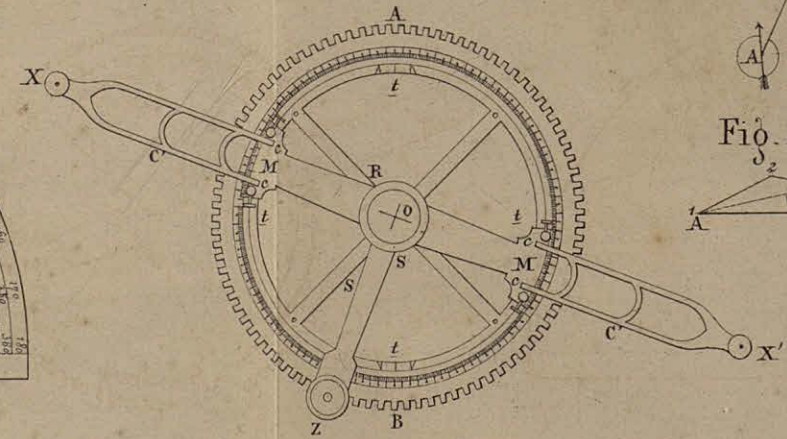

Fig. 17.

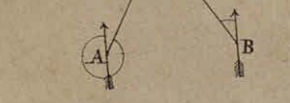

Fig. 18.

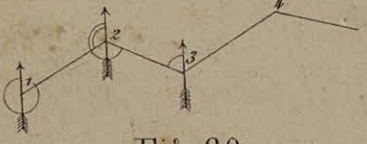

Fig. 19.

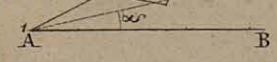

Fig. 20.

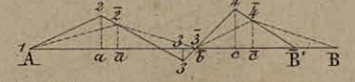

Fig. 21.

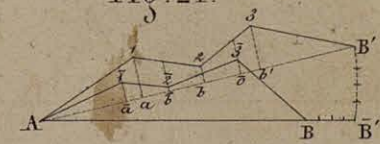

Fig. 1.

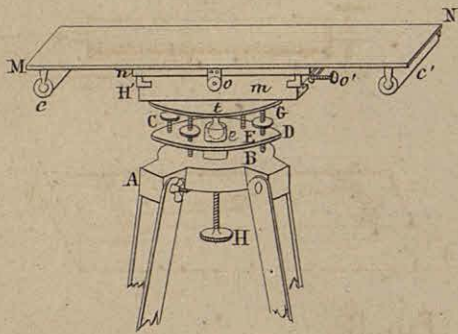

Fig. 1 bis.

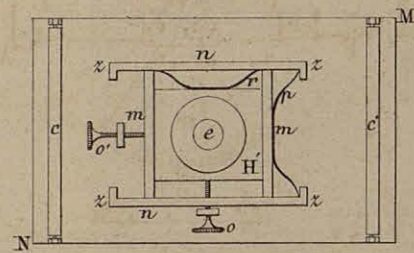

Fig. 2.

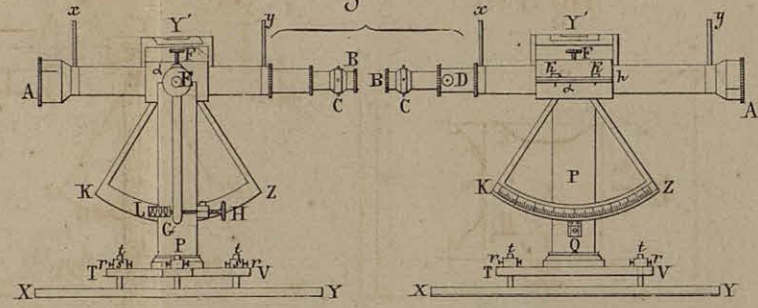

Fig. 3.



Fig. 4.

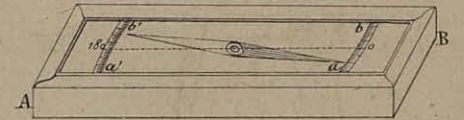

Fig. 6.

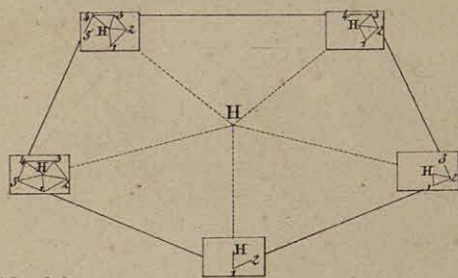

Fig. 7.

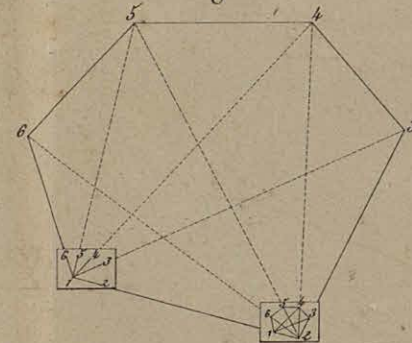

Fig. 8.

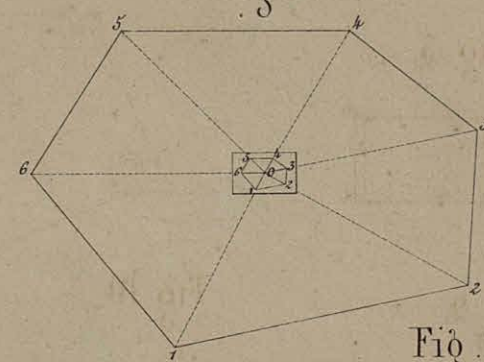

Fig. 5.

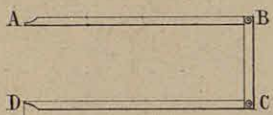

Fig. 9.

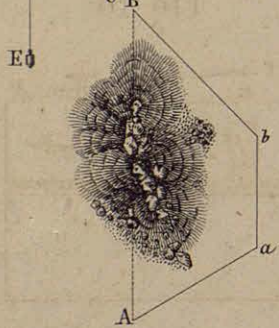

Fig. 10.

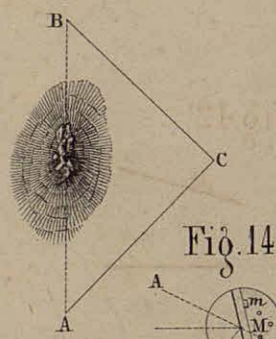

Fig. 11.

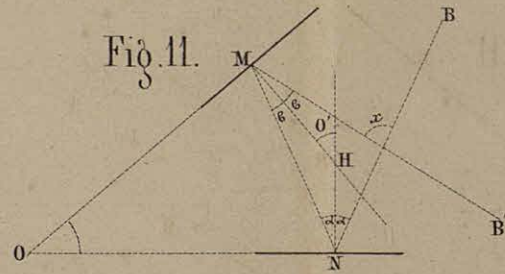

Fig. 12.

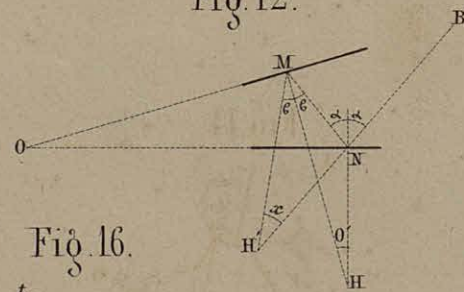

Fig. 18.

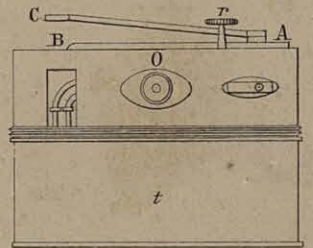

Fig. 14.

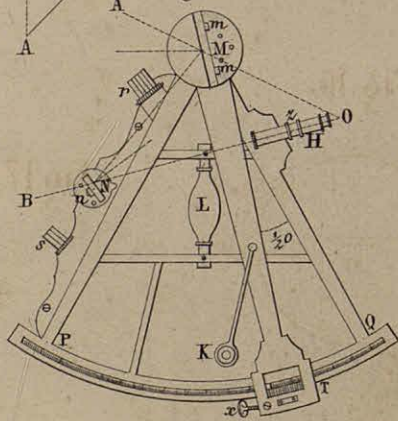

Fig. 15.

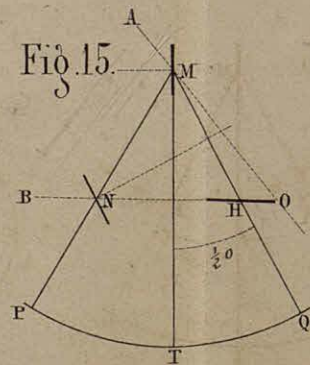

Fig. 16.

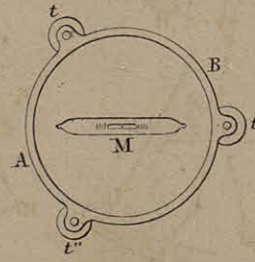

Fig. 17.

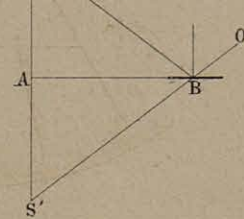

Fig. 13.

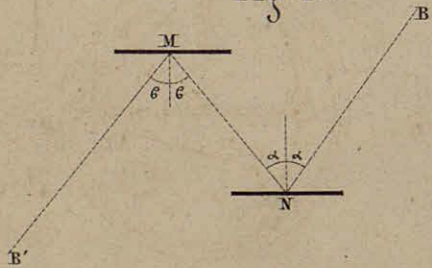

Fig. 1.

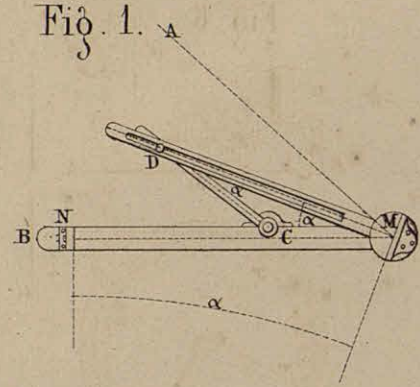

Fig. 2.

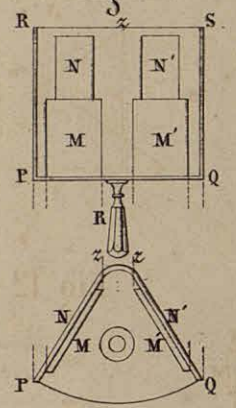

Fig. 3.

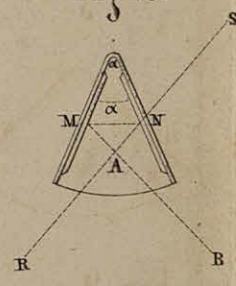

Fig. 4.

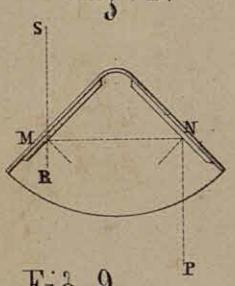

Fig. 5.

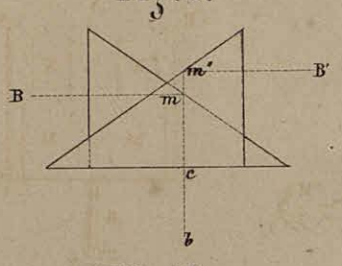

Fig. 6.

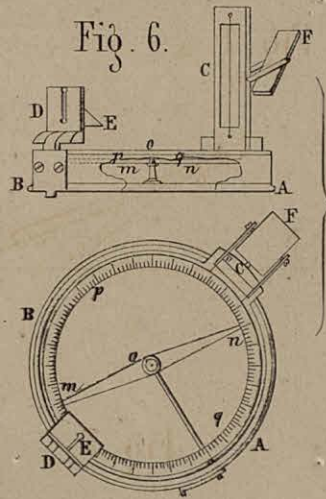

Fig. 7.

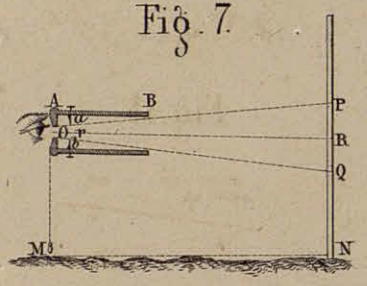

Fig. 8.

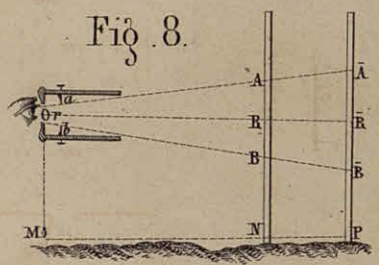

Fig. 9.

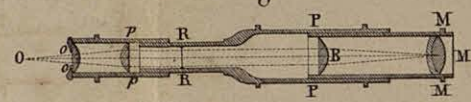

Fig. 10.

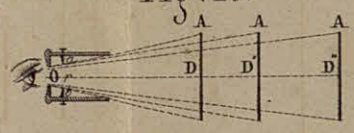

Fig. 11.

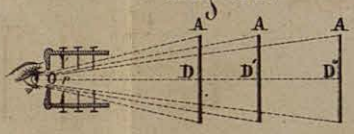

Fig. 12.

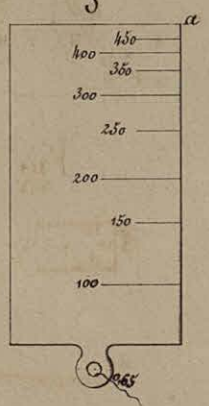

Fig. 14.

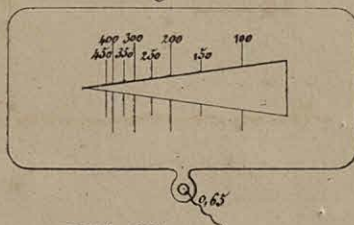

Fig. 15.

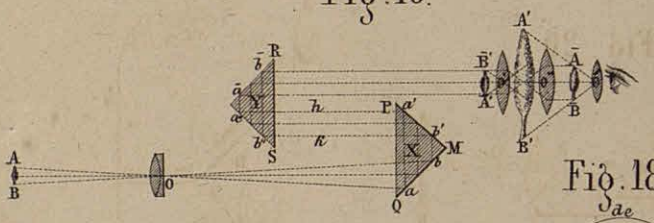

Fig. 18.

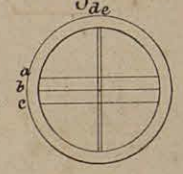

Fig. 17.

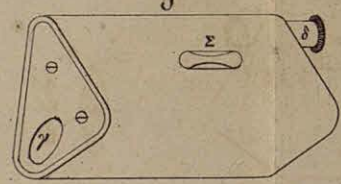

Fig. 20.

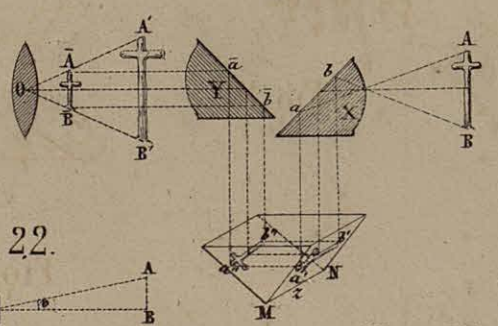

Fig. 16.

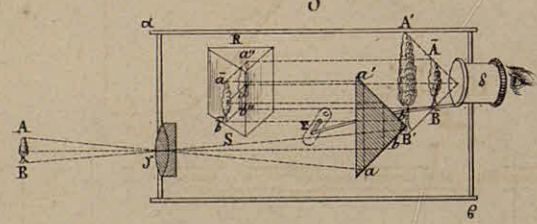

Fig. 19.



Fig. 22.

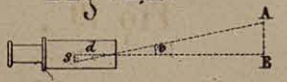

Fig. 21.

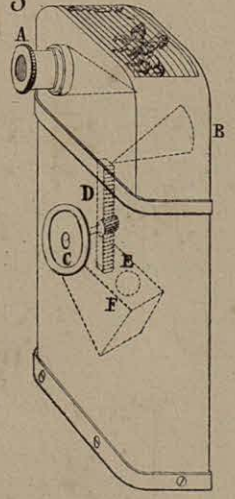

Fig. 23.

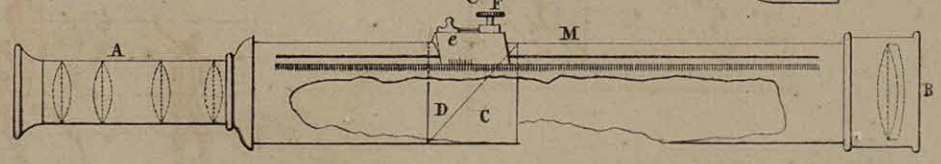



Fig. 1.

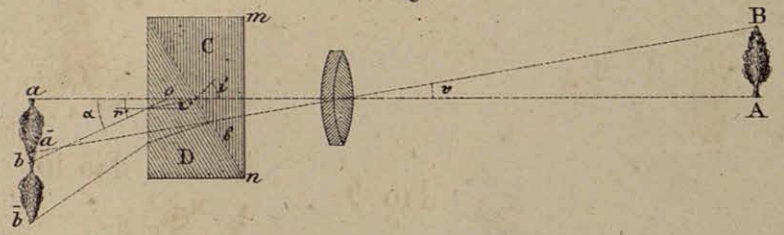

Fig. 2.

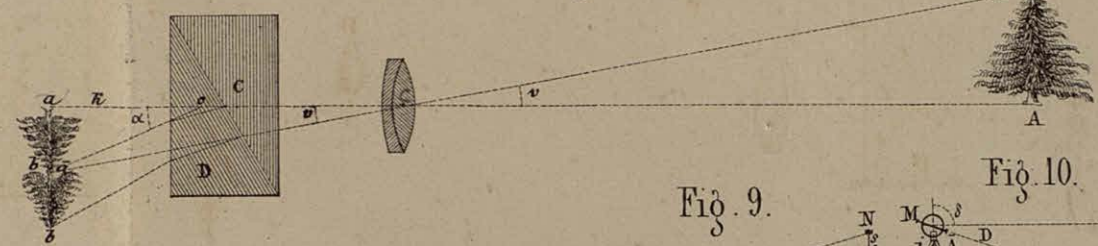

Fig. 3.

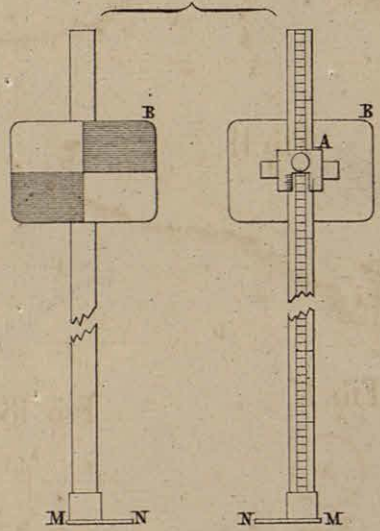

Fig. 4.

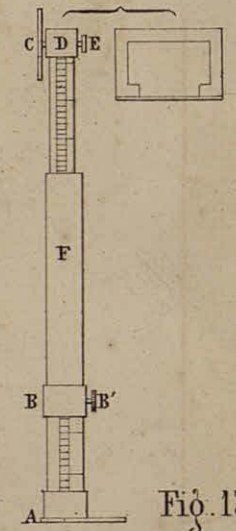

Fig. 5.



Fig. 6.



Fig. 7.



Fig. 8.

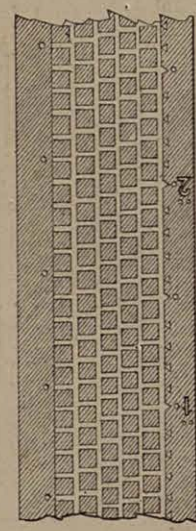

Fig. 9.

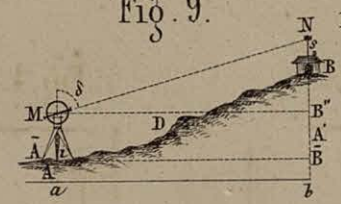

Fig. 10.

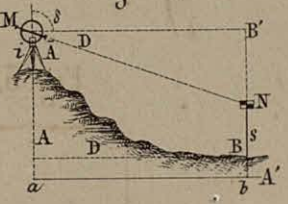

Fig. 11.

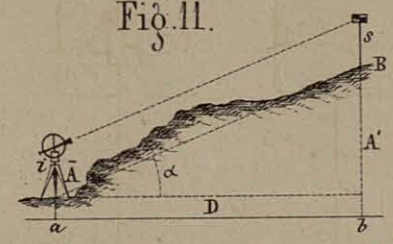

Fig. 17.

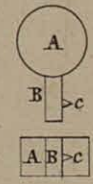

Fig. 18.

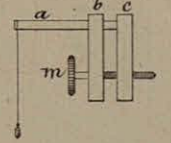

Fig. 12.

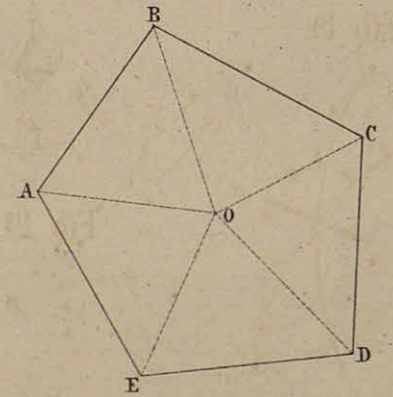

Fig. 13.

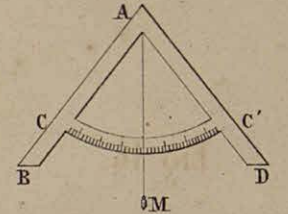

Fig. 14.

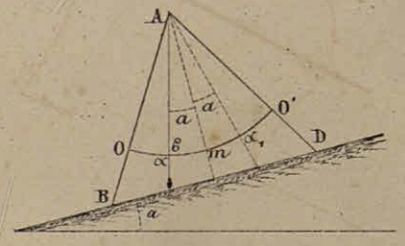

Fig. 15.

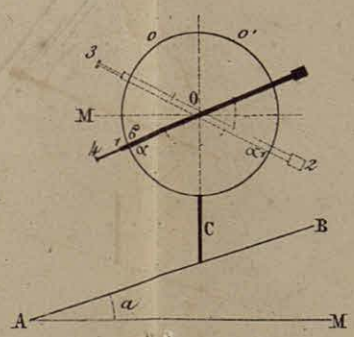

Fig. 16.

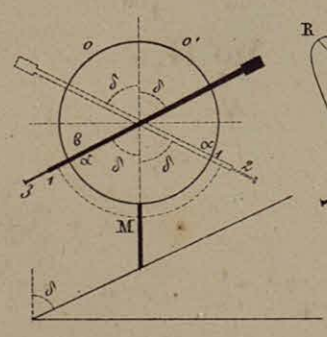

Fig. 19.

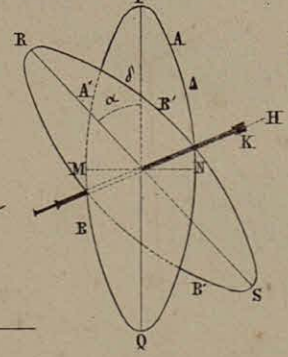

Fig. 20.

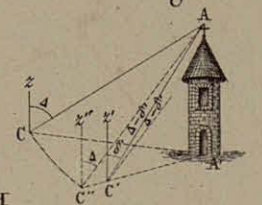
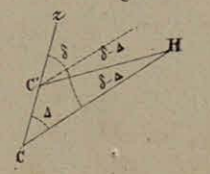

Fig. 21.



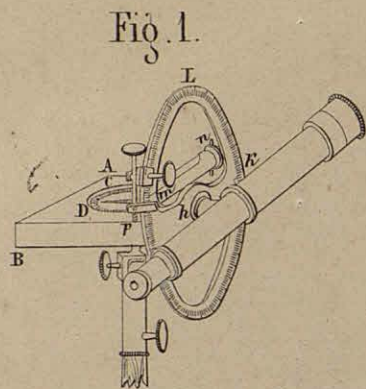

Fig. 1.

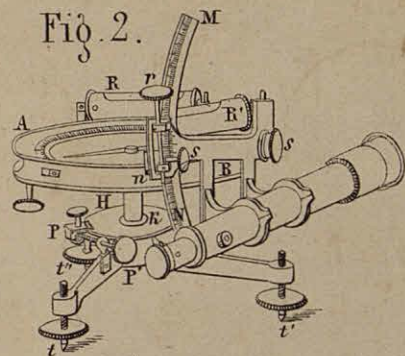

Fig. 2.

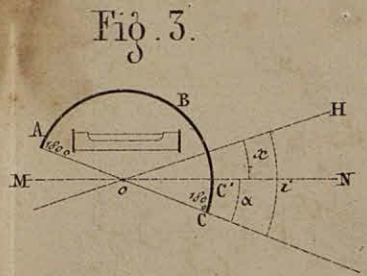

Fig. 3.

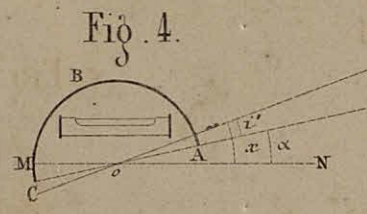

Fig. 4.

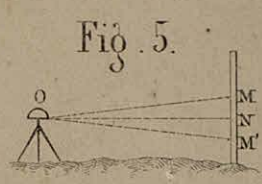

Fig. 5.



Fig. 6.

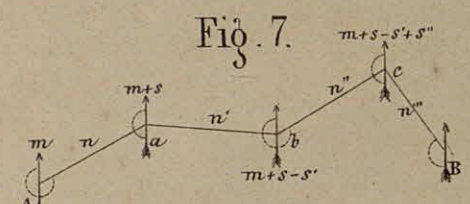

Fig. 7.

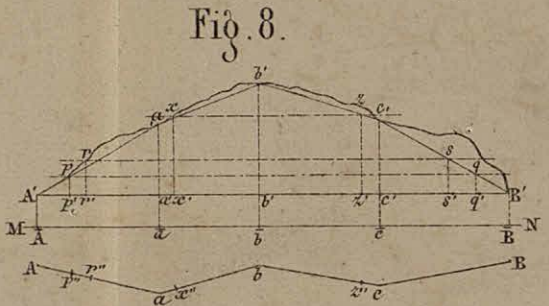

Fig. 8.

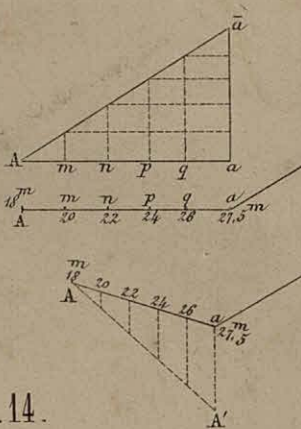

Fig. 9.

Fig. 10.

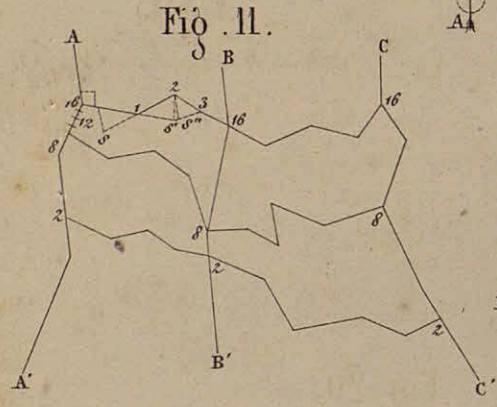

Fig. 11.

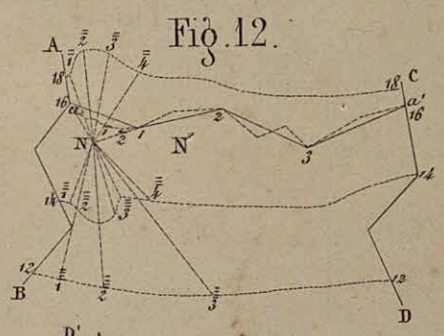

Fig. 12.

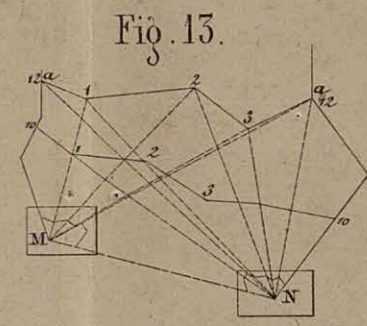

Fig. 13.

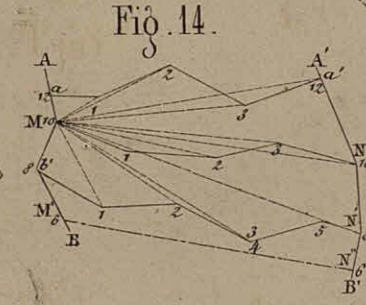

Fig. 14.

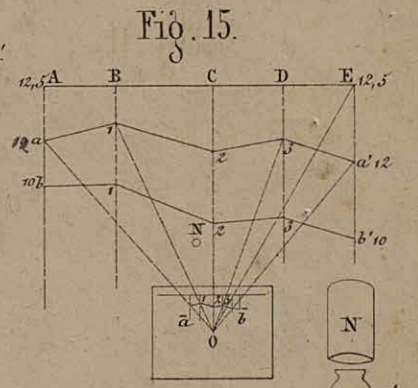

Fig. 15.

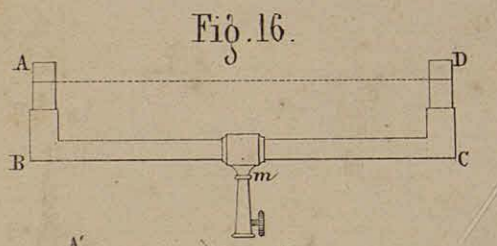

Fig. 16.

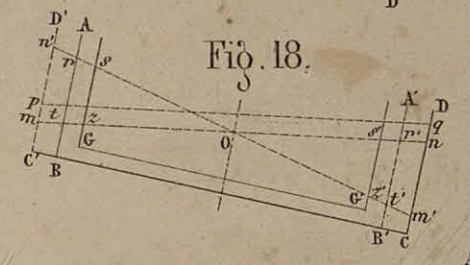

Fig. 18.

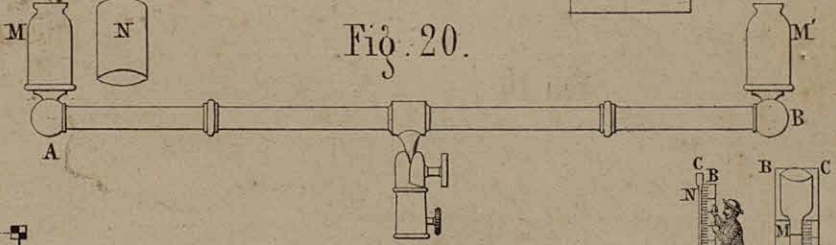

Fig. 20.

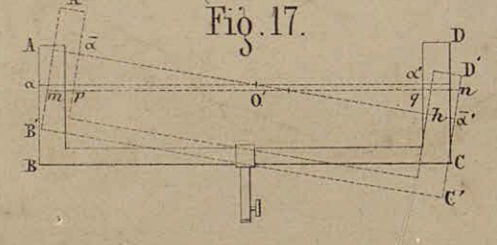

Fig. 17.

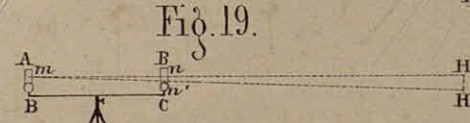

Fig. 19.

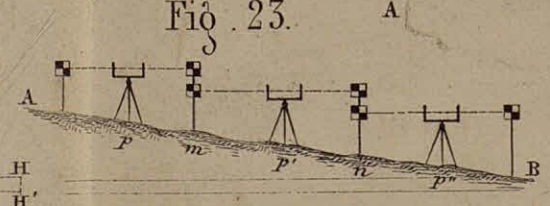

Fig. 23.

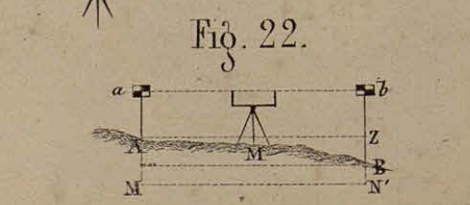

Fig. 22.

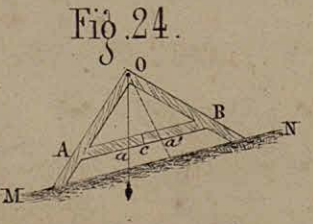

Fig. 24.

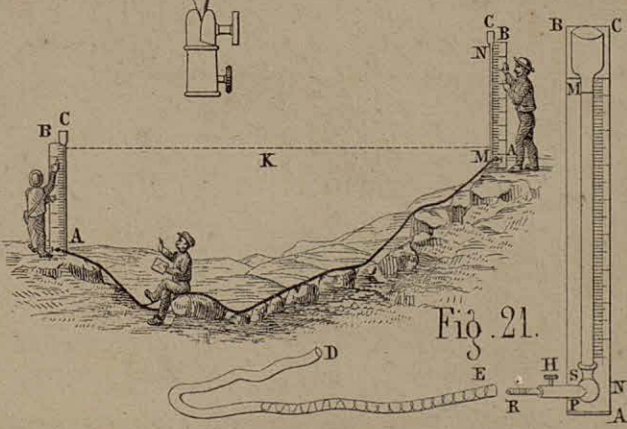

Fig. 21.

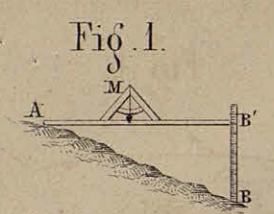

Fig. 1.

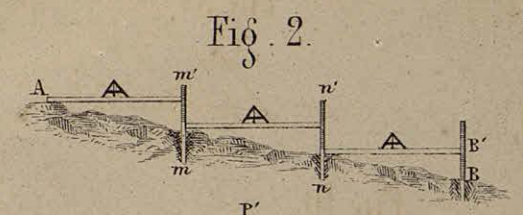

Fig. 2.

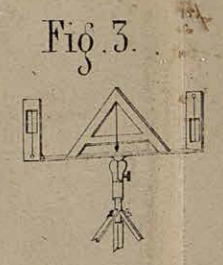

Fig. 3.

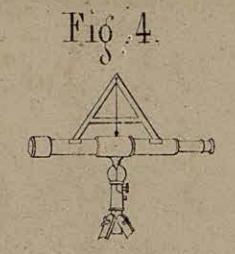

Fig. 4.

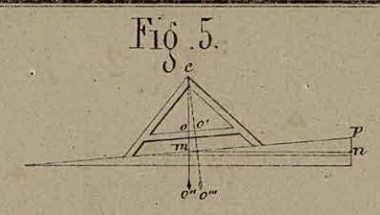

Fig. 5.

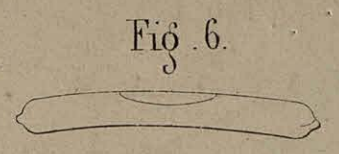

Fig. 6.

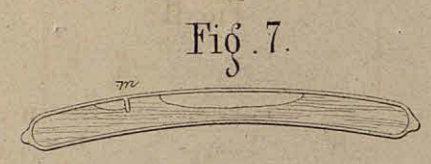

Fig. 7.

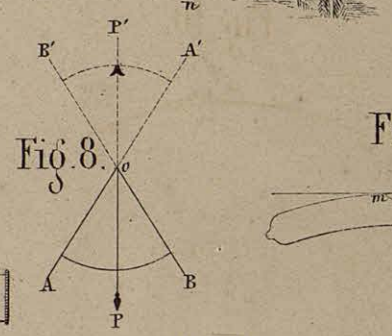

Fig. 8.

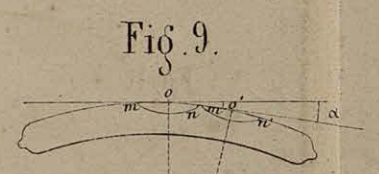

Fig. 9.

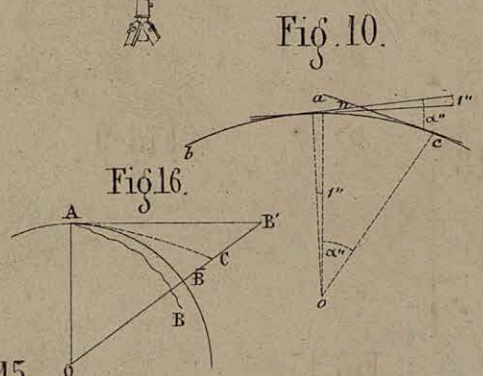

Fig. 10.

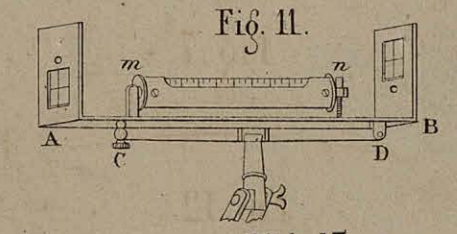

Fig. 11.

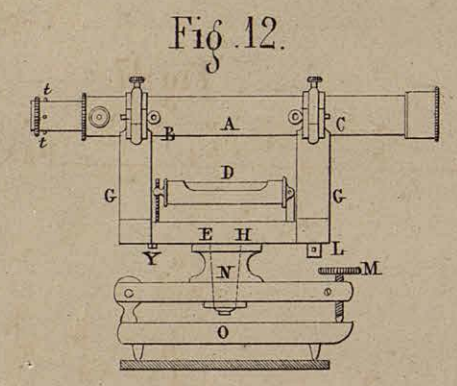

Fig. 12.

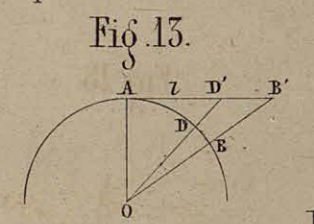

Fig. 13.

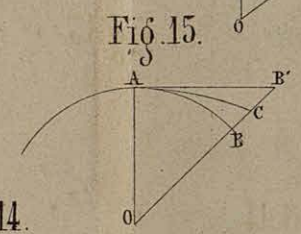

Fig. 14.

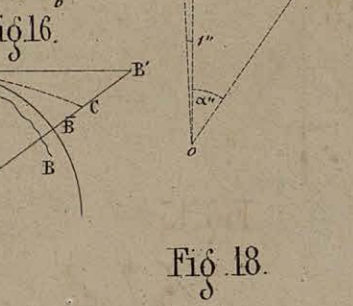

Fig. 15.

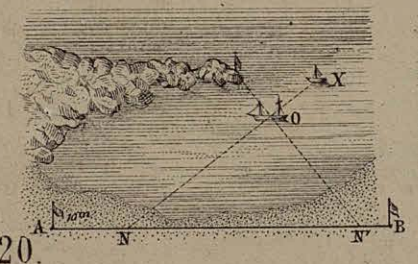

Fig. 16.

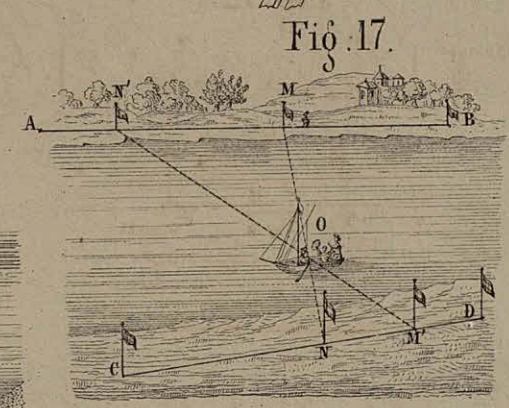

Fig. 17.

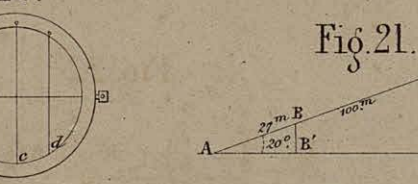

Fig. 18.

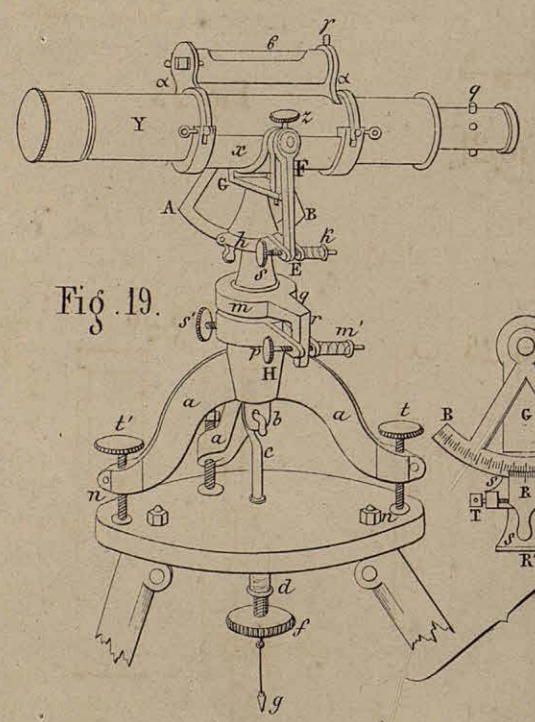

Fig. 19.

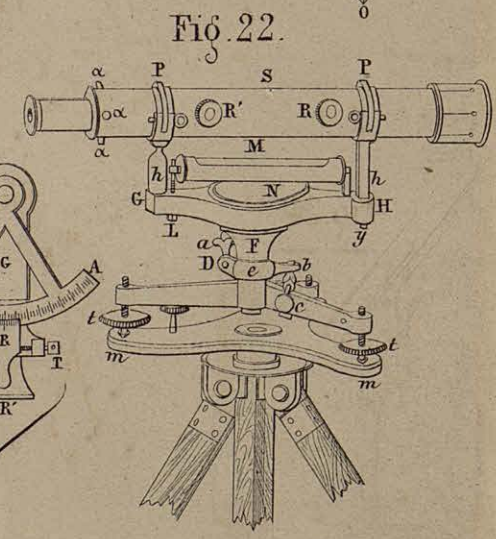

Fig. 20.

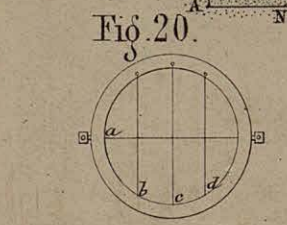

Fig. 21.

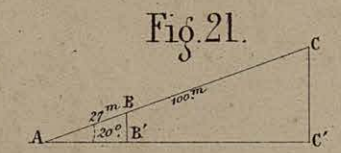

Fig. 22.

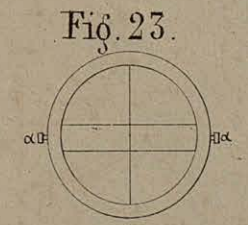

Fig. 23.

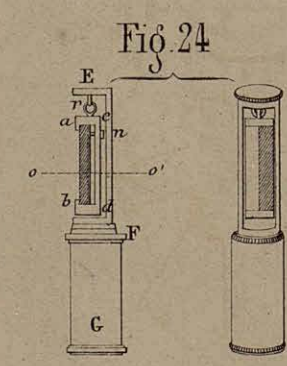

Fig. 24.

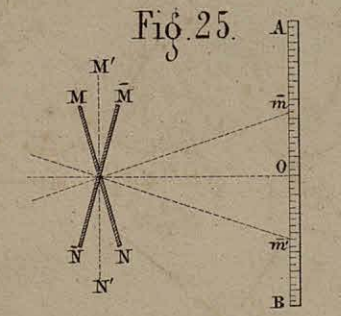

Fig. 25.

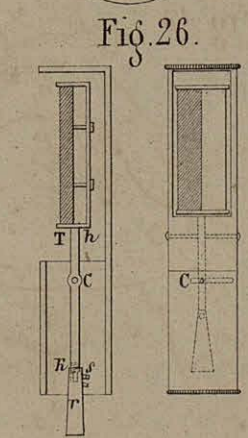

Fig. 26.

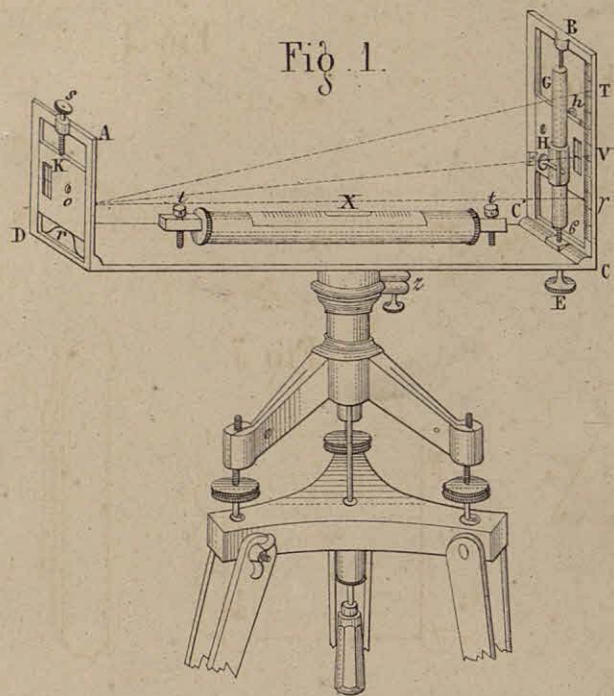

Fig. 1.

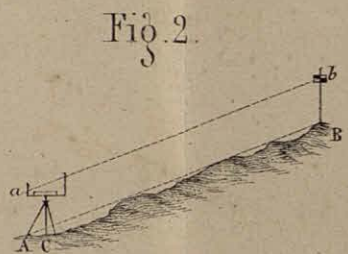

Fig. 2.

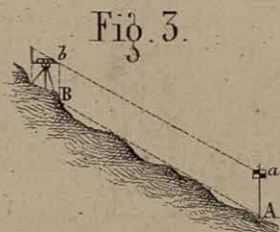

Fig. 3.

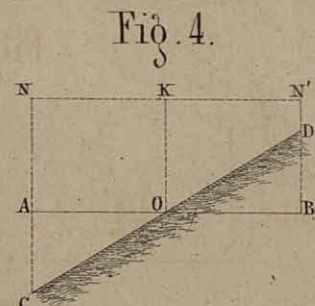

Fig. 4.

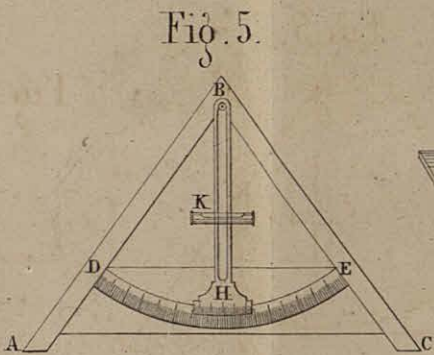

Fig. 5.

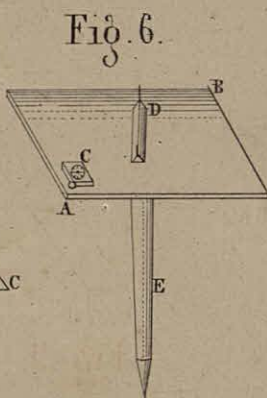

Fig. 6.

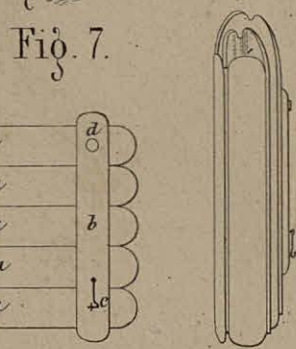

Fig. 7.

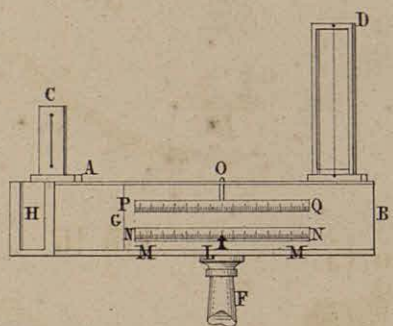

Fig. 9.

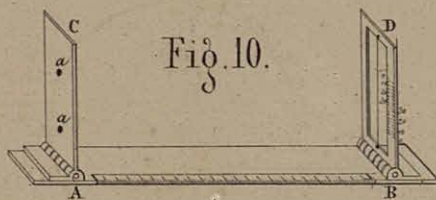
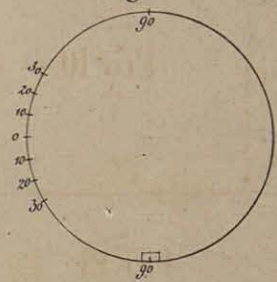

Fig. 10.

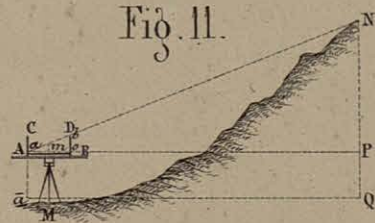

Fig. 11.

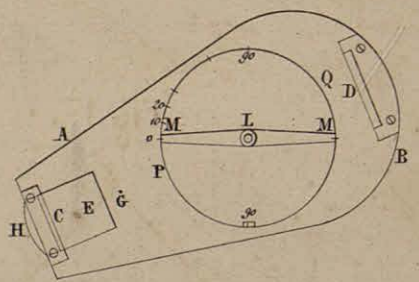

Fig. 8.

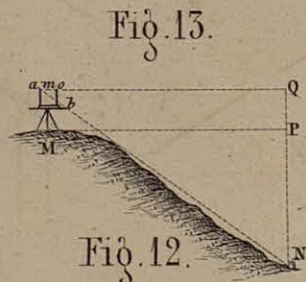
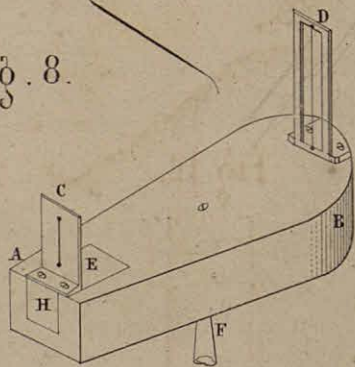

Fig. 12.



Fig. 15.

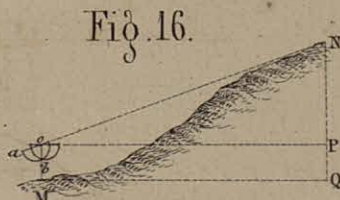

Fig. 16.

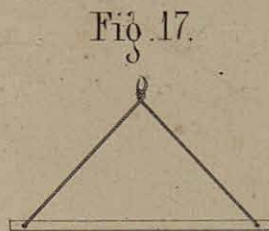

Fig. 17.

Fig. 1.



Fig. 2.

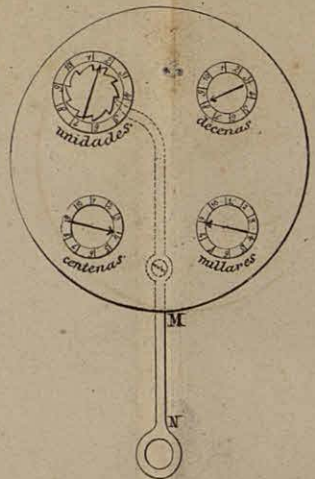

Fig. 3.

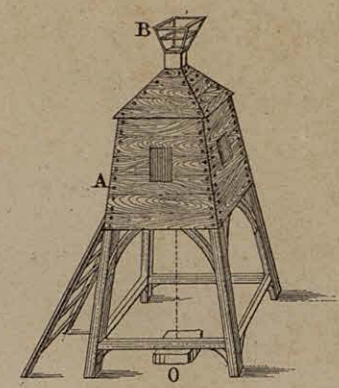

Fig. 4.



Fig. 9.

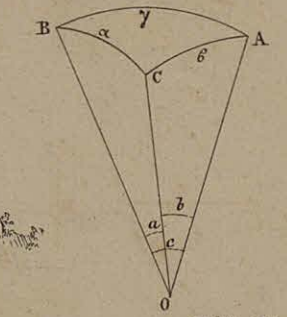

Fig. 7.

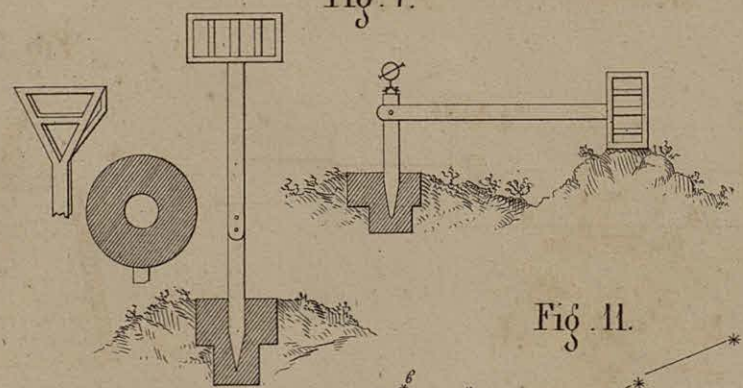

Fig. 5.

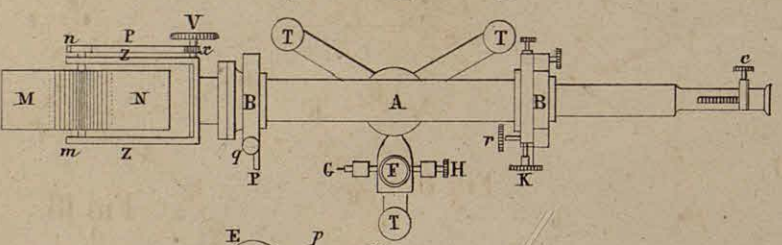
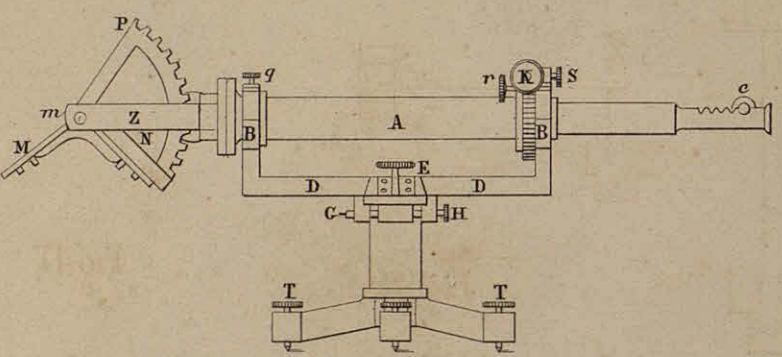
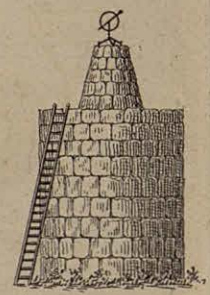

Fig. 11.

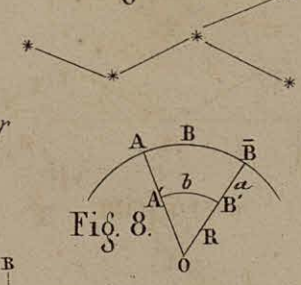

Fig. 17.

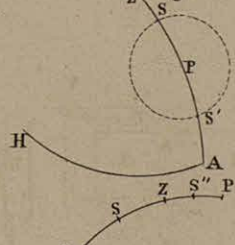

Fig. 13.

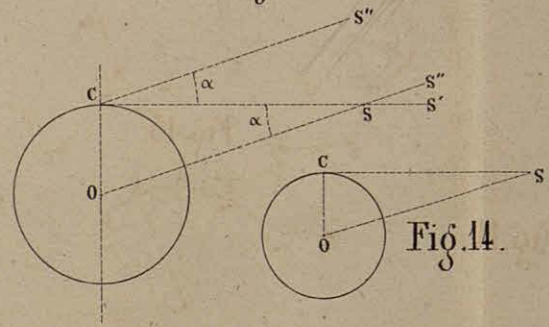

Fig. 10.

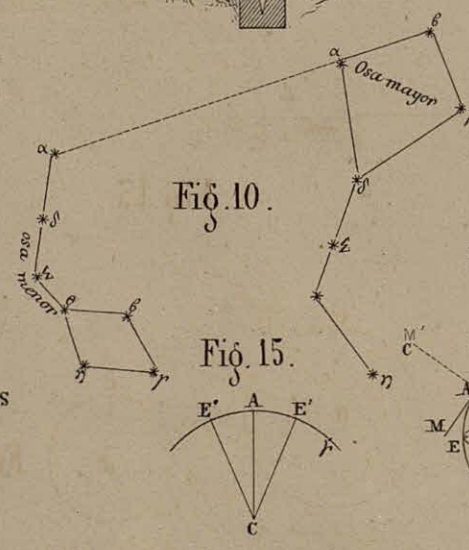

Fig. 8.

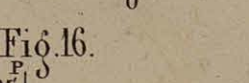

Fig. 18.



Fig. 12.

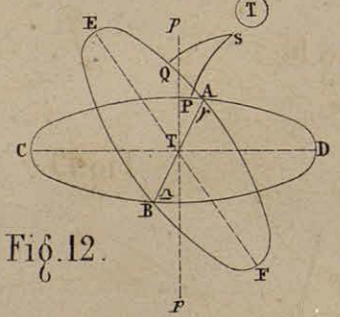

Fig. 15.

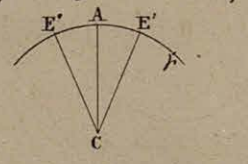

Fig. 16.

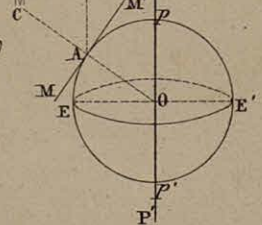

Fig. 19.

