

COMBINATÒRIA 02A C02. Coberta plana invertida transitable d'ús privat i solat flotant DANOLOSA
 F2. Sistema de façana ventilada de full interior AQUAPANEL W311 i protecció solar de lames fixes

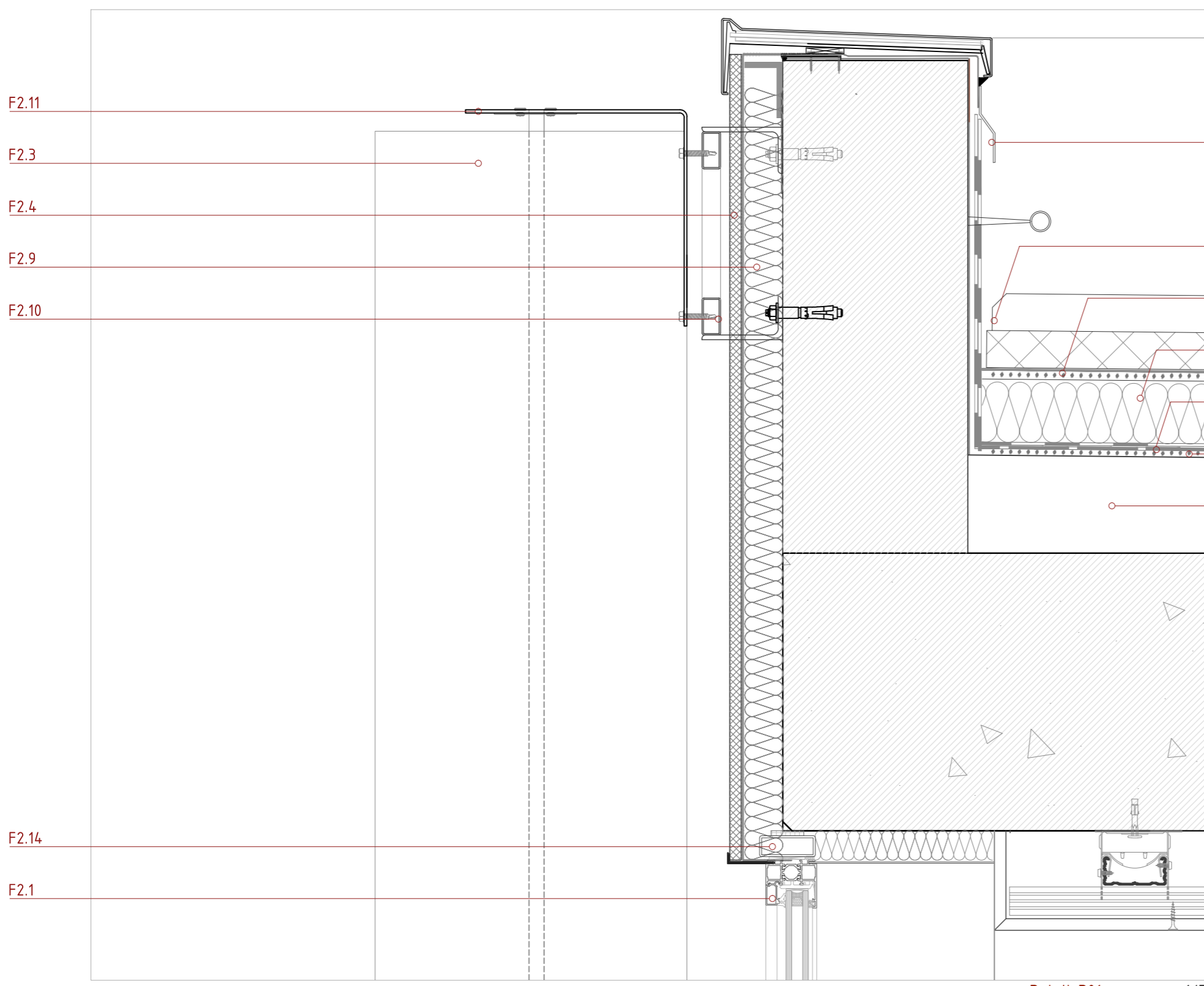

Detall D01 e. 1/5

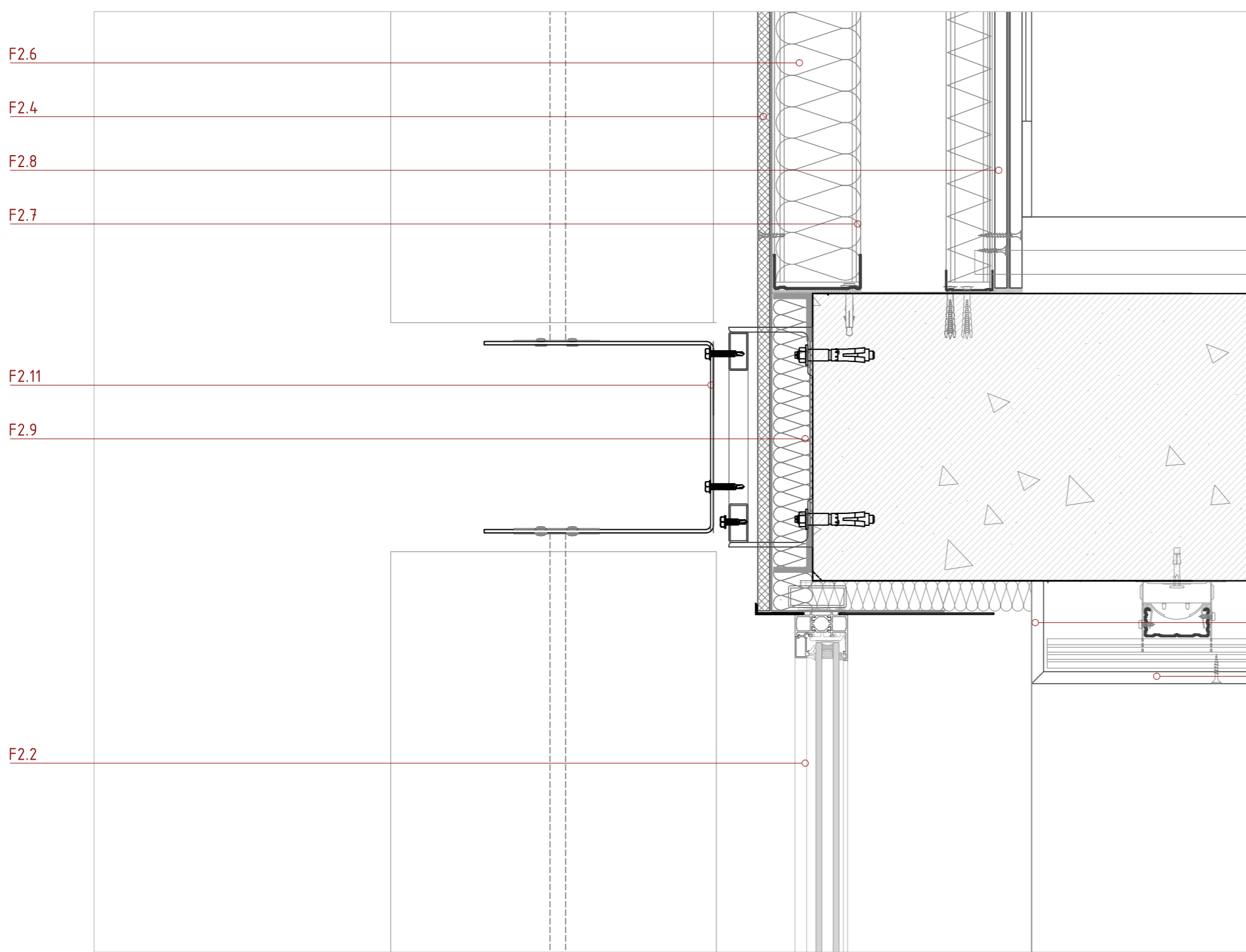

Detall D02 e. 1/5

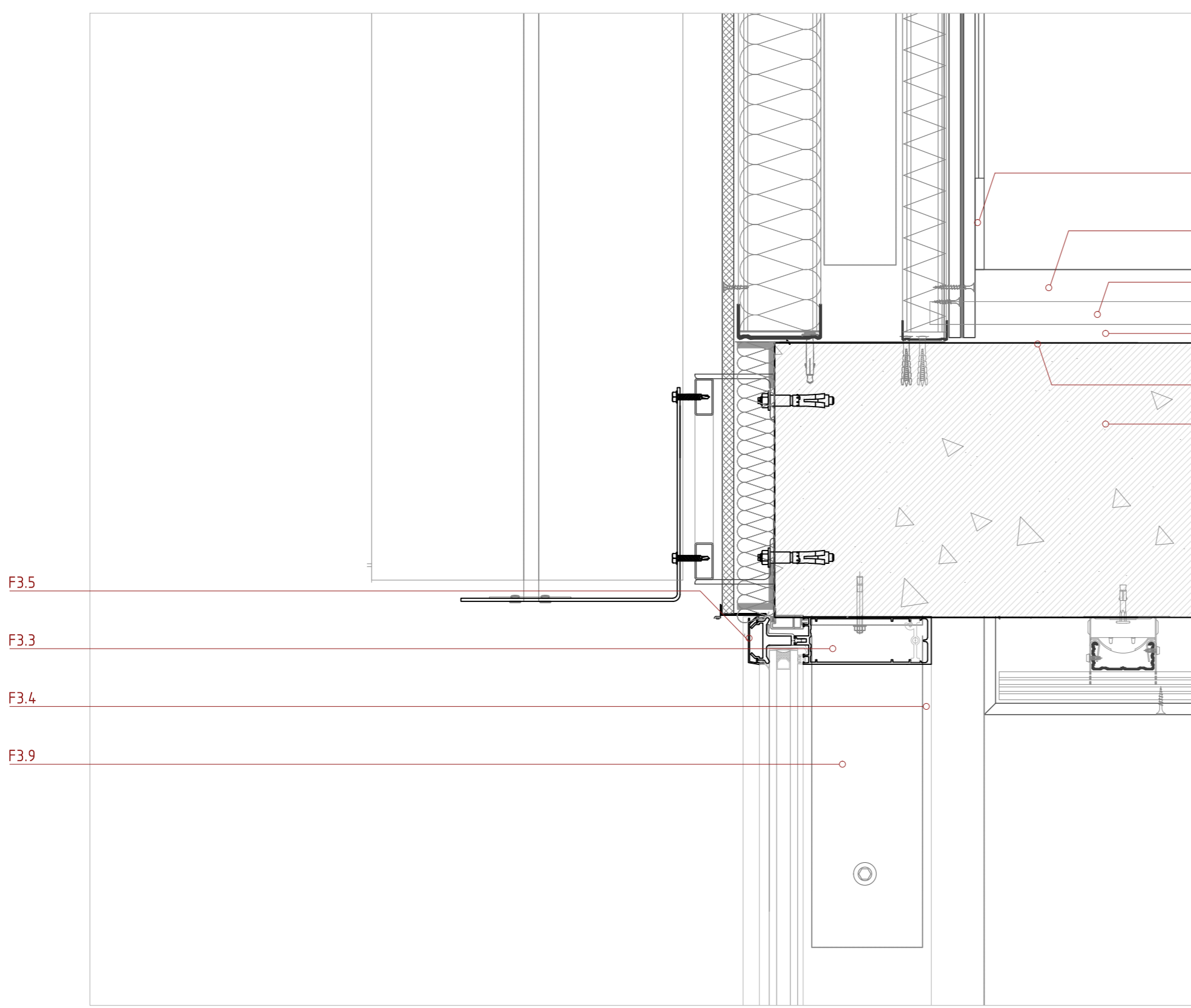

Detall D03 e. 1/5

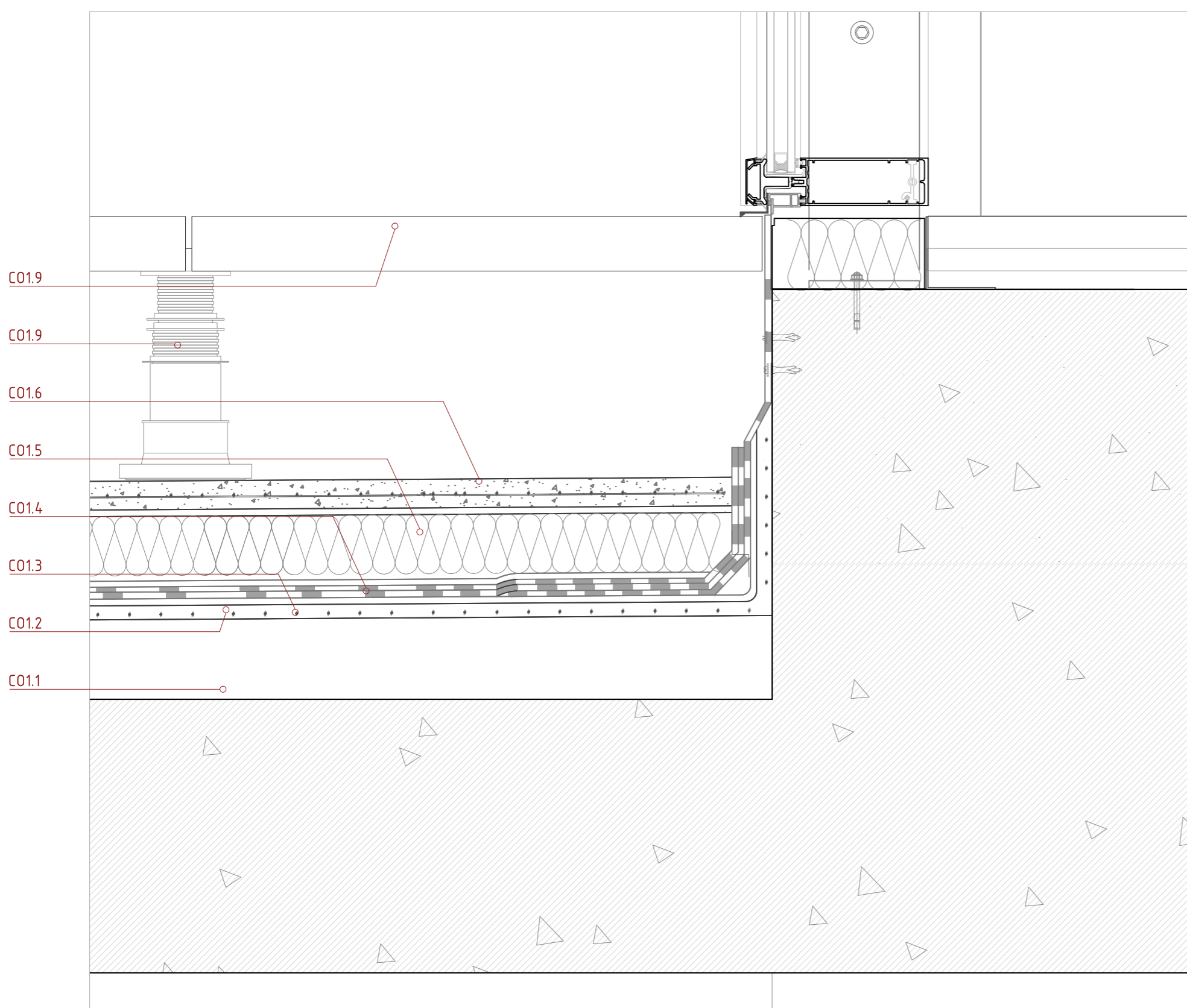

Detall D04 e. 1/5

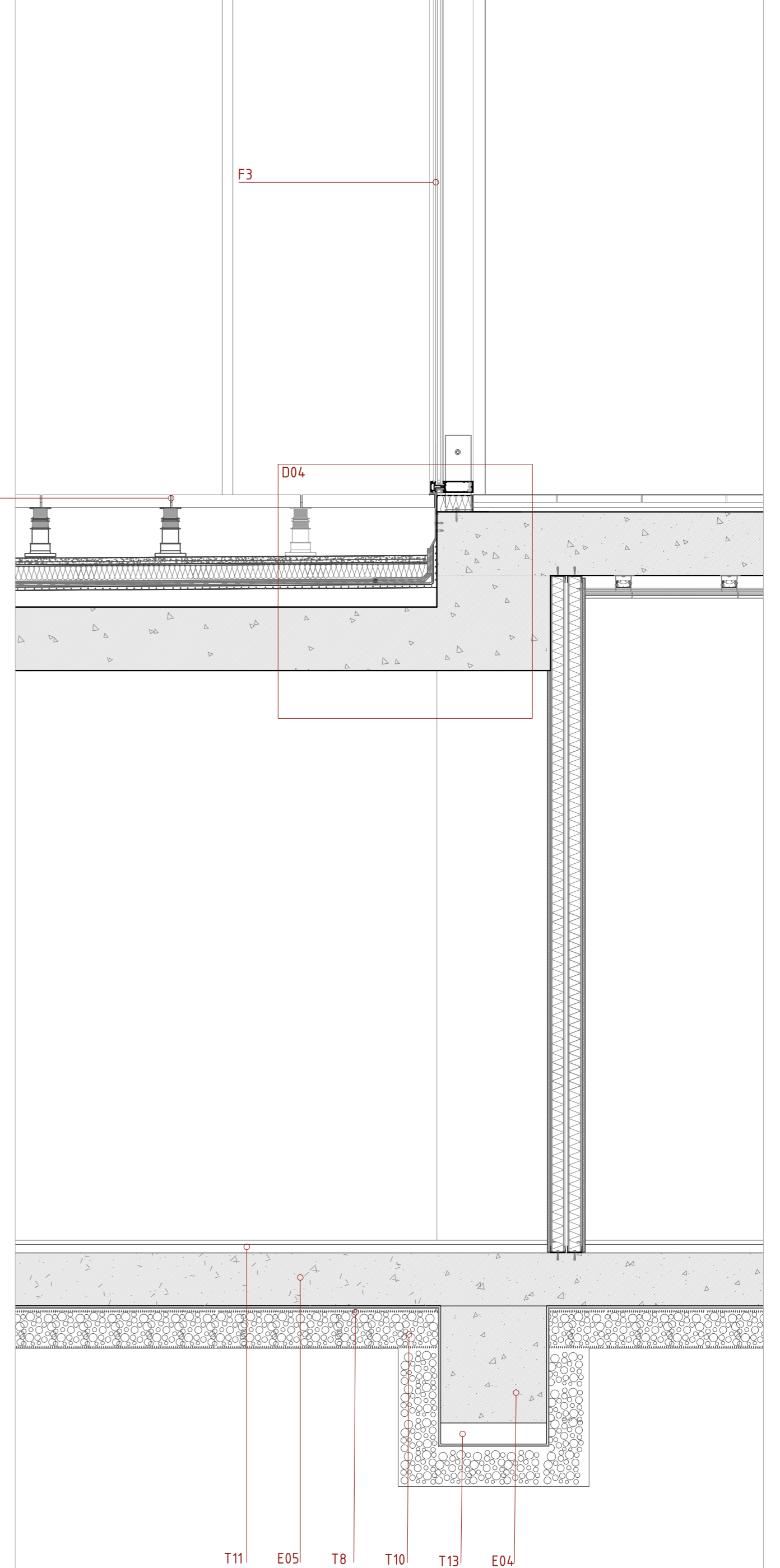
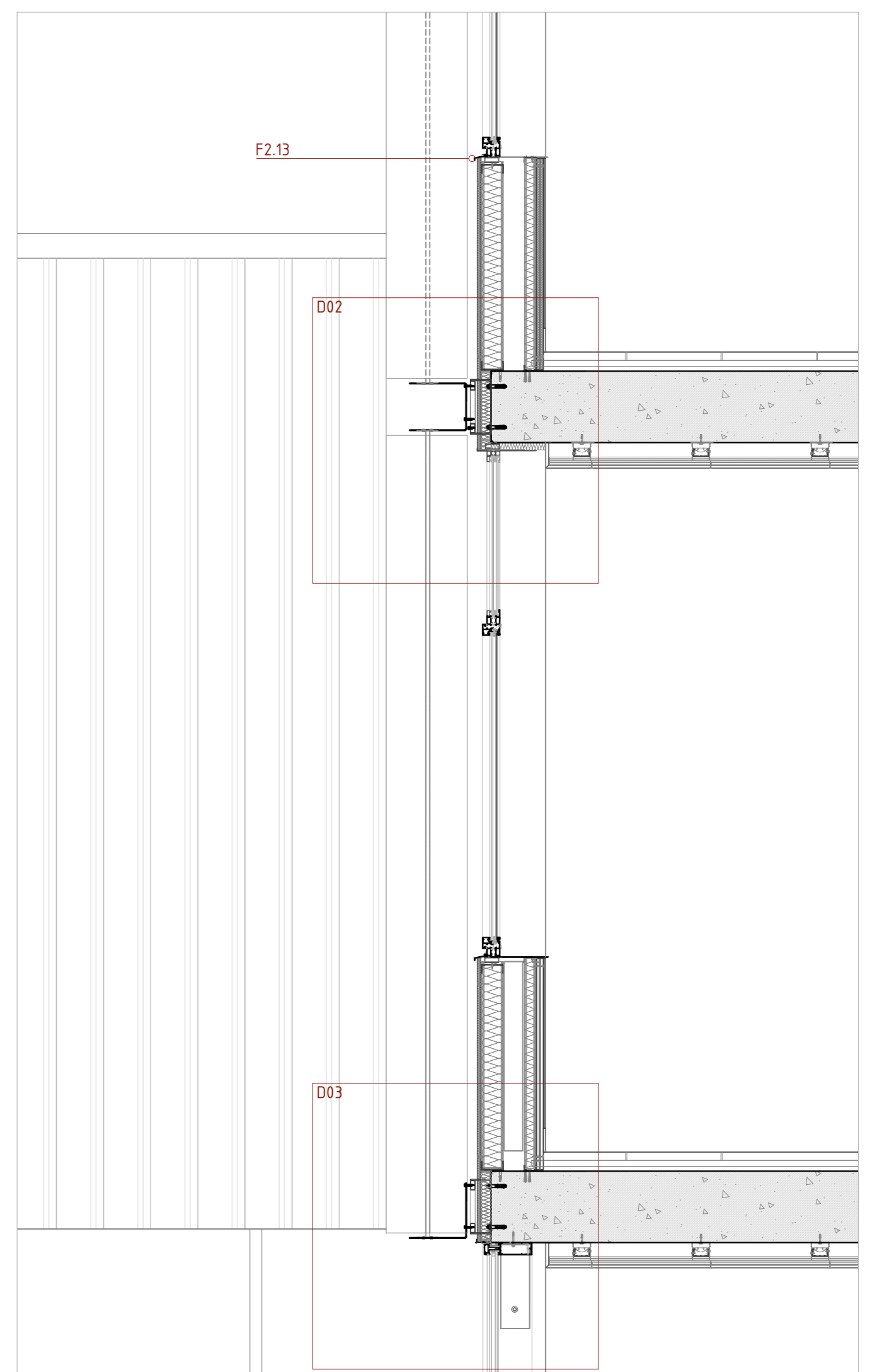
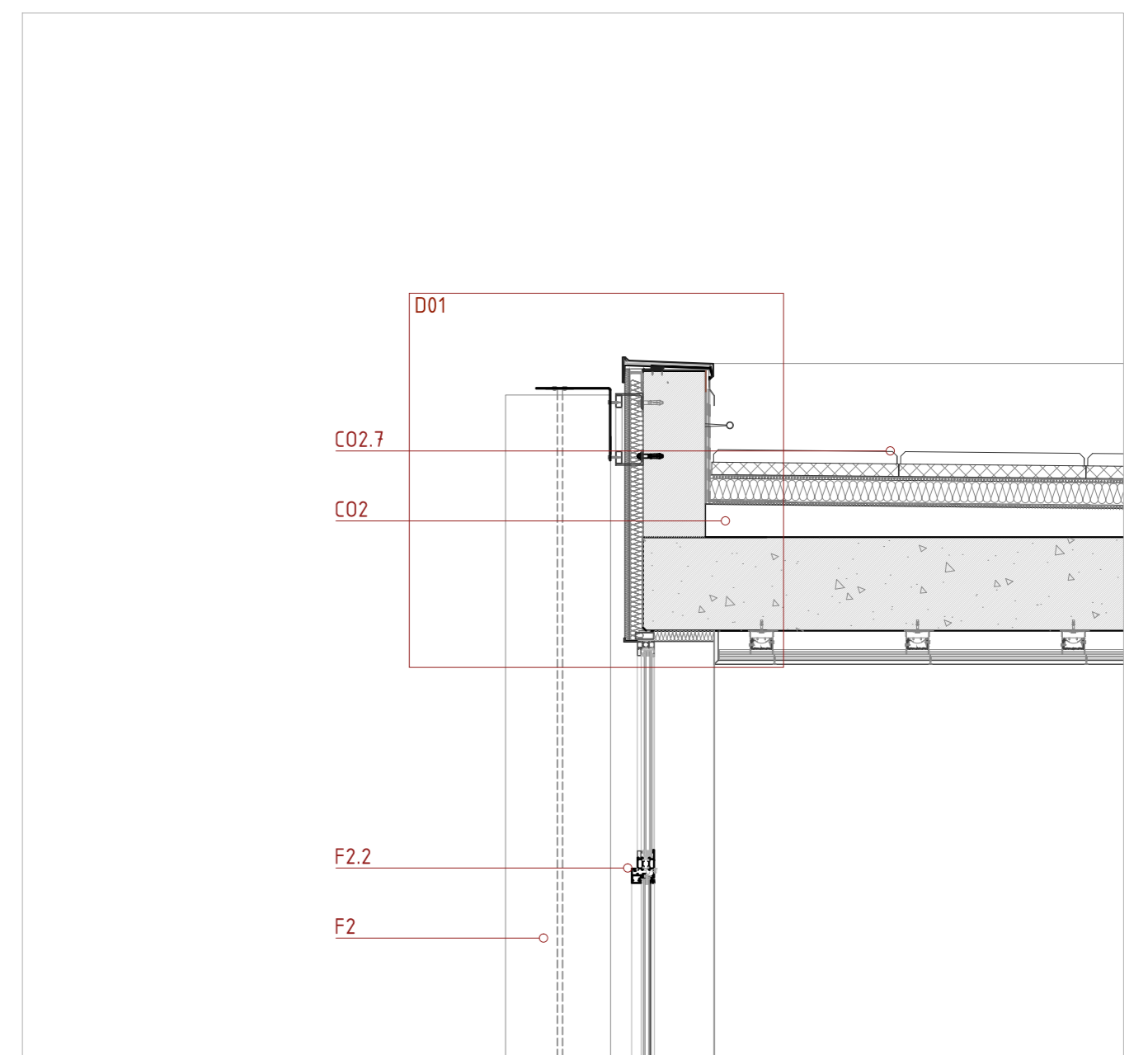

Secció vertical e. 1/20