

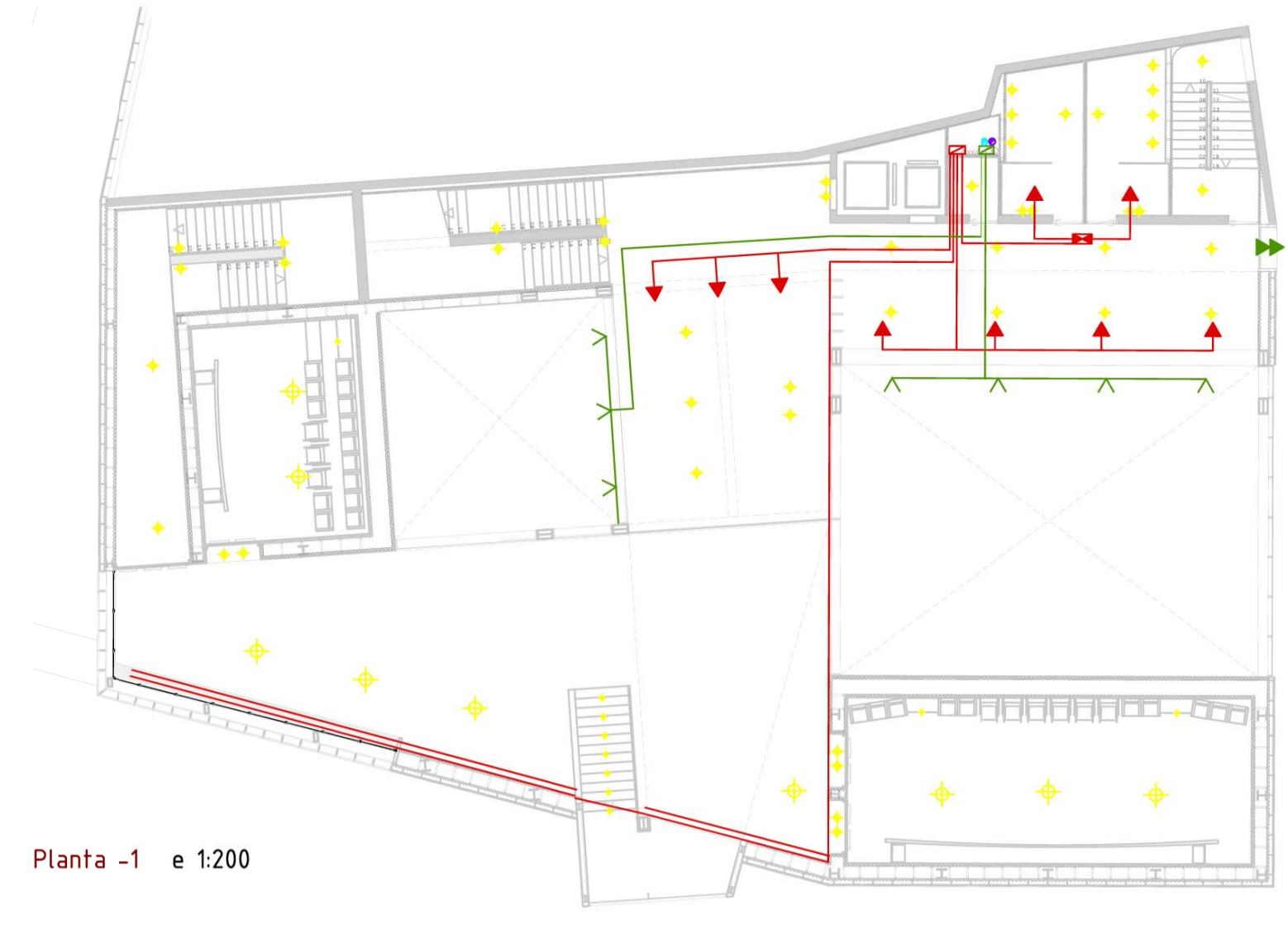

P. baja e 1:200



Planta -1 e 1:200



tipo de iluminaria

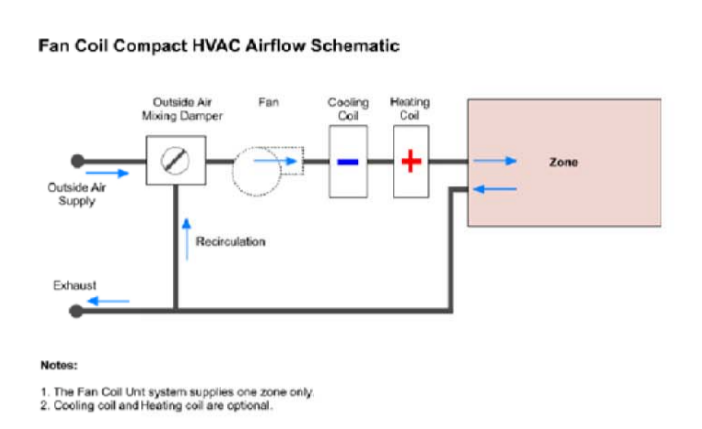

Notes:  
 1. The Fan Coil Unit requires one zone only.  
 2. Cooling and heating coil are optional.

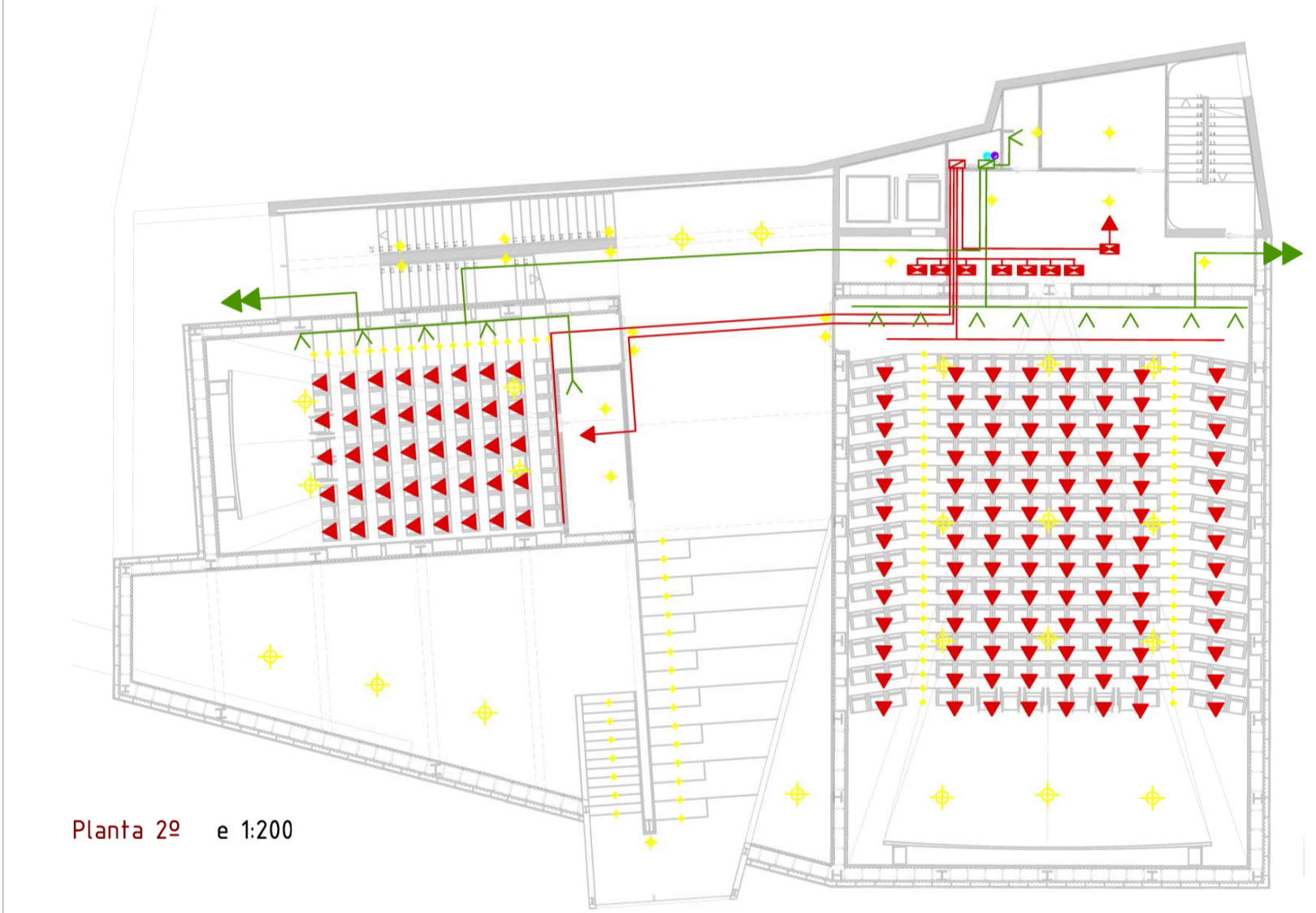

Planta 2º e 1:200

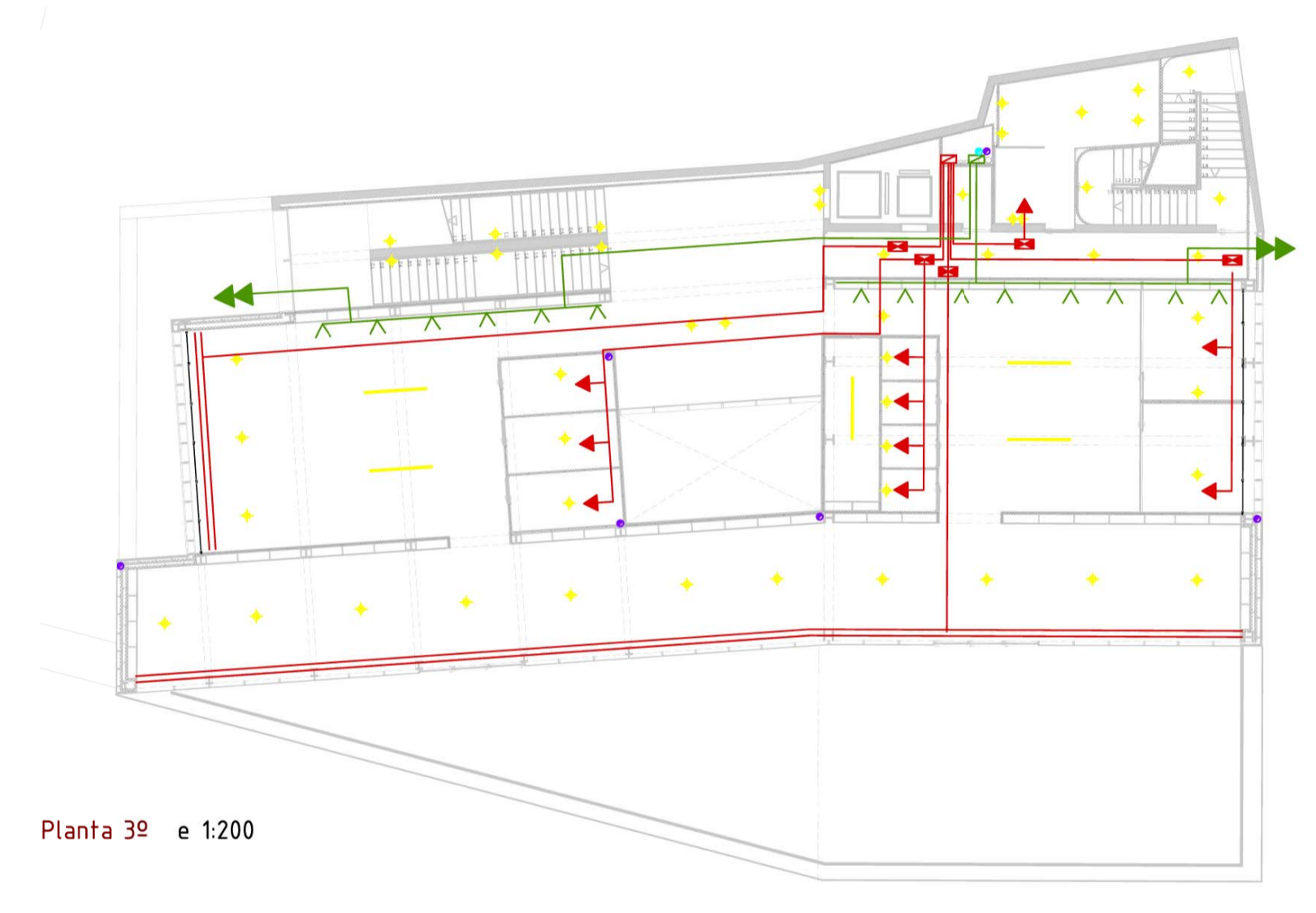

Planta 3º e 1:200

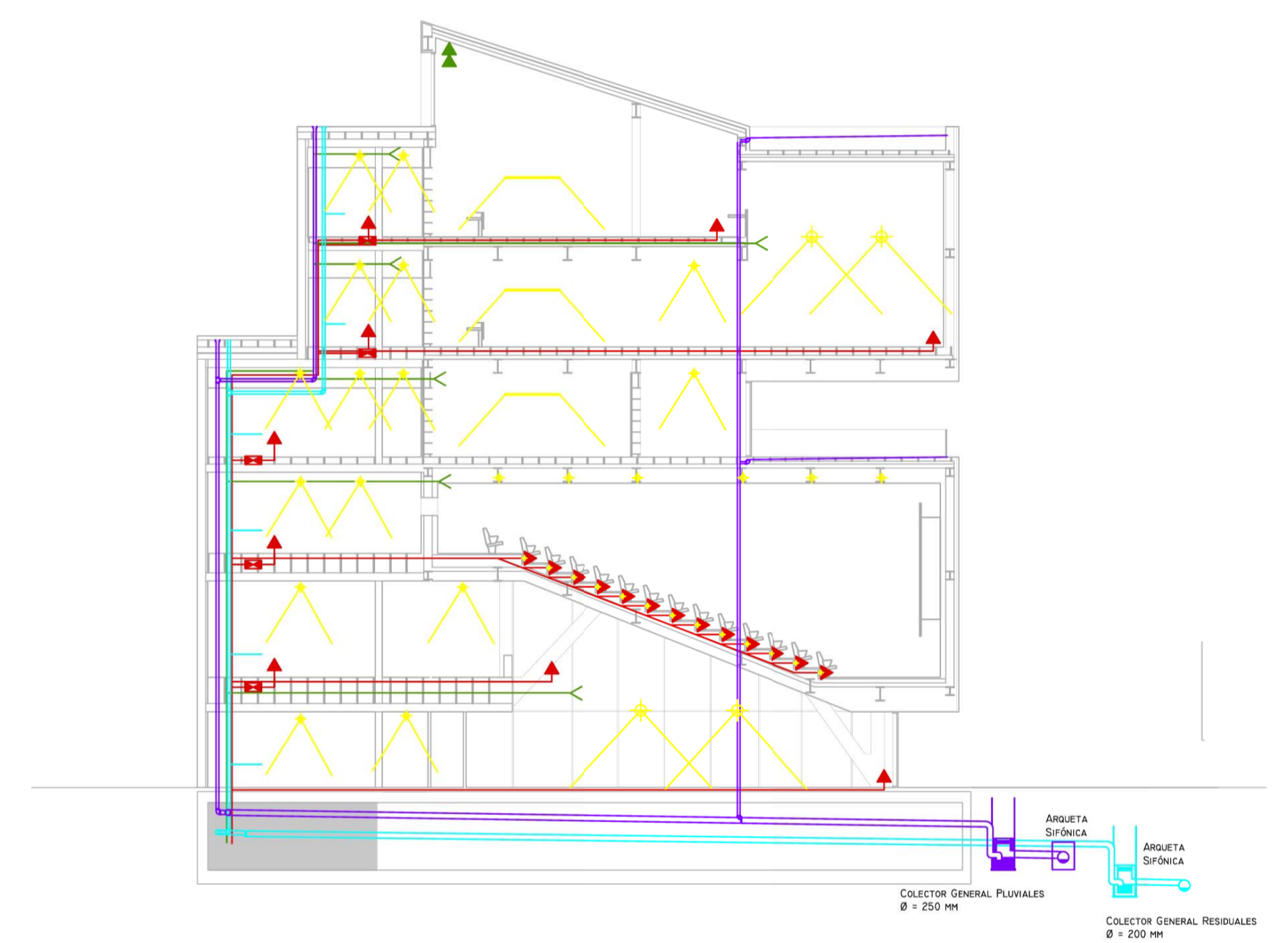

Planta 4º e 1:200

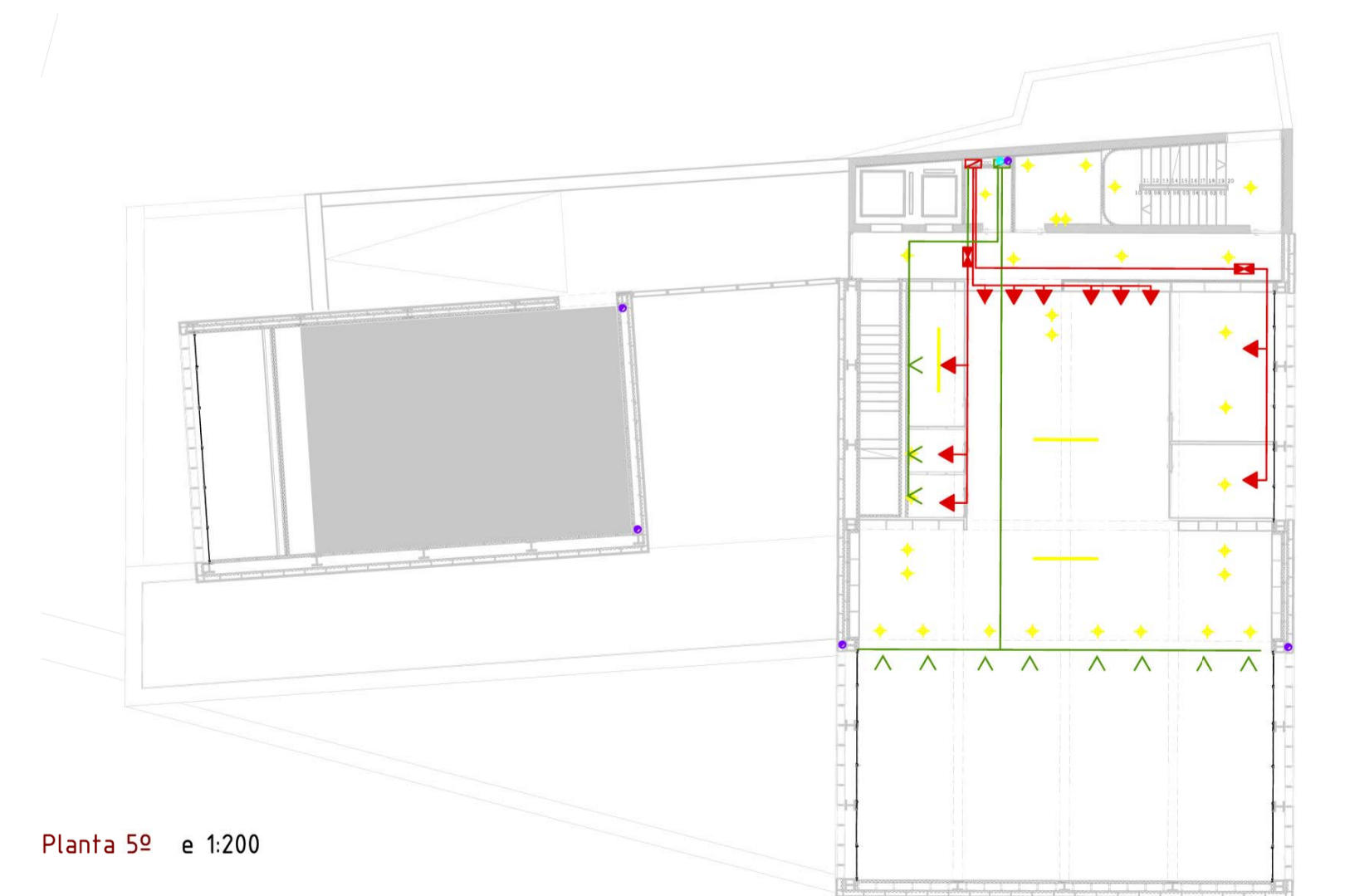

Planta 5º e 1:200

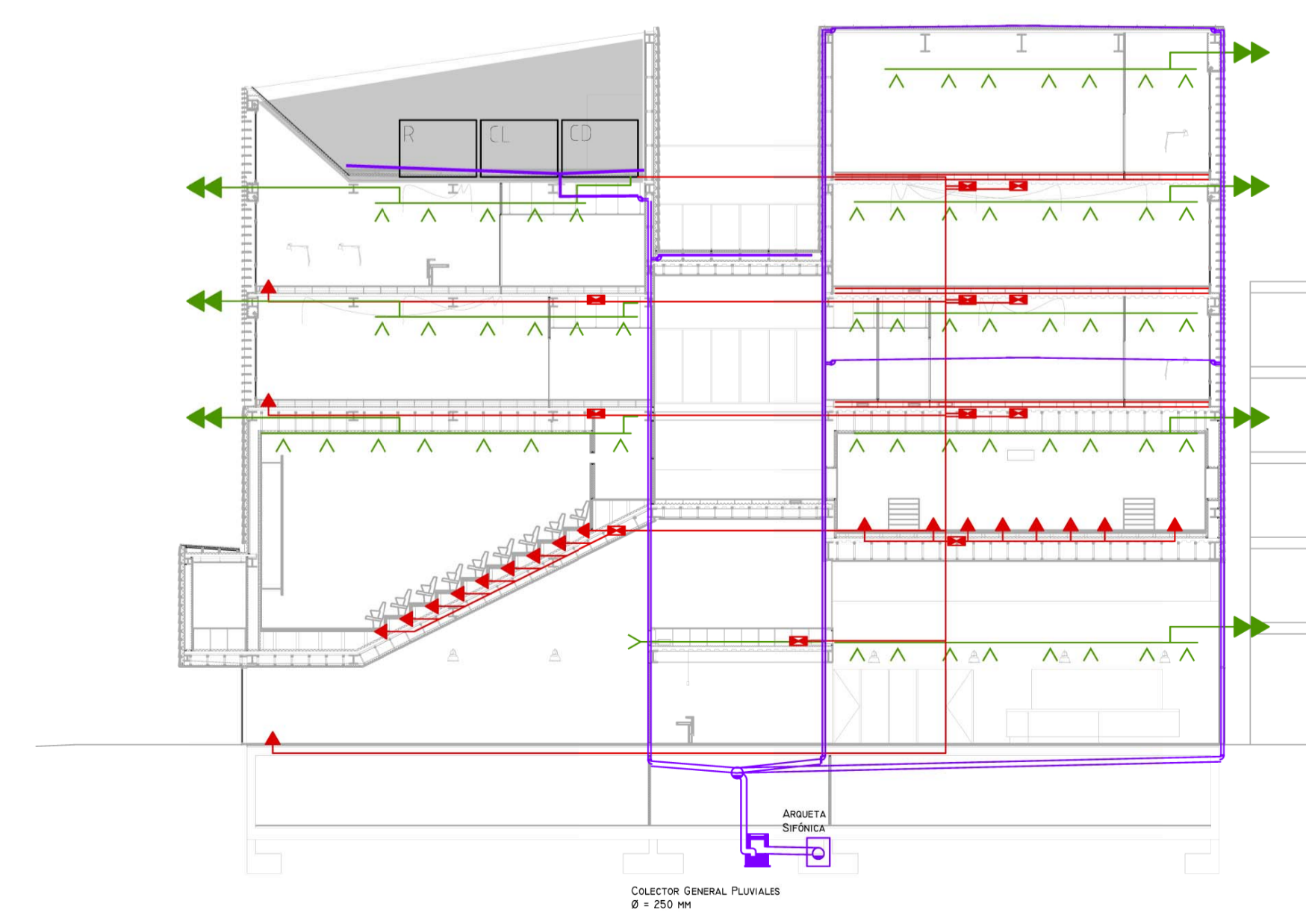

- Fan coil
- Impulsión aire lineal
- ▲ Impulsión aire puntual
- ◀ Retorno aire puntual
- ▶ Expulsión de aire
- Bajante aguas pluviales
- Bajante aguas negras
- ◆ Punto de luz

