

ALÇAT LATERAL

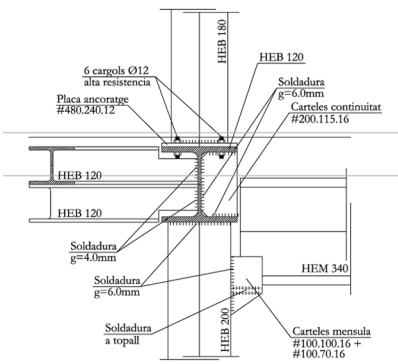

ALÇAT OFICINES

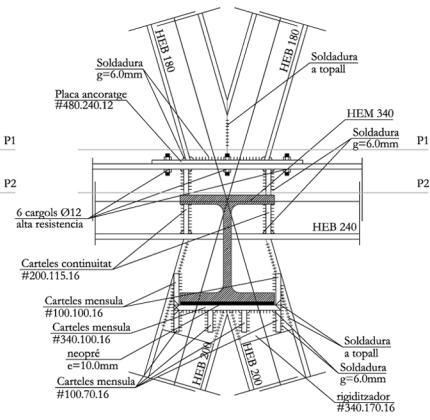

ALÇAT PASSADIS

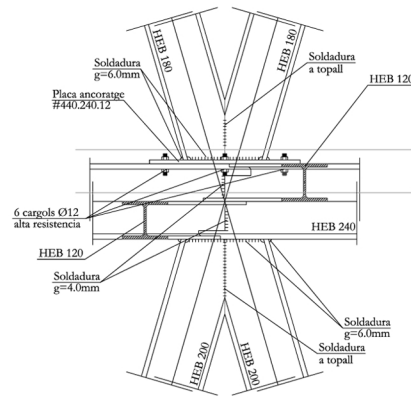

PLANTA 1

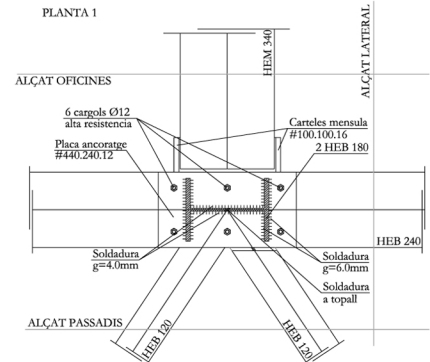

PLANTA 2

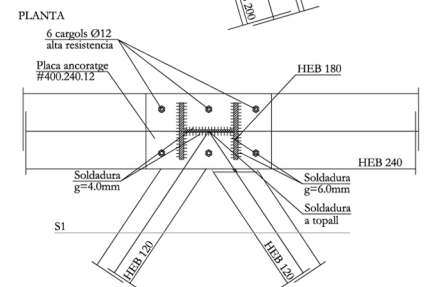
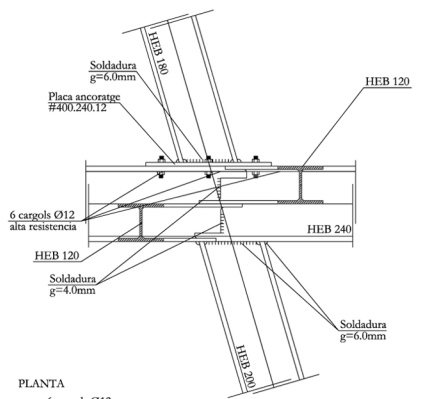
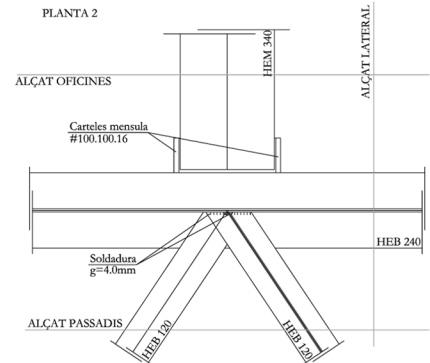

D1

D3

ALÇAT INTERIOR

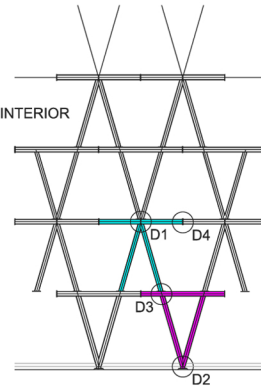

ALÇAT EXTERIOR

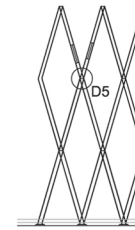

ESTRATÈGIES SUPORT

Mòdul Estructural E 1/20

Detall dels nous D1,D3,D4,D5 1/10

Detall del ms D2 1/20

S

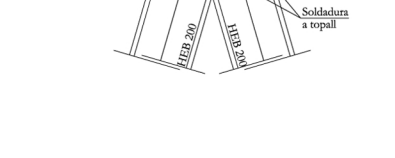
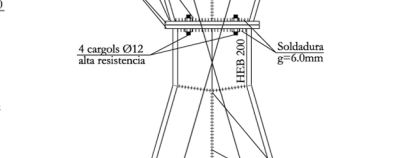
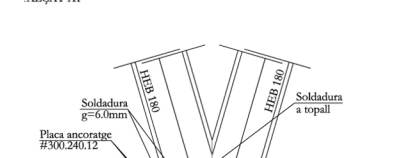
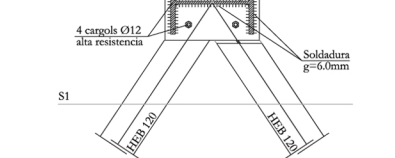
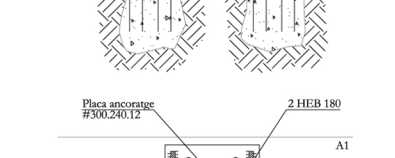
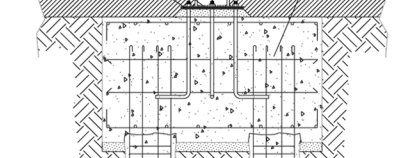
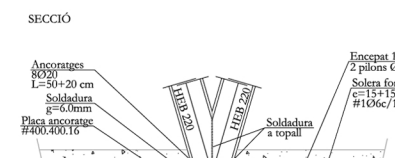
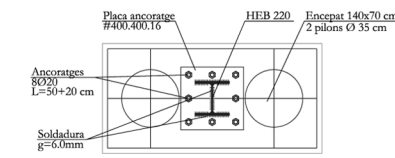
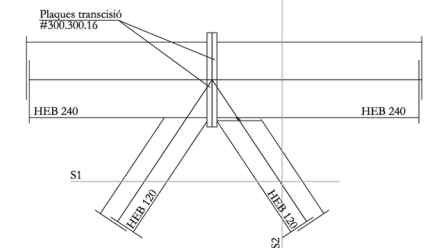
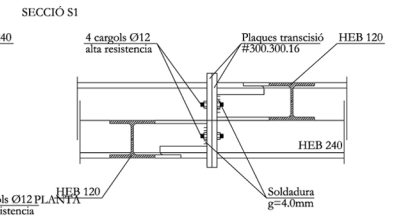
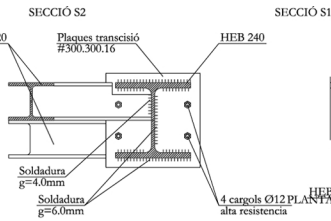

D4

D2

D5

