

Títol del projecte:  
 Projecte de variant entre la Me-1 i la Me15 al terme municipal de Mercadal (Menorca)

Autor:  
 Pons Florit, Neus

Tutor:  
 Fernandez de Villalta Ferrer-Dalmau, Eduardo

Títol del plànol:  
 Perfils transversals Eix 1 pk 0+040 a 0+460

Escala A3:  
 1:400

Plànol núm:  
 7A 1 de 7  
 Data:  
 Setembre 2015

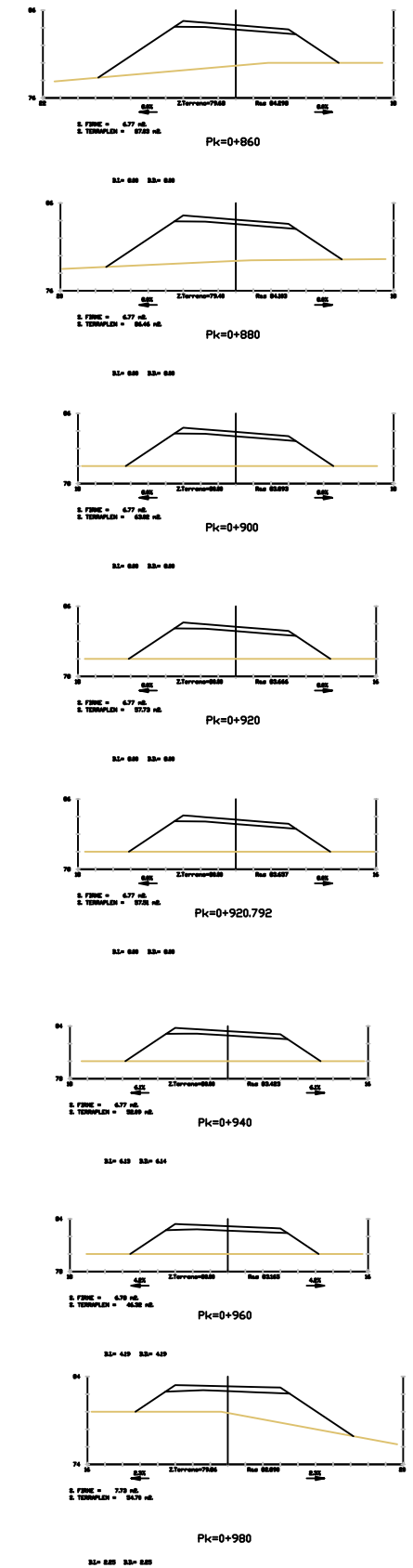
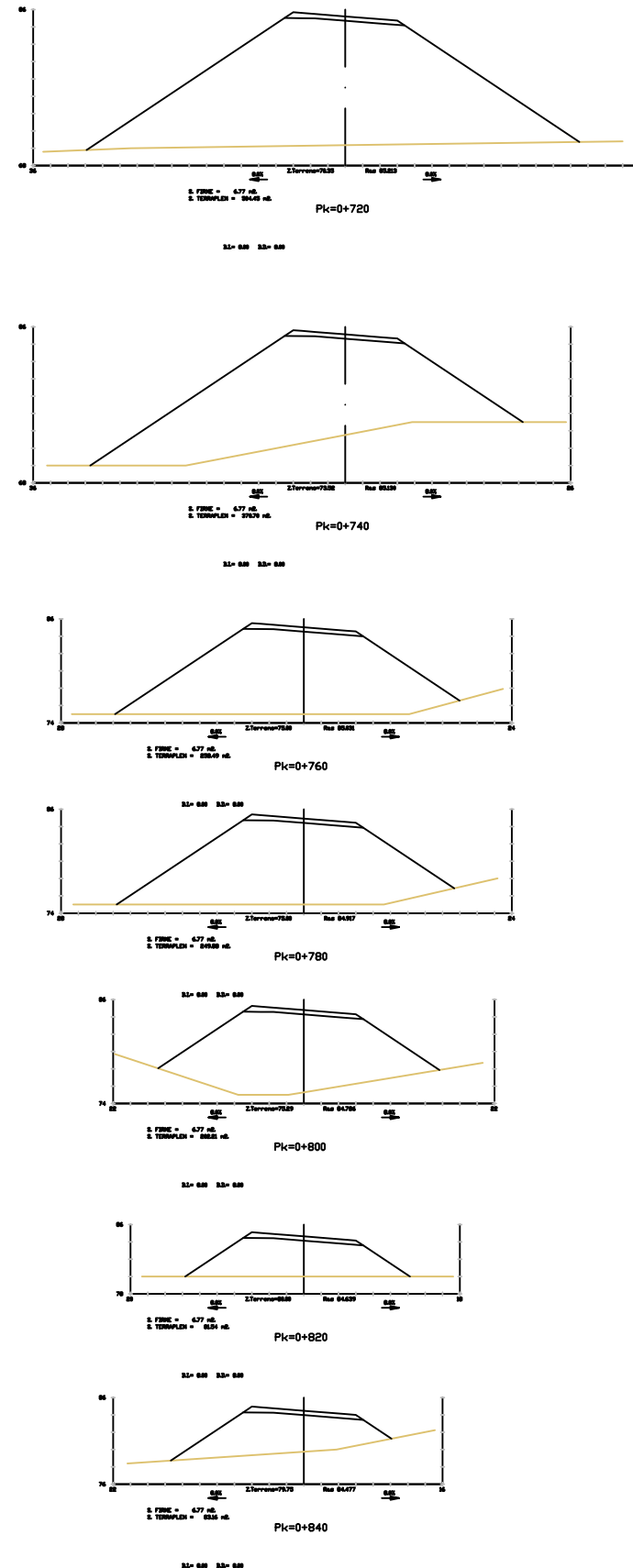
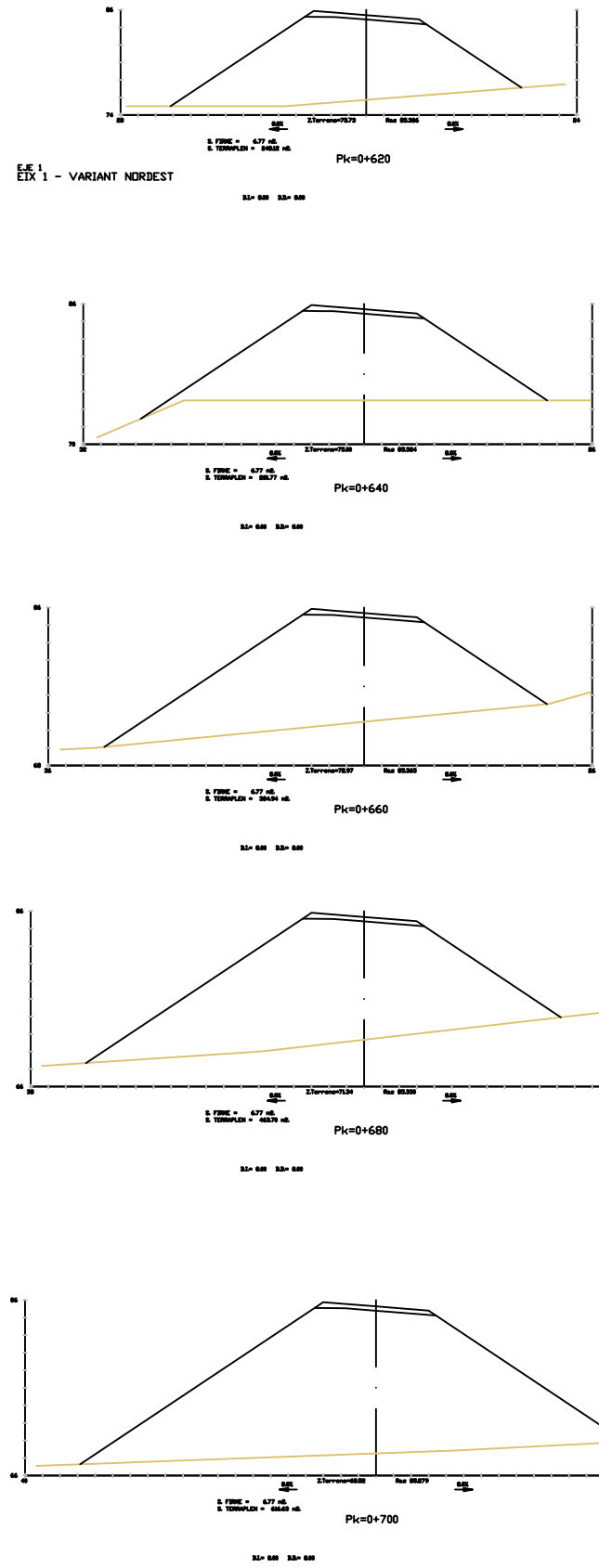
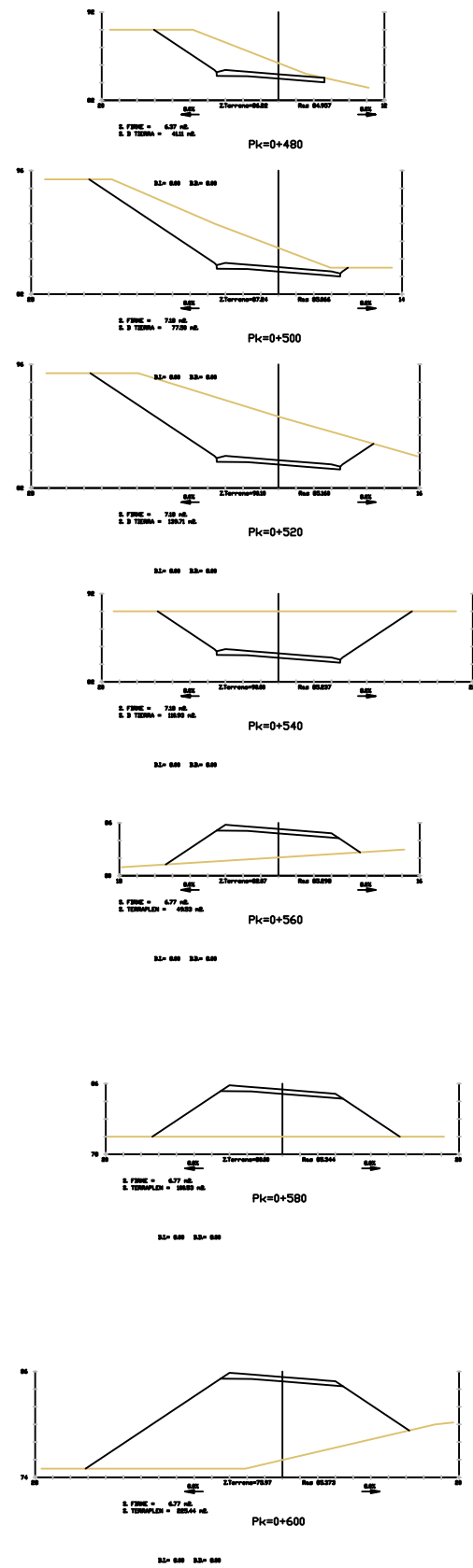

Títol del projecte:  
 Projecte de variant entre la Me-1 i la Me15 al terme municipal de Mercadal (Menorca)

Autor:  
 Pons Florit, Neus

Tutor:  
 Fernandez de Villalta Ferrer-Dalmau, Eduardo

Títol del plànol:  
 Perfils transversals Eix 1 pk 0+480 a 0+980

Escala A3:  
 1:400

Plànol núm:  
 7A 2 de 7  
 Data:  
 Setembre 2015

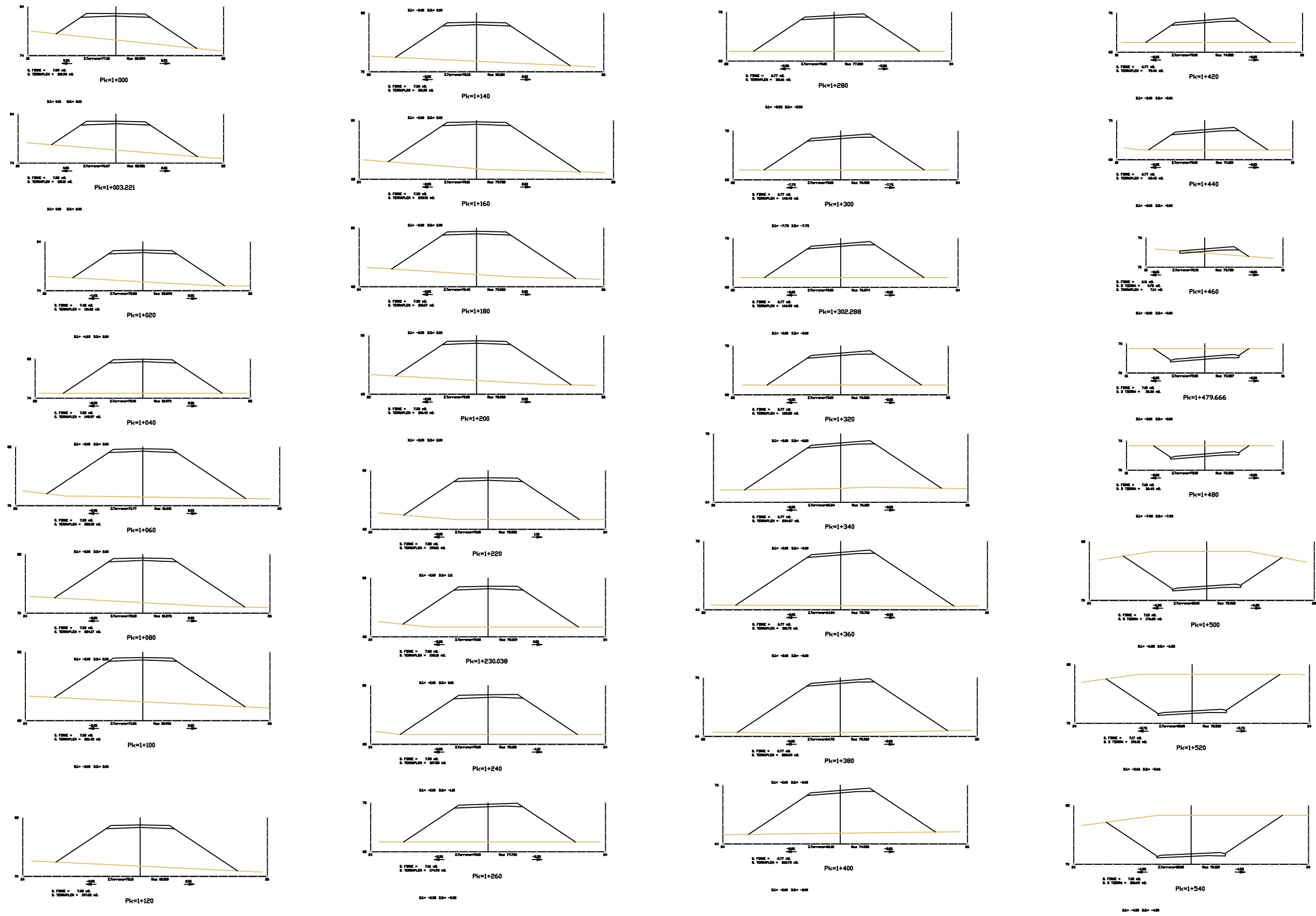

Títol del projecte:  
 Projecte de variant entre la Me-1 i la Me15 al terme municipal de Mercadal (Menorca)

Autor:  
 Pons Florit, Neus

Tutor:  
 Fernandez de Villalta Ferrer-Dalmau, Eduardo

Títol del plànol:  
 Perfils transversals Eix 1 pk 1+000 a 1+540

Escala A3:  
 1:400

Plànol núm:  
 7A 3 de 7  
 Data:  
 Setembre 2015

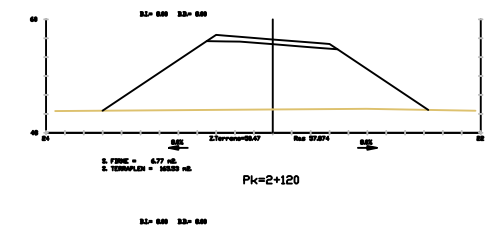
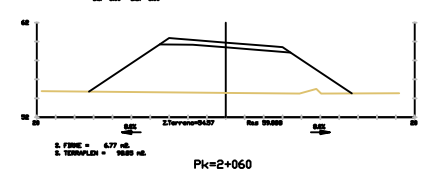
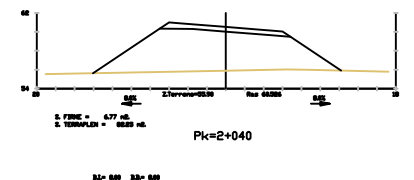
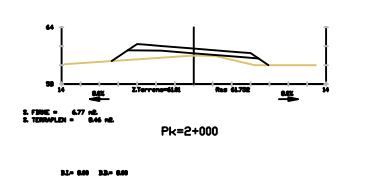
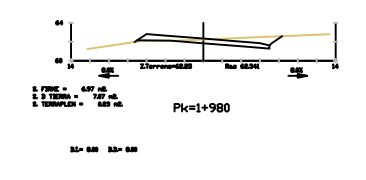
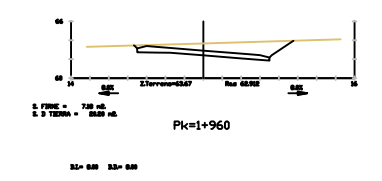
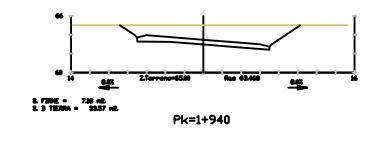
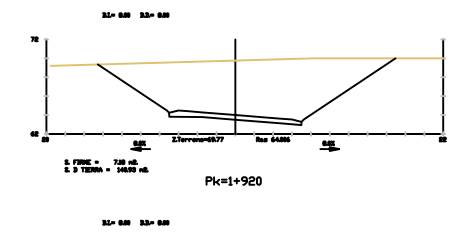
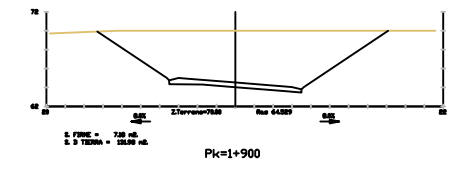
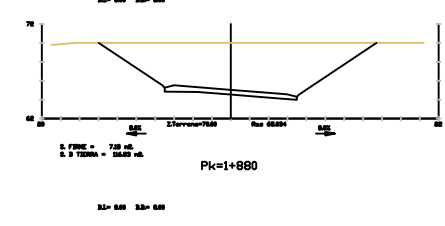
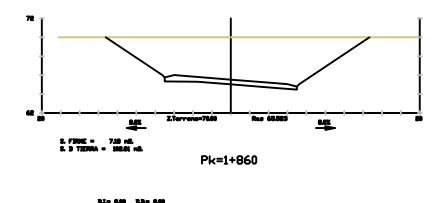
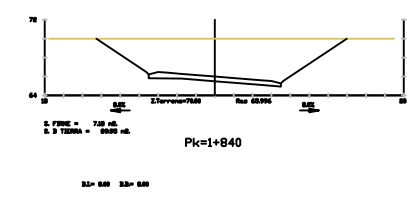
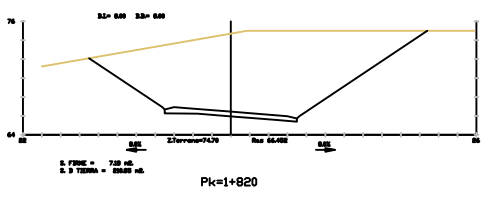
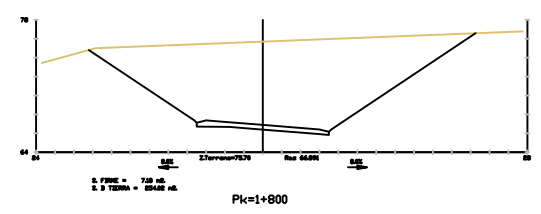
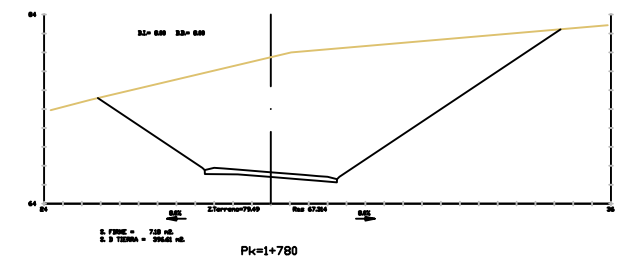
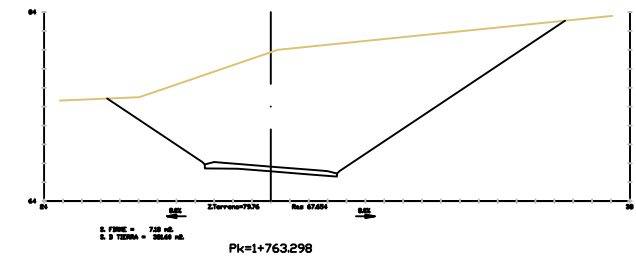
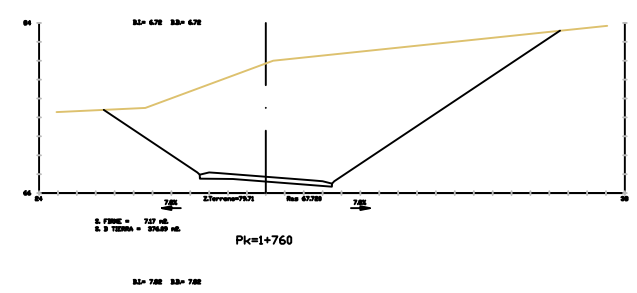
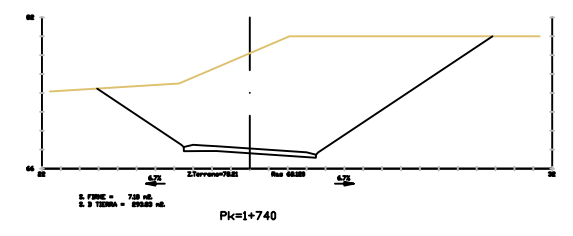
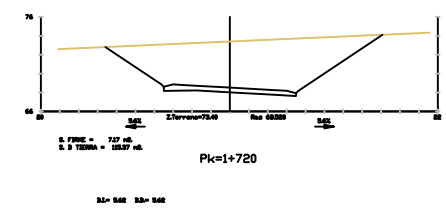
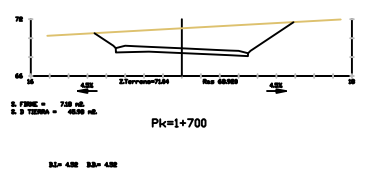
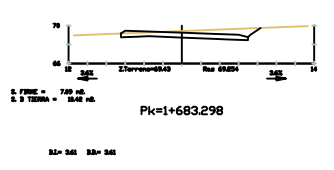
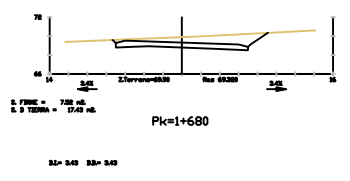
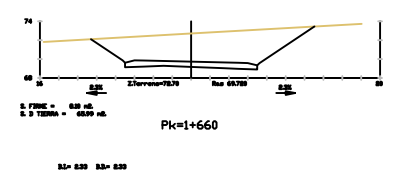
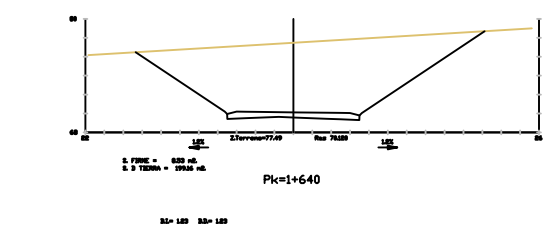
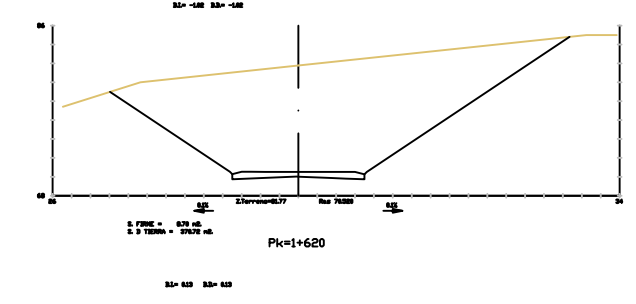
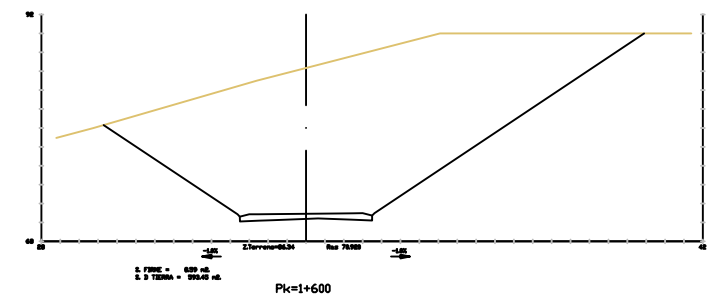
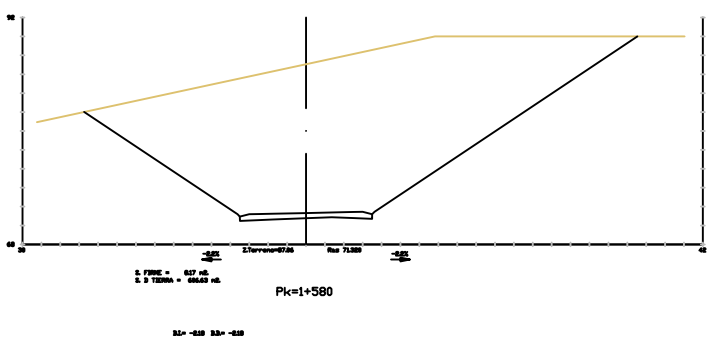
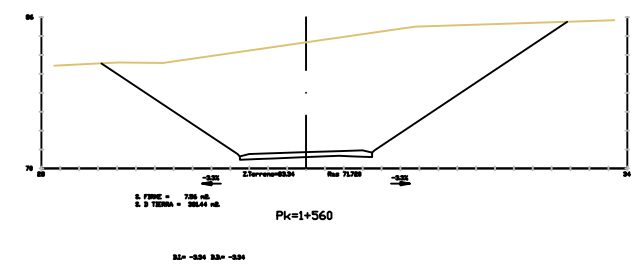
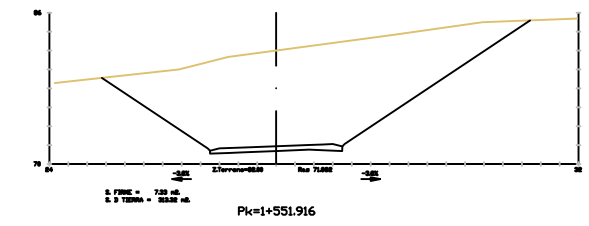

Títol del projecte: Projecte de variant entre la Me-1 i la Me15 al terme municipal de Mercadal (Menorca)	Autor: Pons Florit, Neus	Tutor: Fernandez de Villalta Ferrer-Dalmau, Eduardo	Títol del plànol: Perfils transversals Eix 1 pk 1+551,96 a 2+120	Escala A3: 1:400	Plànol núm: 7A 4 de 7 Data: Setembre 2015
---	-----------------------------	--	---	---------------------	--

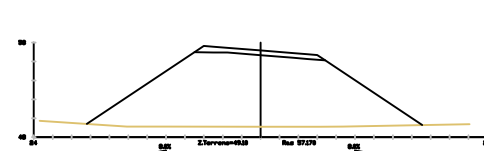

Pk=2+140  
 S. FINEC = 477 m.  
 S. TORNAPLÉN = 3820 m.

S1= 600 S2= 600

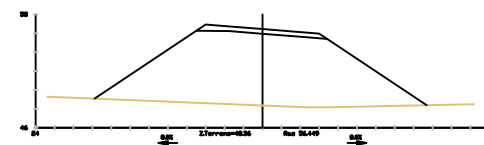

Pk=2+160  
 S. FINEC = 477 m.  
 S. TORNAPLÉN = 3820 m.

S1= 600 S2= 600

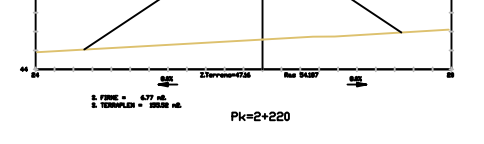

Pk=2+220  
 S. FINEC = 477 m.  
 S. TORNAPLÉN = 3820 m.

S1= 600 S2= 600

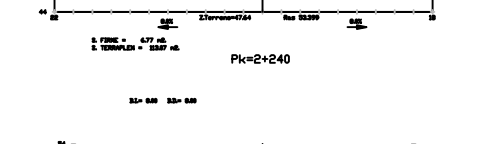

Pk=2+240  
 S. FINEC = 477 m.  
 S. TORNAPLÉN = 3820 m.

S1= 600 S2= 600

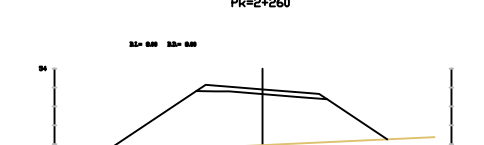

Pk=2+260  
 S. FINEC = 477 m.  
 S. TORNAPLÉN = 3720 m.

S1= 600 S2= 600



Pk=2+280  
 S. FINEC = 477 m.  
 S. TORNAPLÉN = 3820 m.

S1= 600 S2= 600

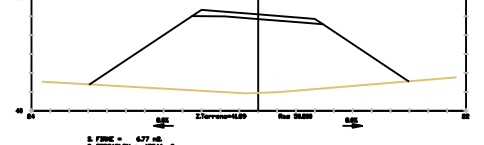

Pk=2+300  
 S. FINEC = 477 m.  
 S. TORNAPLÉN = 3720 m.

S1= 600 S2= 600

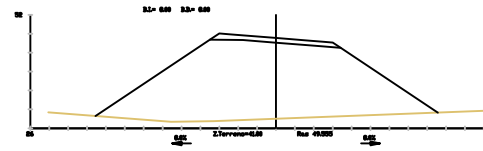

Pk=2+336.131  
 S. FINEC = 477 m.  
 S. TORNAPLÉN = 3820 m.

S1= 600 S2= 600

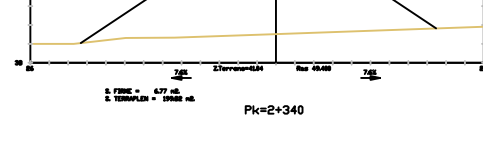

Pk=2+340  
 S. FINEC = 477 m.  
 S. TORNAPLÉN = 3720 m.

S1= 740 S2= 740

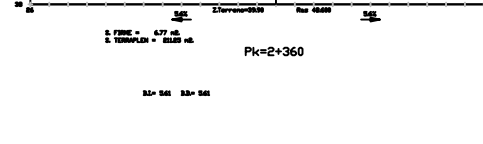

Pk=2+360  
 S. FINEC = 477 m.  
 S. TORNAPLÉN = 3820 m.

S1= 600 S2= 600

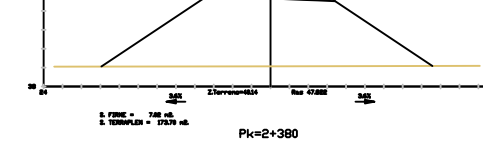

Pk=2+380  
 S. FINEC = 740 m.  
 S. TORNAPLÉN = 3720 m.

S1= 600 S2= 600

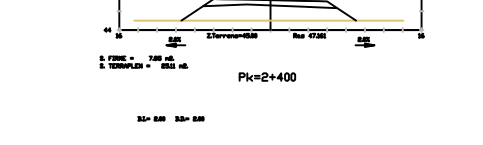

Pk=2+400  
 S. FINEC = 740 m.  
 S. TORNAPLÉN = 3820 m.

S1= 600 S2= 600



Pk=2+420  
 S. FINEC = 740 m.  
 S. TORNAPLÉN = 3820 m.

S1= 600 S2= 600

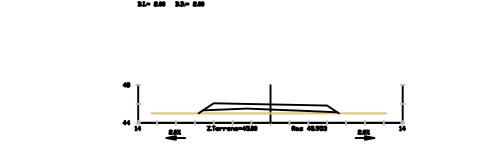

Pk=2+440  
 S. FINEC = 740 m.  
 S. TORNAPLÉN = 3820 m.

S1= 600 S2= 600



Pk=2+460  
 S. FINEC = 740 m.  
 S. TORNAPLÉN = 3820 m.

S1= 600 S2= 600



Pk=2+480  
 S. FINEC = 740 m.  
 S. TORNAPLÉN = 3820 m.



Pk=2+500  
 S. FINEC = 740 m.  
 S. TORNAPLÉN = 3820 m.



Pk=2+520  
 S. FINEC = 740 m.  
 S. TORNAPLÉN = 3820 m.



Pk=2+540  
 S. FINEC = 740 m.  
 S. TORNAPLÉN = 3820 m.

S1= 600 S2= 600

Títol del projecte:  
 Projecte de variant entre la Me-1 i la Me15 al terme municipal de Mercadal (Menorca)

Autor:  
 Pons Florit, Neus

Tutor:  
 Fernandez de Villalta Ferrer-Dalmau, Eduardo

Títol del plànol:  
 Perfils transversals Eix 1 pk 2+140 a 2+540

Escala A3:  
 1:400

Plànol núm:  
 7A 5 de 7  
 Data:  
 Setembre 2015

EX 3  
INTERSECCIÓ ME1 - RAMAL SORTIDA ME1-VARIANT

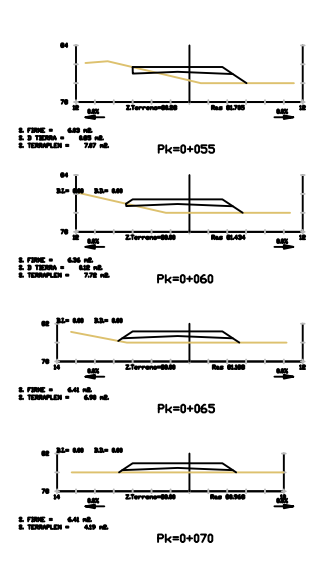

EX 4  
INTERSECCIÓ ME1 - RAMAL ENTRADA VARIANT-ME1

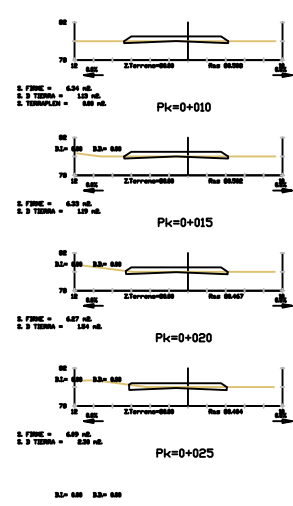

EX 5  
INTERSECCIÓ ME1 - ENLLAÇ

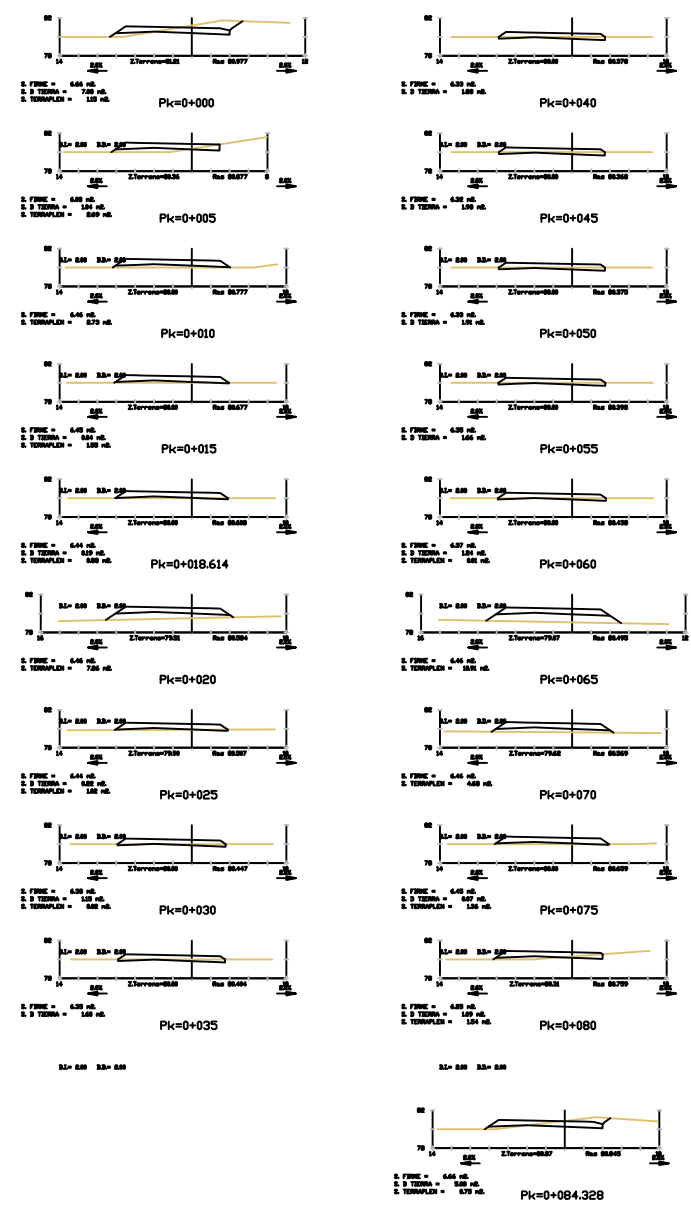

Pk=0+084.328

EX 6  
ROTONDA ME15

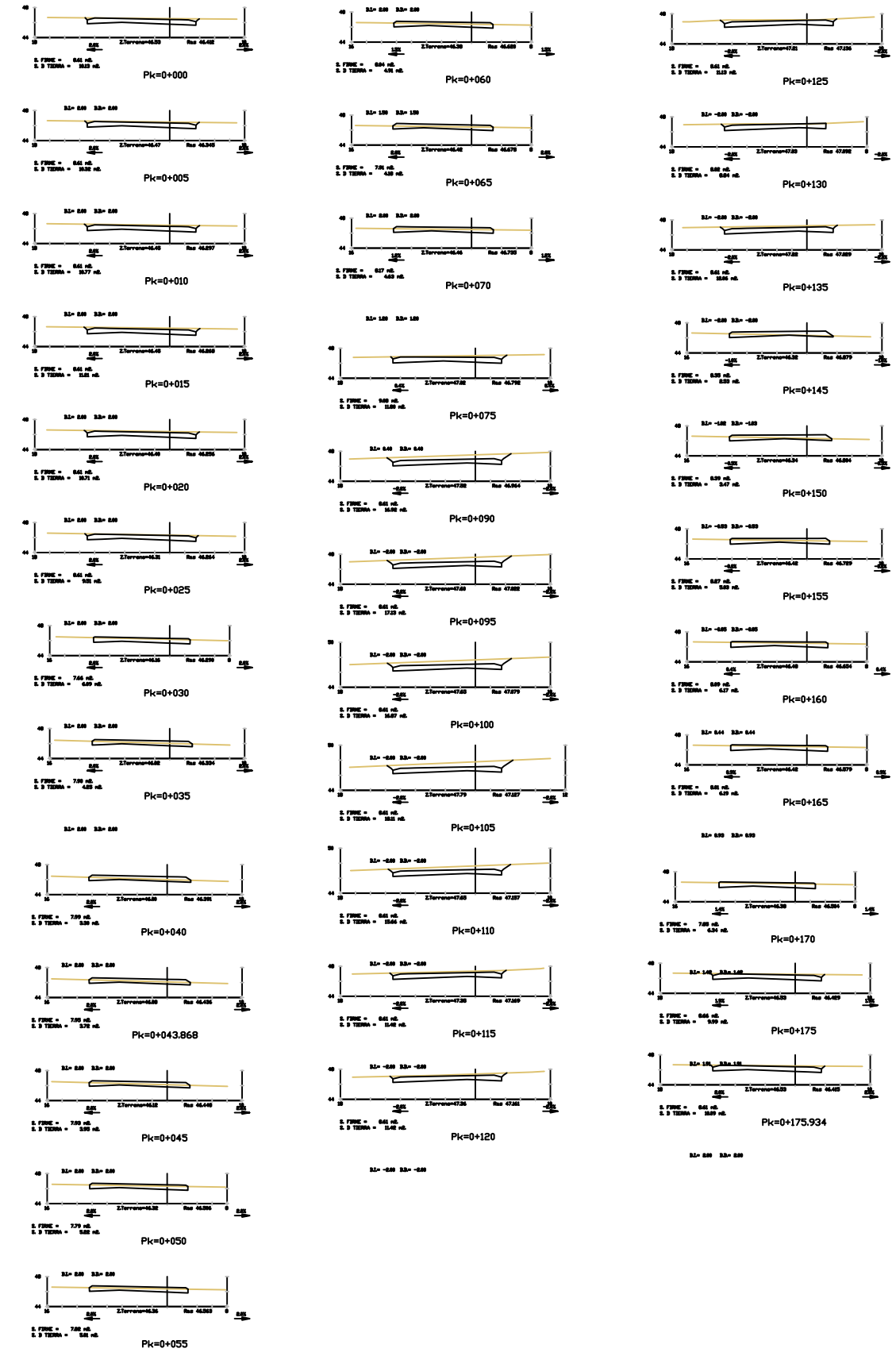

Títol del projecte:  
Projecte de variant entre la Me-1 i la Me15 al terme municipal de Mercadal (Menorca)

Autor:  
Pons Florit, Neus

Tutor:  
Fernandez de Villalta Ferrer-Dalmau, Eduardo

Títol del plànol:  
Perfils transversals Eix 3, 4, 5 i 6

Escala A3:  
1:400

Plànol núm:  
7A 6 de 7  
Data:  
Setembre 2015

E.E. 7  
ROTONDA ME15 - Me15 Nord

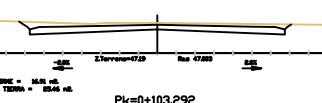
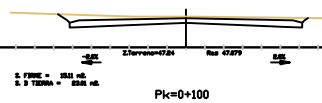
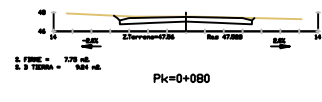
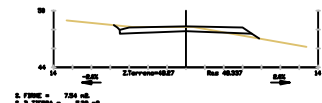
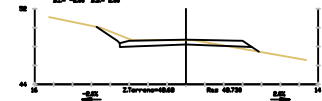
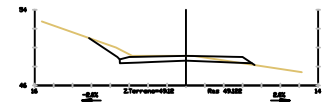

E.E. 8  
ROTONDA ME15 - Me15 Sud

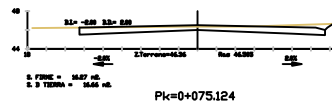
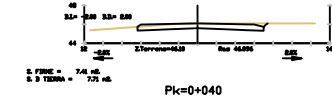
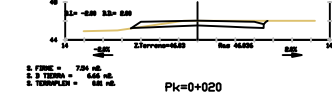
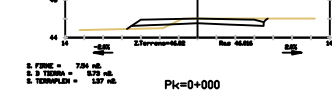

E.E. 9  
ROTONDA ME15 - accés conf

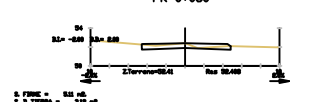
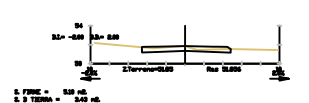
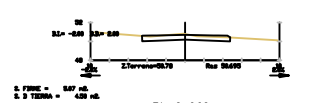
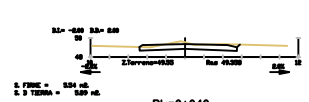
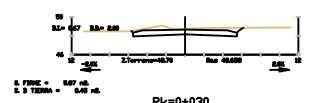
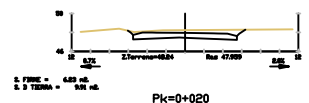

E.E. 10  
CAMI D'EN KANE

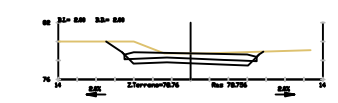
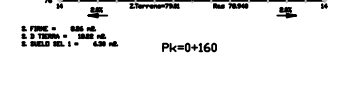
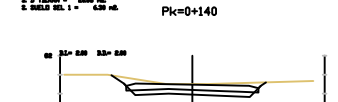
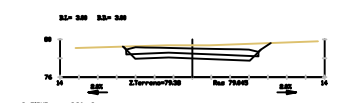
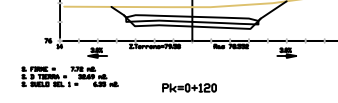
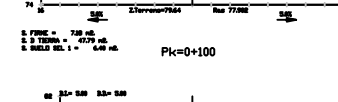
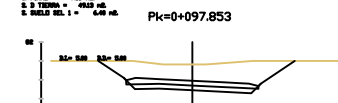
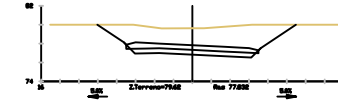
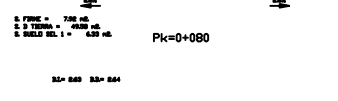
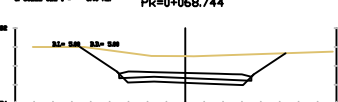
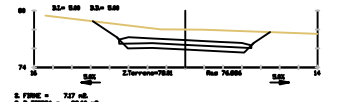
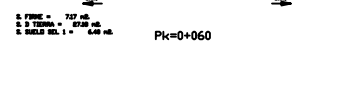
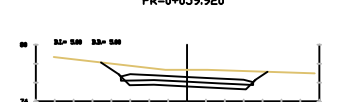
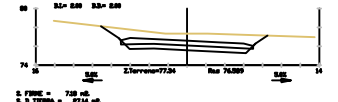
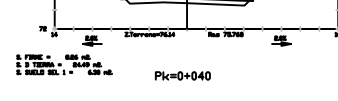
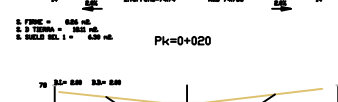
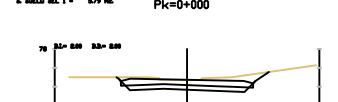
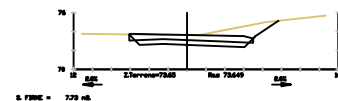

E.E. 11  
CAMI DE TRAMUNTANA

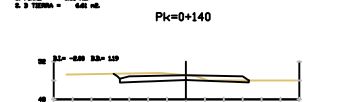
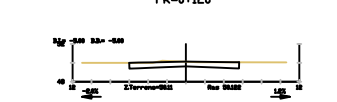
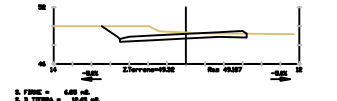
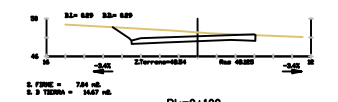
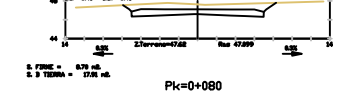
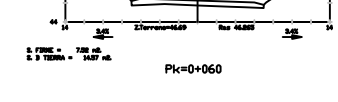
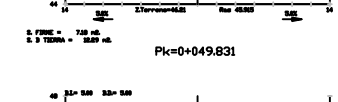
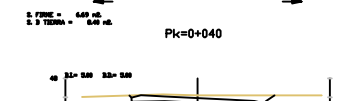
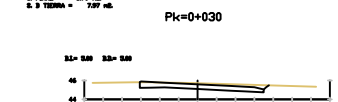
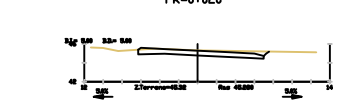
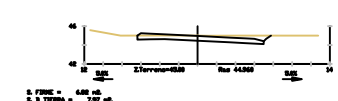

Títol del projecte:  
Projecte de variant entre la Me-1 i la Me15 al terme municipal de Mercadal (Menorca)

Autor:  
Pons Florit, Neus

Tutor:  
Fernandez de Villalta Ferrer-Dalmau, Eduardo

Títol del plànol:  
Perfils transversals Eix 7, 8, 9, 10 i 11

Escala A3:  
1:400

Plànol núm:  
7A 7 de 7  
Data:  
Setembre 2015

- 1 Capa de rodadura BBTM-11 A60/70 F 3 cm
- 2 Reg d'adherencia ECR-1d
- 3 Capa intermitja 7 cm AC22 BIN 60/70 S
- 4 Reg d'adherencia ECR-1d
- 5 Capa base 15 cm AC22 BIN 60/70 G
- 6 Reg d'imprimació ECL
- 7 Base tot-ú artificial 25 cm
- 8 Conducció electrica

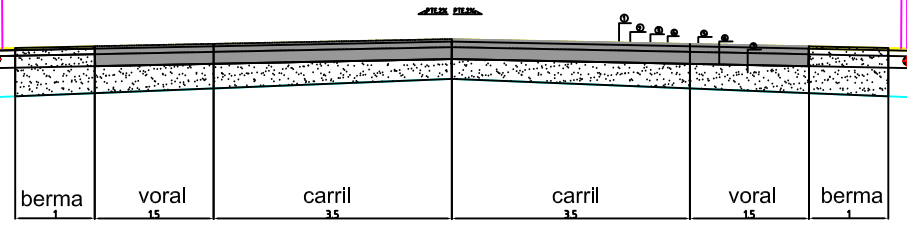

## EIX 1

- 1 Capa de rodadura BBTM-11 A60/70 F 3 cm
- 2 Reg d'adherencia ECR-1d
- 3 Capa intermitja 7 cm AC22 BIN 60/70 S
- 4 Reg d'adherencia ECR-1d
- 5 Capa base 15 cm AC22 BIN 60/70 G
- 6 Reg d'imprimació ECL
- 7 Base tot-ú artificial 25 cm
- 8 Conducció elèctrica
- 9 Rigola
- 10 Bordillo pref. formigó
- 11 Base de formigó

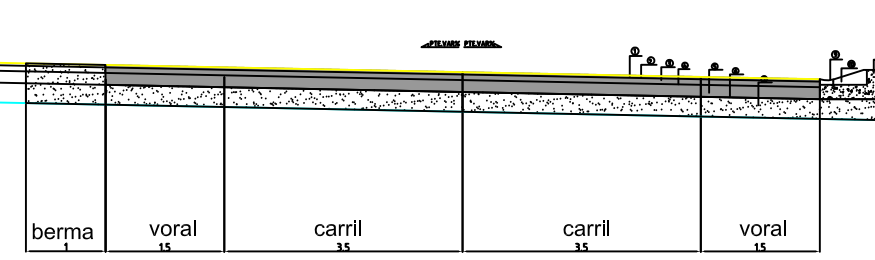

## EIX 6

Títol del projecte: Projecte de variant entre la Me-1 i la Me-15 al terme municipal de Mercadal (Menorca)	Autor: Pons Florit, Neus	Tutor: Fernandez De Villalta Ferrer-Dalmau, Eduardo	Títol del plànol: SECCIÓ TIPUS	Escala: 1:200	Nº de plànol: 8A 1 de 1
					Data: Setembre 2015



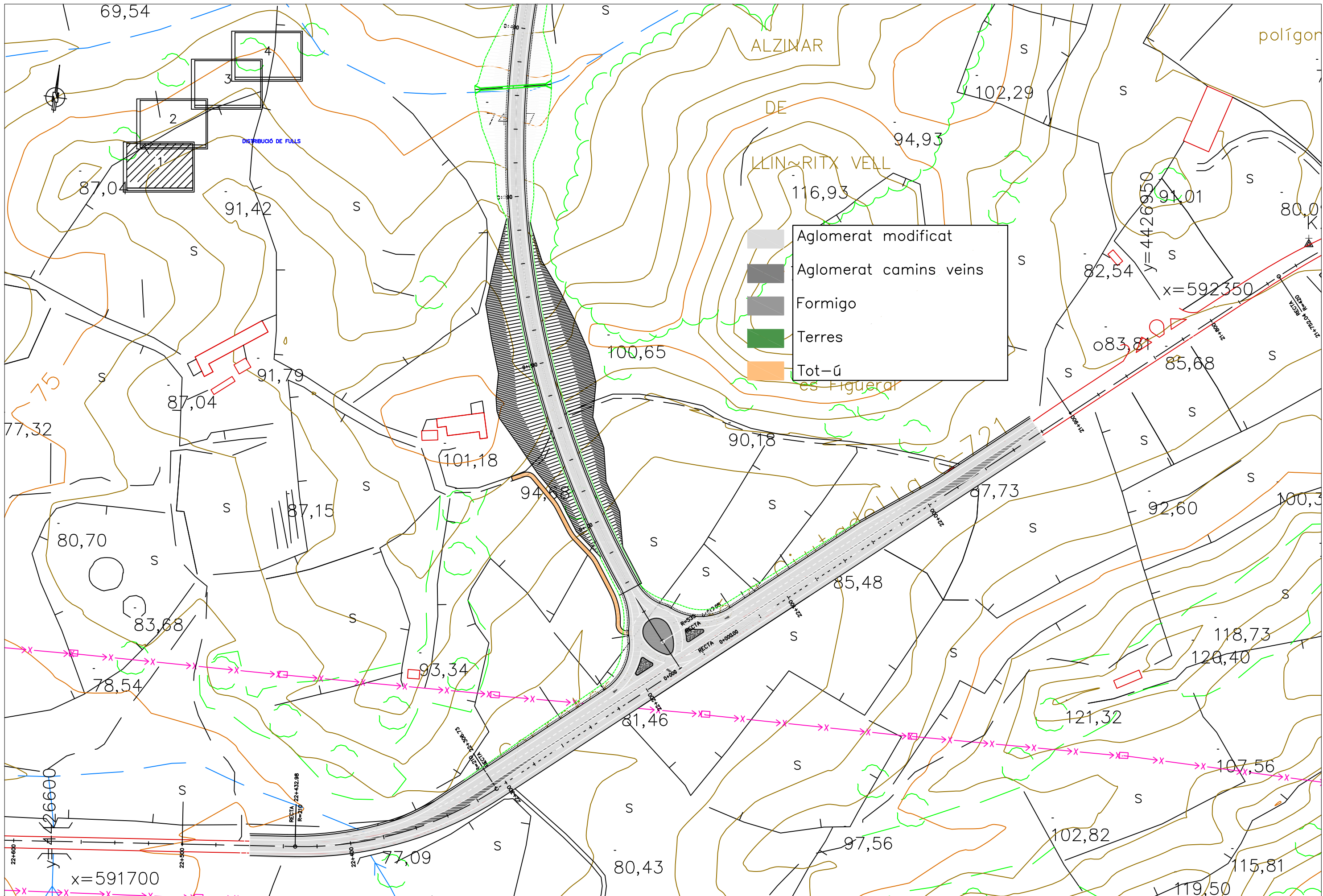

Títol del projecte: Projecte de variant entre la Me-1 i la Me15 al terme municipal de Mercadal (Menorca)	Autor: Pons Florit, Neus	Tutor: Fernandez de Villalta Ferrer-Dalmau, Eduardo	Títol del plànol: Pavimentació	Escala A3: 1:2000	Plànol núm: 9A 1 de 4 Data: Setembre 2015
---	-----------------------------	--	-----------------------------------	----------------------	--

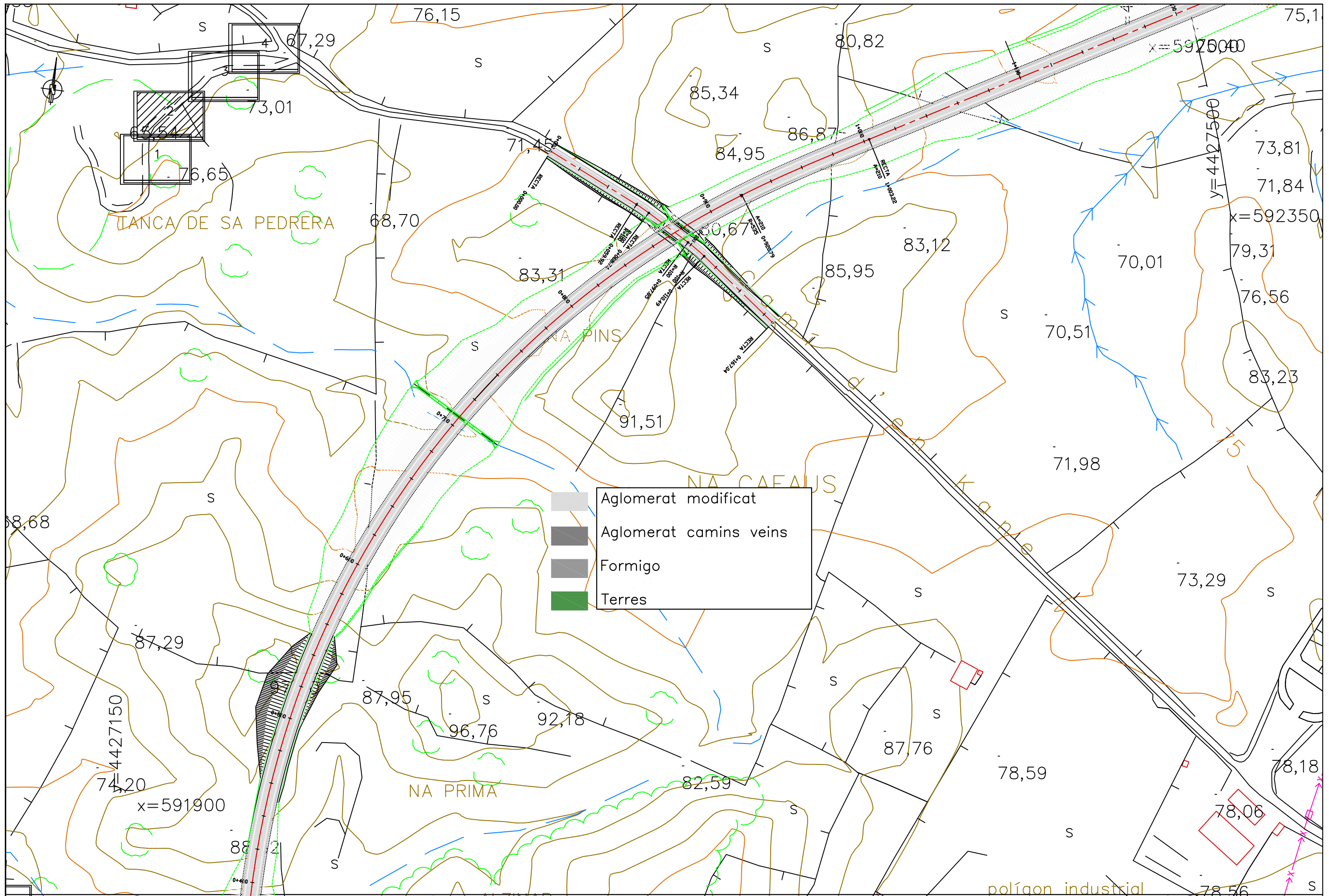

Títol del projecte: Projecte de variant entre la Me-1 i la Me15 al terme municipal de Mercadal (Menorca)	Autor: Pons Florit, Neus	Tutor: Fernandez de Villalta Ferrer-Dalmau, Eduardo	Títol del plànol: Pavimentació	Escala A3: 1:2000	Plànol núm: 9A 2 de 4 Data: Setembre 2015
---	-----------------------------	--	-----------------------------------	----------------------	--

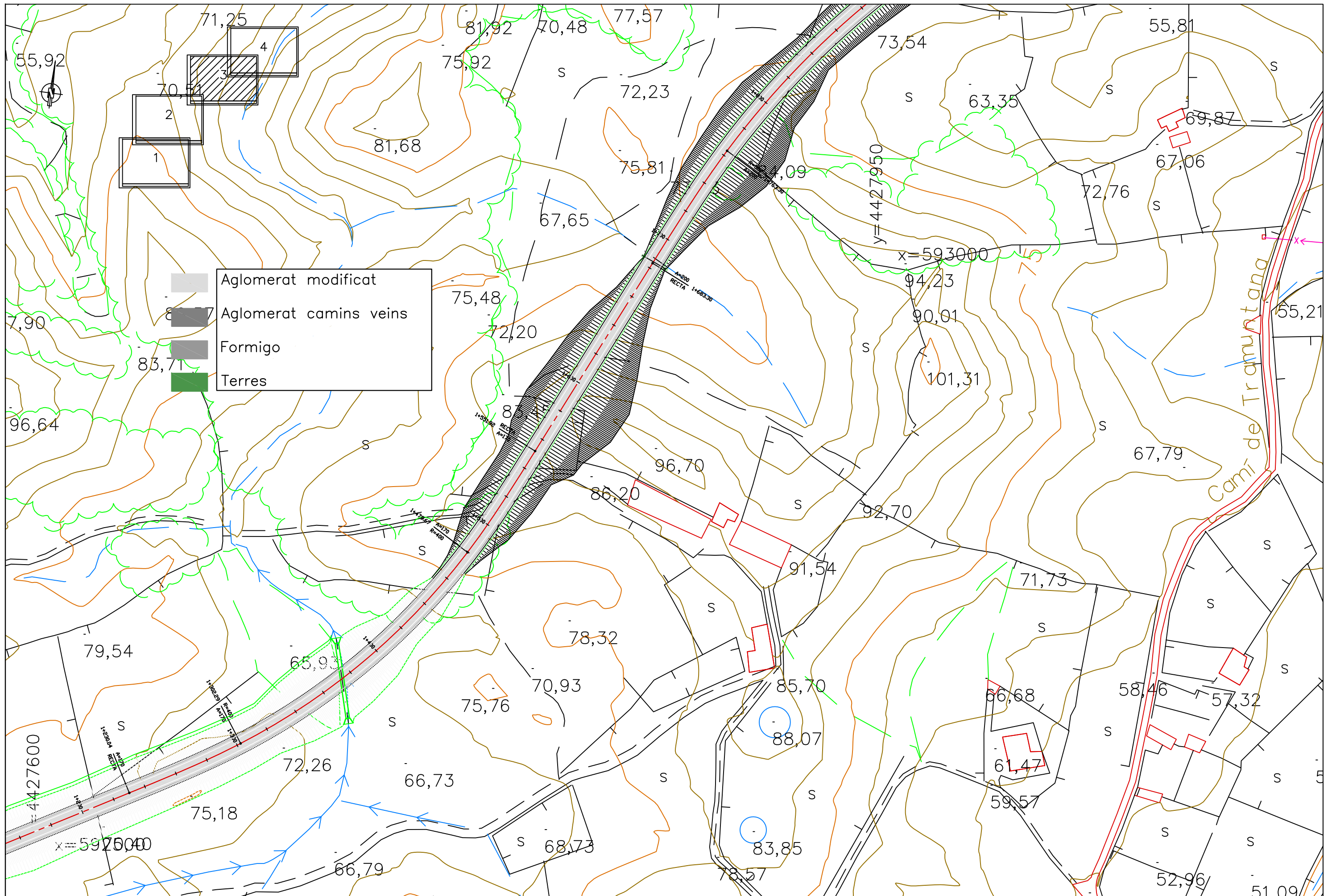

Títol del projecte: Projecte de variant entre la Me-1 i la Me15 al terme municipal de Mercadal (Menorca)	Autor: Pons Florit, Neus	Tutor: Fernandez de Villalta Ferrer-Dalmau, Eduardo	Títol del plànol: Pavimentació	Escala A3: 1:2000	Plànol núm: 9A 3 de 4 Data: Setembre 2015
---	-----------------------------	--	-----------------------------------	----------------------	--

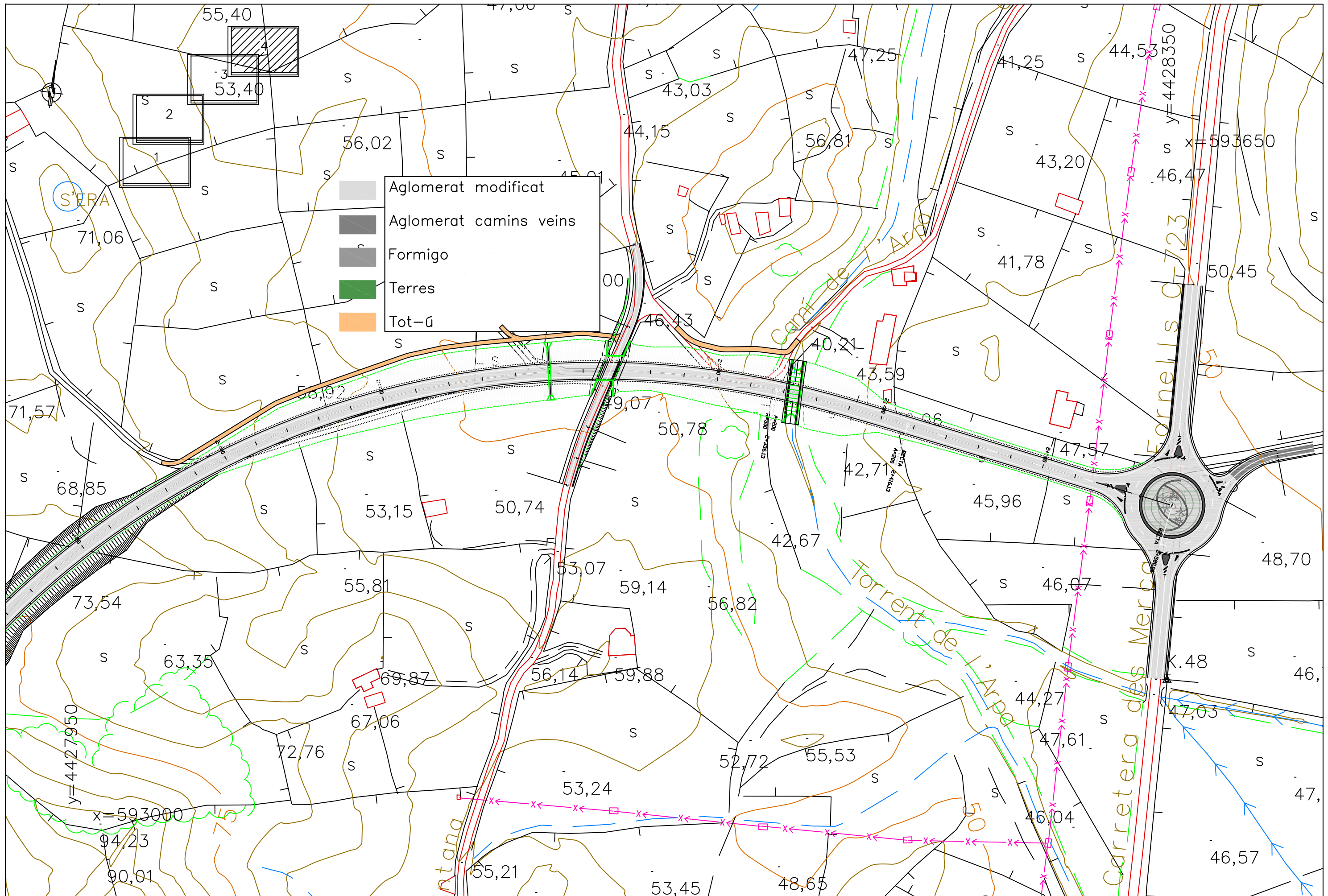

Títol del projecte: Projecte de variant entre la Me-1 i la Me15 al terme municipal de Mercadal (Menorca)	Autor: Pons Florit, Neus	Tutor: Fernandez de Villalta Ferrer-Dalmau, Eduardo	Títol del plànol: Pavimentació	Escala A3: 1:2000	Plànol núm: 9A 4 de 4 Data: Setembre 2015
---	-----------------------------	--	-----------------------------------	----------------------	--

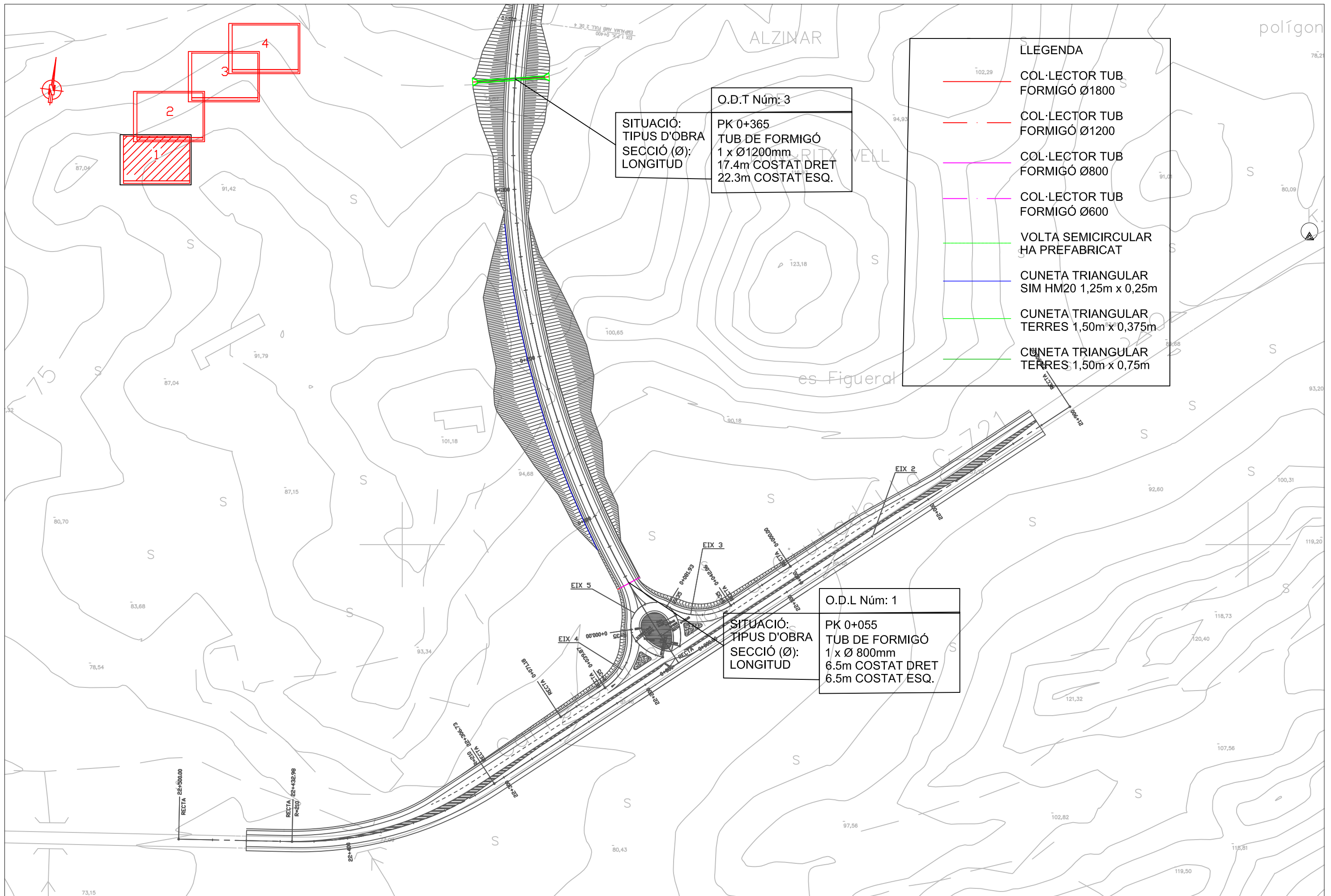

**LLEGENDA**

	COL·LECTOR TUB FORMIGÓ Ø1800
	COL·LECTOR TUB FORMIGÓ Ø1200
	COL·LECTOR TUB FORMIGÓ Ø800
	COL·LECTOR TUB FORMIGÓ Ø600
	VOLTA SEMICIRCULAR HA PREFABRICAT
	CUNETA TRIANGULAR SIM HM20 1,25m x 0,25m
	CUNETA TRIANGULAR TERRES 1,50m x 0,375m
	CUNETA TRIANGULAR TERRES 1,50m x 0,75m

O.D.T Núm: 3

SITUACIÓ:  
TIPUS D'OBRA  
SECCIÓ (Ø):  
LONGITUD

PK 0+365  
TUB DE FORMIGÓ  
1 x Ø1200mm  
17.4m COSTAT DRET  
22.3m COSTAT ESQ.

O.D.L Núm: 1

SITUACIÓ:  
TIPUS D'OBRA  
SECCIÓ (Ø):  
LONGITUD

PK 0+055  
TUB DE FORMIGÓ  
1 x Ø 800mm  
6.5m COSTAT DRET  
6.5m COSTAT ESQ.

Títol del projecte: Projecte de variant entre la Me-1 i la Me15 al terme municipal de Mercadal (Menorca)	Autor: Pons Florit, Neus	Tutor: Fernandez de Villalta Ferrer-Dalmau, Eduardo	Títol del plànol: Drenatge Plantes	Escala A3: 1:2000	Plànol núm: 10A 1 de 4
					Data: Setembre 2015

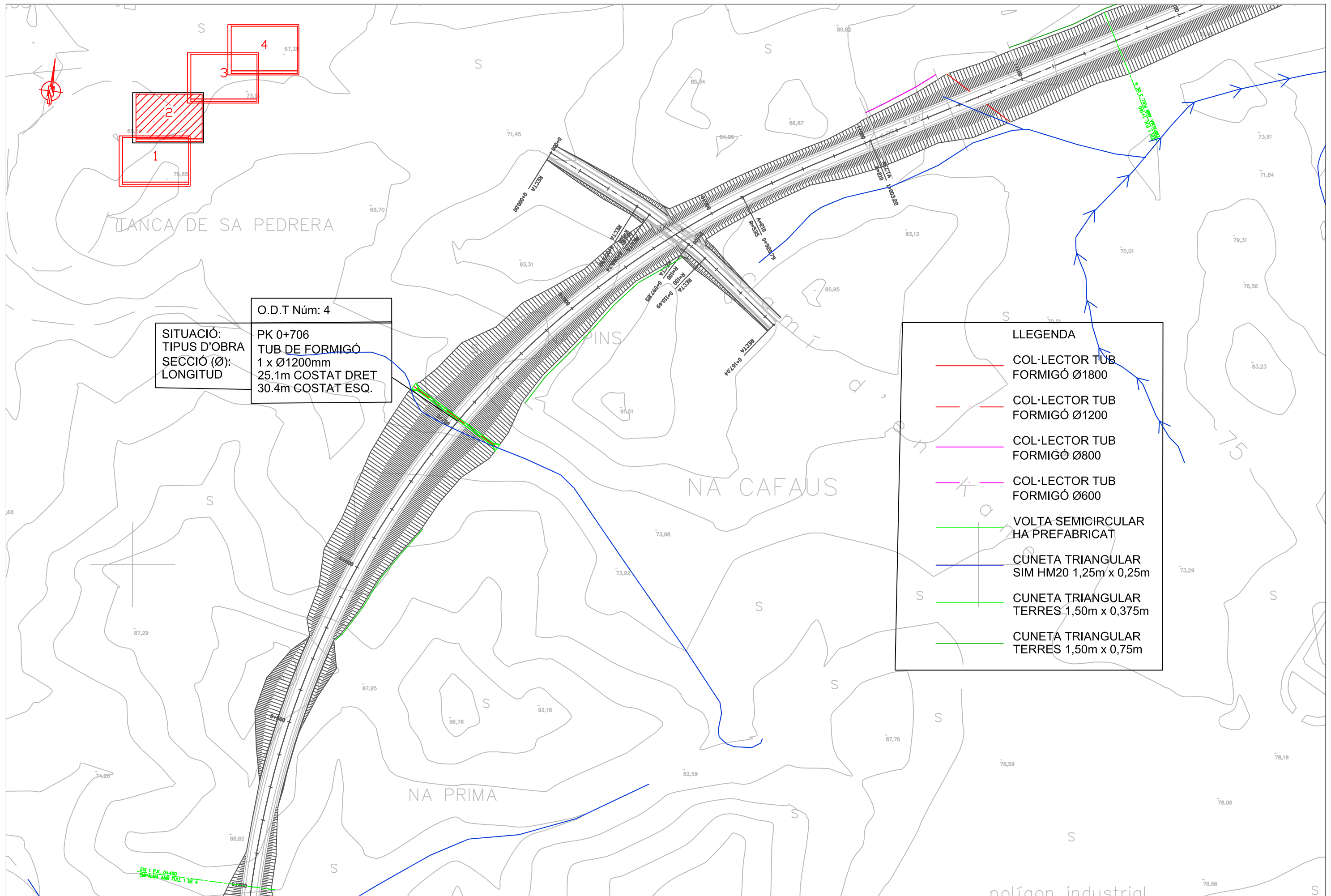

O.D.T Núm: 4

SITUACIÓ: PK 0+706  
 TIPUS D'OBRA: TUB DE FORMIGÓ  
 SECCIÓ (Ø): 1 x Ø1200mm  
 LONGITUD: 25.1m COSTAT DRET  
 30.4m COSTAT ESQ.

- LLEGENDA**
- COL·LECTOR TUB FORMIGÓ Ø1800
  - COL·LECTOR TUB FORMIGÓ Ø1200
  - COL·LECTOR TUB FORMIGÓ Ø800
  - COL·LECTOR TUB FORMIGÓ Ø600
  - VOLTA SEMICIRCULAR HA PREFABRICAT
  - CUNETA TRIANGULAR SIM HM20 1,25m x 0,25m
  - CUNETA TRIANGULAR TERRES 1,50m x 0,375m
  - CUNETA TRIANGULAR TERRES 1,50m x 0,75m

Títol del projecte: Projecte de variant entre la Me-1 i la Me15 al terme municipal de Mercadal (Menorca)	Autor: Pons Florit, Neus	Tutor: Fernandez de Villalta Ferrer-Dalmau, Eduardo	Títol del plànol: Drenatge Plantes	Escala A3: 1:2000	Plànol núm: 10A 2 de 4
					Data: Setembre 2015

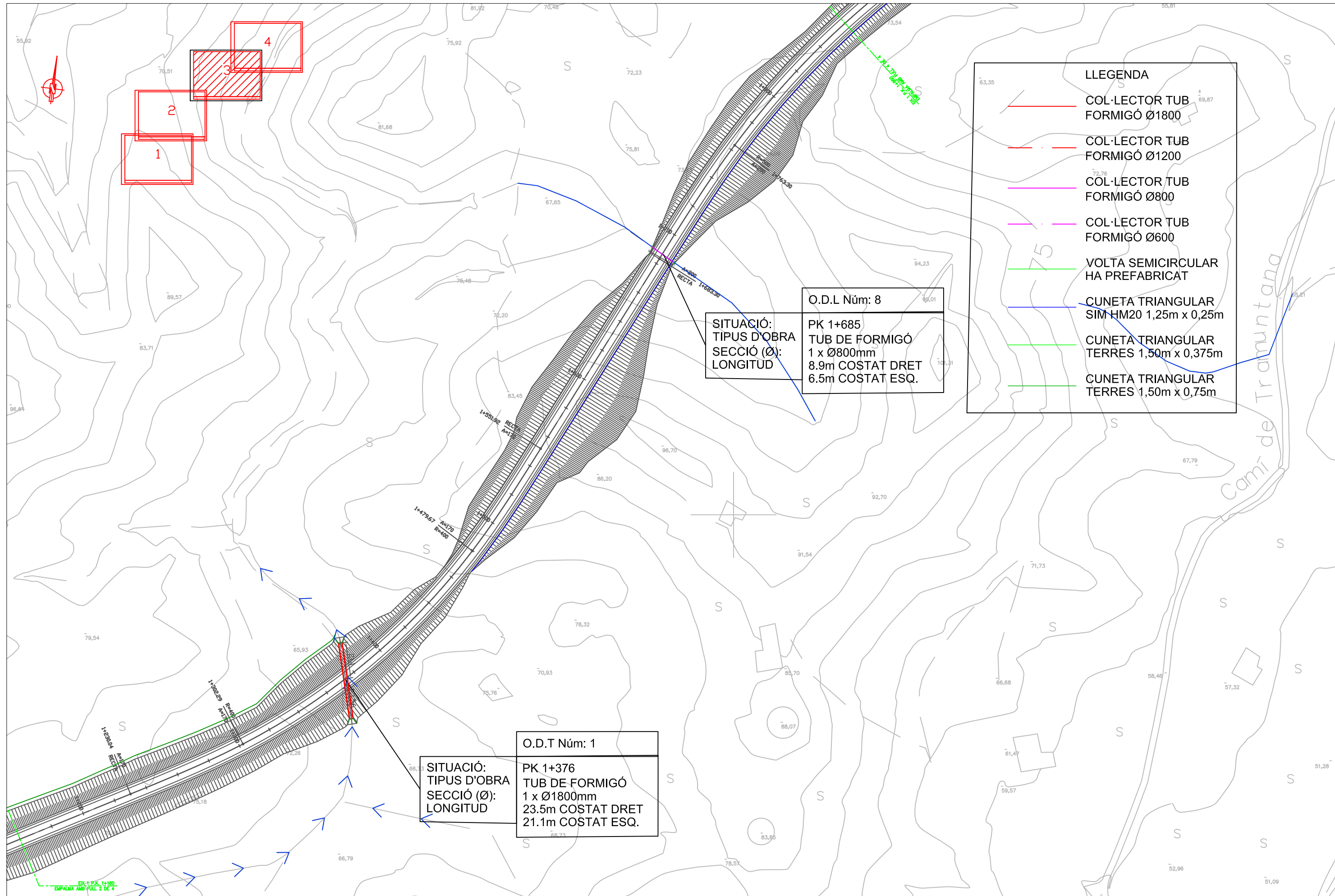

Títol del projecte: Projecte de variant entre la Me-1 i la Me15 al terme municipal de Mercadal (Menorca)	Autor: Pons Florit, Neus	Tutor: Fernandez de Villalta Ferrer-Dalmau, Eduardo	Títol del plànol: Drenatge Plantes	Escala A3: 1:2000	Plànol núm: 10A 3 de 4 Data: Setembre 2015
---	-----------------------------	--	---------------------------------------	----------------------	---

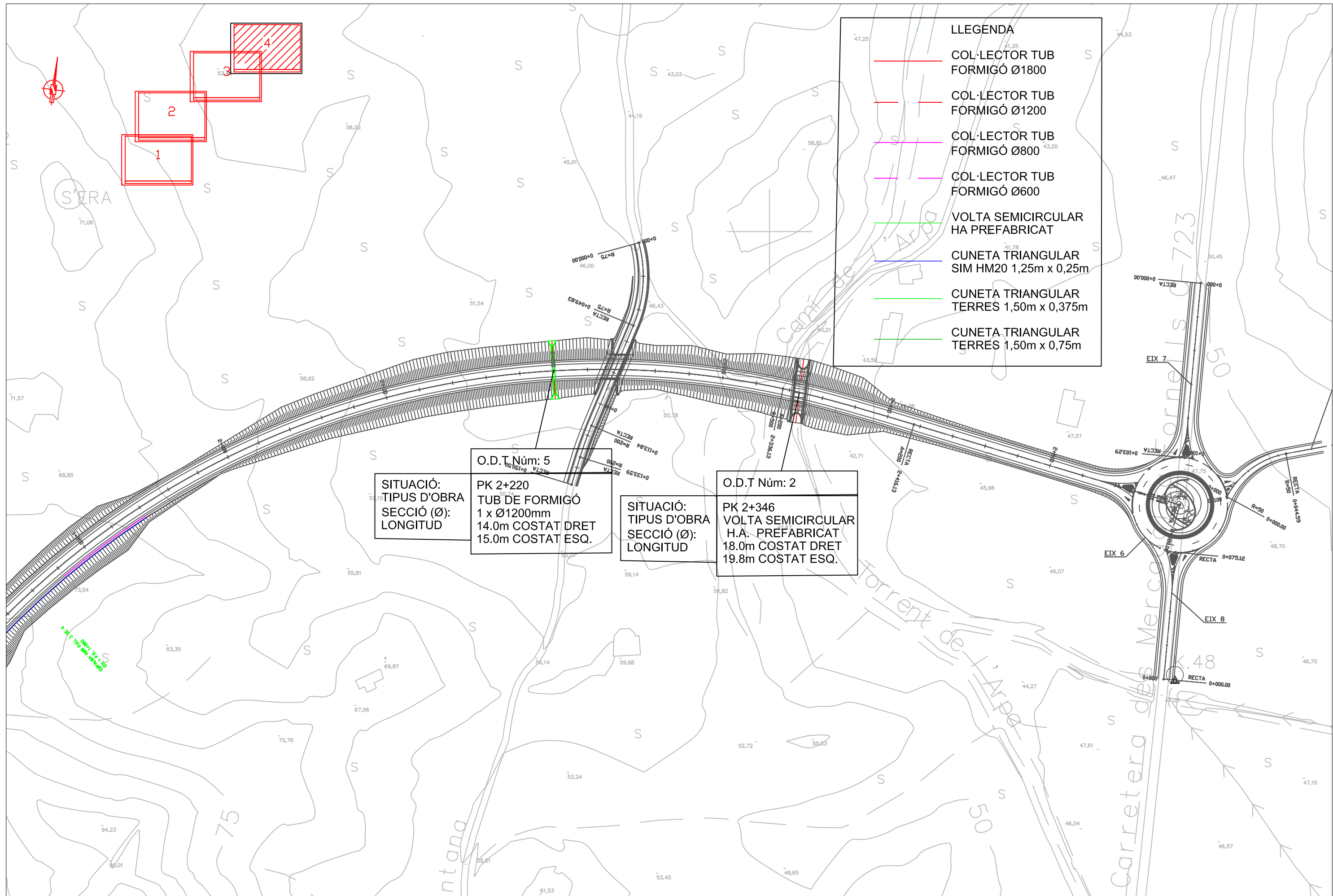

LLEENDA	
	COL·LECTOR TUB FORMIGÓ Ø1800
	COL·LECTOR TUB FORMIGÓ Ø1200
	COL·LECTOR TUB FORMIGÓ Ø800
	COL·LECTOR TUB FORMIGÓ Ø600
	VOLTA SEMICIRCULAR HA PREFABRICAT
	CUNETA TRIANGULAR SIM HM20 1,25m x 0,25m
	CUNETA TRIANGULAR TERRES 1,50m x 0,375m
	CUNETA TRIANGULAR TERRES 1,50m x 0,75m

O.D.T. Núm: 5  
 SITUACIÓ:  
 TIPUS D'OBRA  
 SECCIÓ (Ø):  
 LONGITUD  
 PK 2+220  
 TUB DE FORMIGÓ  
 1 x Ø1200mm  
 14.0m COSTAT DRET  
 15.0m COSTAT ESQ.

O.D.T. Núm: 2  
 SITUACIÓ:  
 TIPUS D'OBRA  
 SECCIÓ (Ø):  
 LONGITUD  
 PK 2+346  
 VOLTA SEMICIRCULAR  
 H.A. PREFABRICAT  
 18.0m COSTAT DRET  
 19.8m COSTAT ESQ.

Títol del projecte:  
 Projecte de variant entre la Me-1 i la Me15 al terme municipal de Mercadal (Menorca)

Autor:  
 Pons Florit, Neus

Tutor:  
 Fernandez de Villalta Ferrer-Dalmau, Eduardo

Títol del plànol:  
 Drenatge Plantes

Escala A3:  
 1:2000

Plànol núm:  
 10A 4 de 4  
 Data:  
 Setembre 2015



DOVELES PREFABRICATS DE FORMIGÓ ARMAT  
ESCALA 1/150

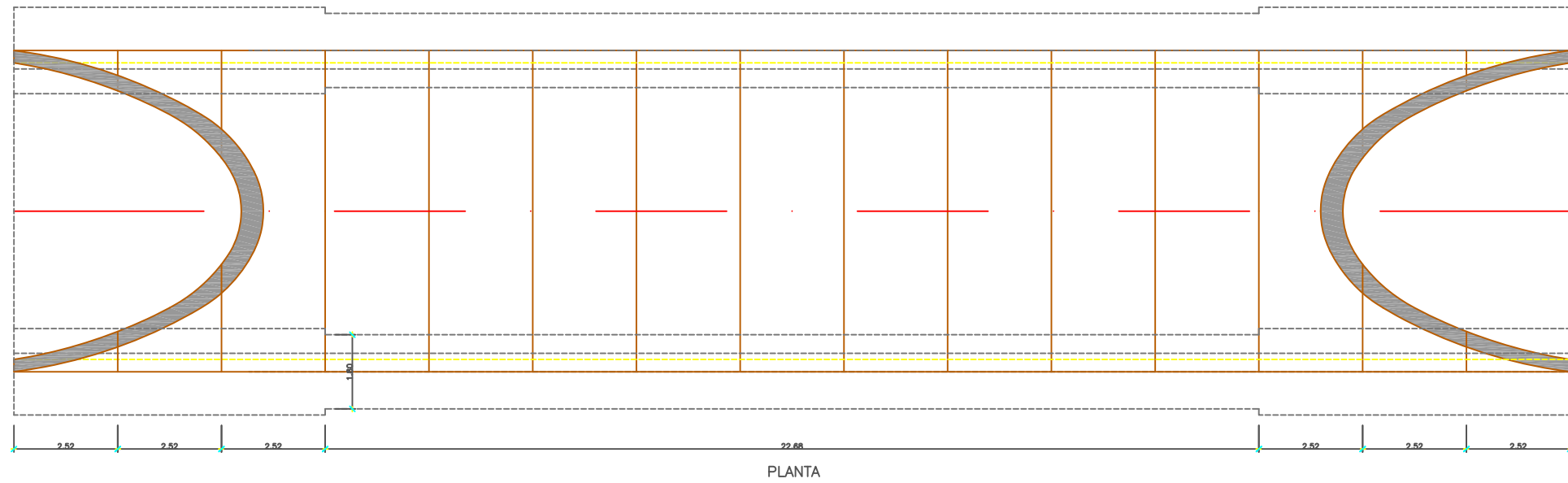
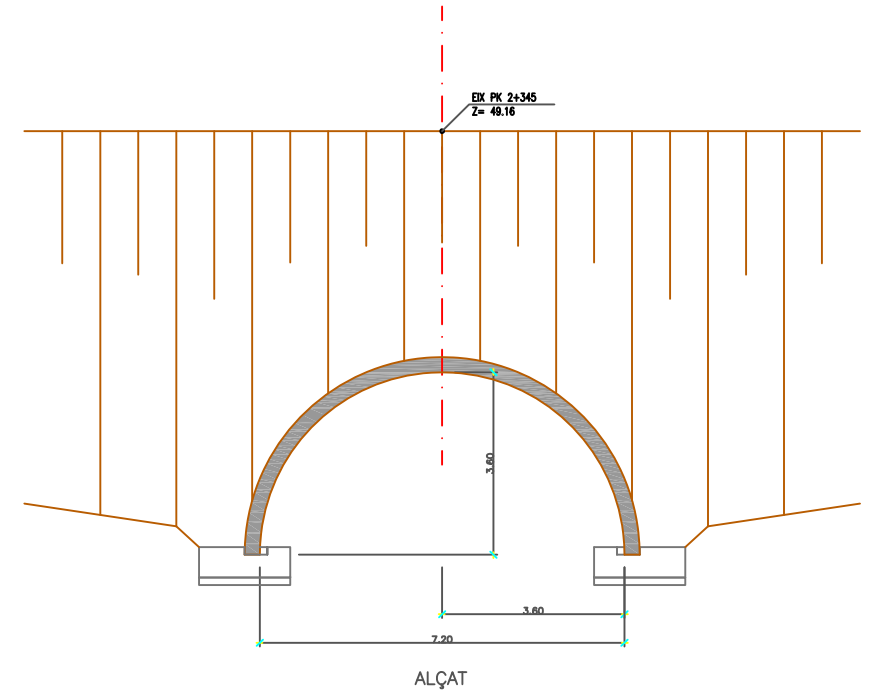
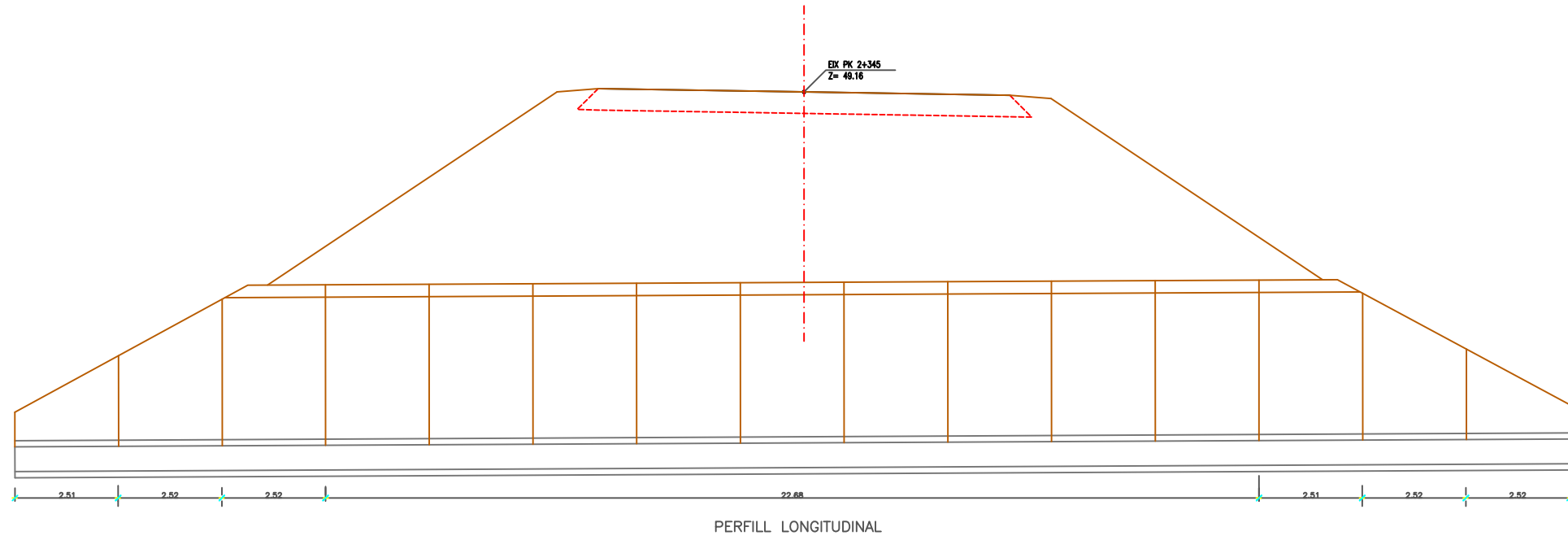

CONTROL DE QUALITAT		NIVELL	COEFICIENT
FORMIGÓ	RESECA I ANIVELLAMENT	H8-20/P/20/Ra	REDUT
	BARRES I ALÇATS	H4-25/P/20/Ra	Y=1.50
	PREFABRICATS	H4-35/P/20/Ra	Y=1.50
ACER	BARRES CORROSIONES	S 500 S	NORMAL
			Y=1.15
EDEUCO	DARVIS MITJANS		Y=1.60

Títol del projecte:  
Projecte de variant entre la Me-1 i la Me15 al terme municipal de Mercadal (Menorca)

Autor:  
Pons Florit, Neus

Tutor:  
Fernandez de Villalta Ferrer-Dalmau, Eduardo

Títol del plànol:  
Drenatge Detalls  
ODT PK 2+346

Escala A3:  
1:2000

Plànol núm:  
10B 1 de 2  
Data:  
Setembre 2015

SECCIÓ TIPUS VOLTA FORMIGÓ ARMAT R=3.60m  
DOVELLES SEMICIRCULARS DE FORMIGÓ PREFABRICADES

DEFINICIÓ GEOMÈTRICA

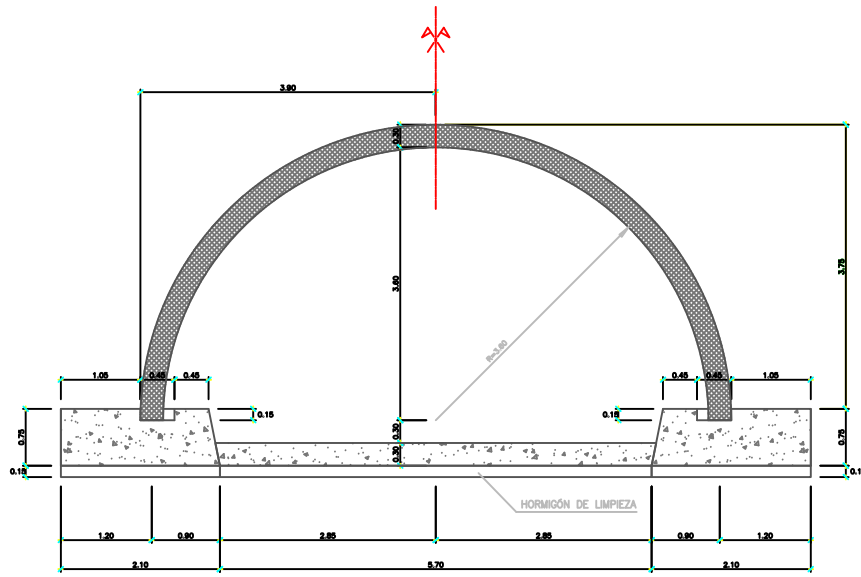

ARMADO

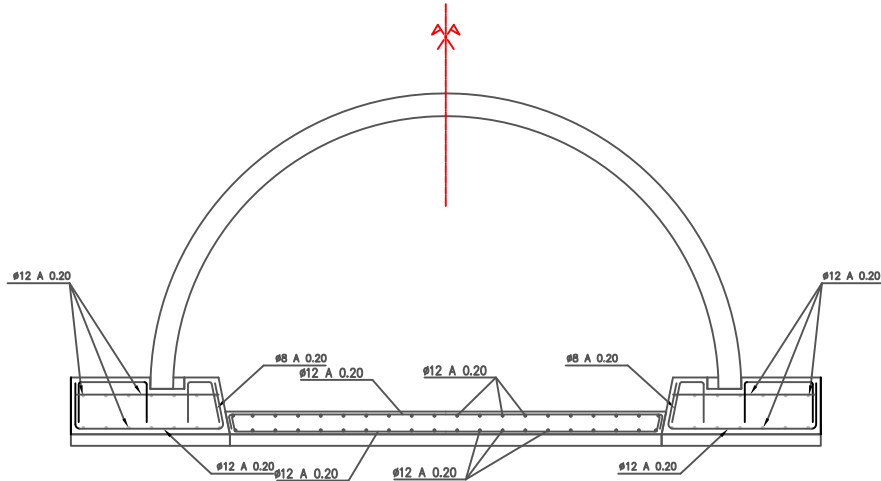

SECCIÓ TIPUS PIC DE FLAUTA FORMIGÓ ARMAT R=3.60m  
DOVELLES EN MÈNSULA DE FORMIGÓ PREFABRICADES

DEFINICIÓ GEOMÈTRICA

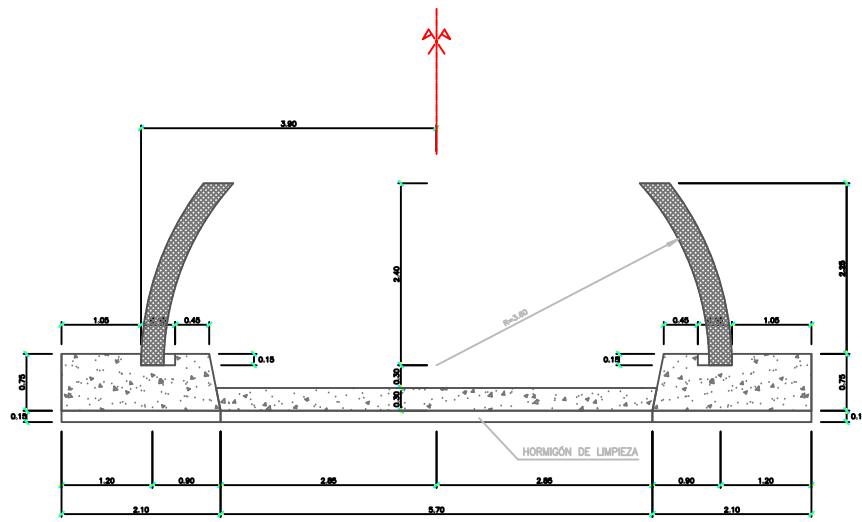

ARMADO

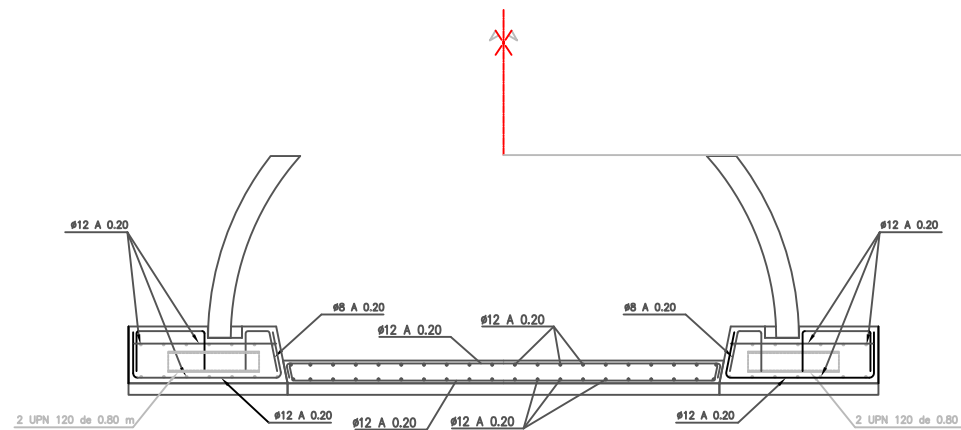

SECCIÓ TIPUS PIC DE FLAUTA FORMIGÓ ARMAT R=3.60m  
DOVELLES EN MÈNSULA DE FORMIGÓ PREFABRICADES

DEFINICIÓ GEOMÈTRICA

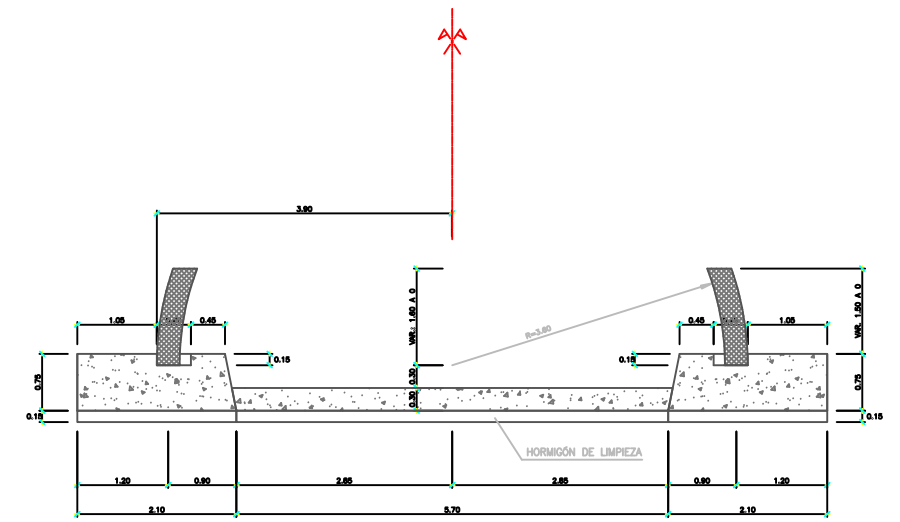

ARMADO

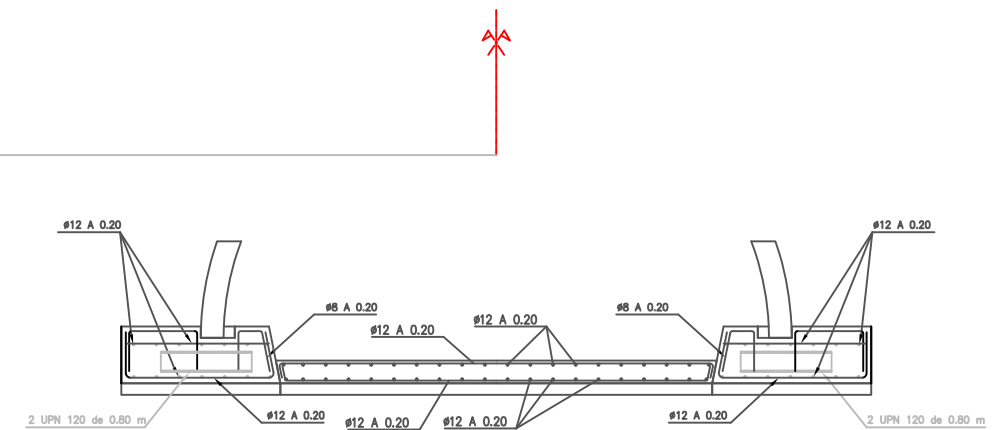

CARACTERÍSTICAS DE LOS MATERIALES								
ELEMENTO	HORMIGÓN			ACERO			EJECUCIÓN	
	TIPO	CONTROL	C	TIPO	CONTROL	C	CONTROL	F
HORMIGÓN EN MASA	HM-20/P/20/10	NORMAL	1,5	—	—	—	—	—
ZAPATAS	HA-25/P/20/10	NORMAL	1,5	B 500 S	NORMAL	1,15	NORMAL	1,5
ALZADOS	HA-25/P/20/10	NORMAL	1,5	B 500 S	NORMAL	1,15	NORMAL	1,5

SECCIÓ TIPUS ENDEGAMENT TORRENT EN TERRES. A=7.50m; H=1,50m  
MURS DE CONTENCIÓ EN PIEDRA SECA

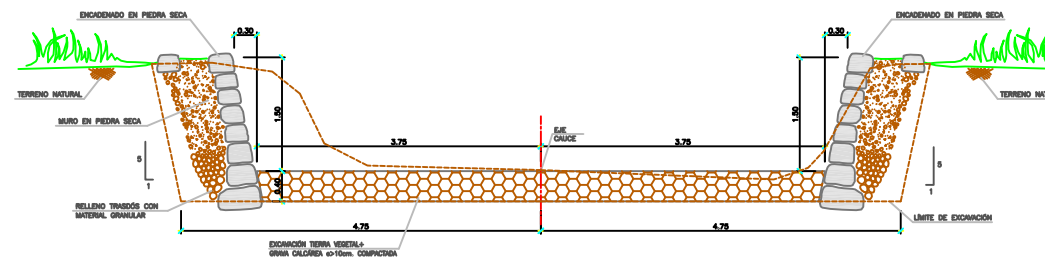

Títol del projecte:  
Projecte de variant entre la Me-1 i la Me15 al terme municipal de Mercadal (Menorca)

Autor:  
Pons Florit, Neus

Tutor:  
Fernandez de Villalta Ferrer-Dalmau, Eduardo

Títol del plànol:  
Drenatge Detalls  
ODT PK 2+346

Escala A3:  
1:2000

Plànol núm:  
10B 2 de 2  
Data:  
Setembre 2015

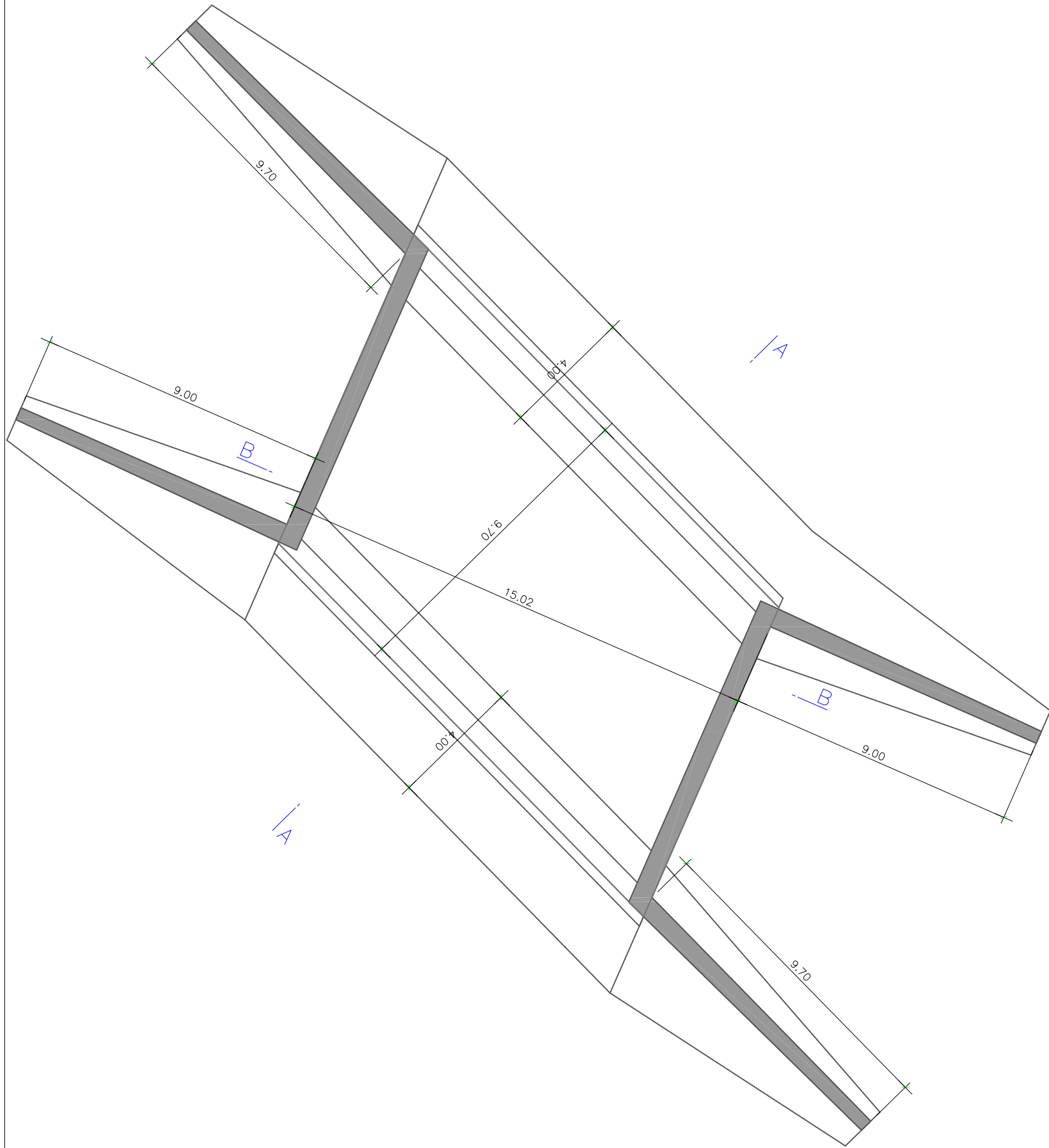

PLANTA  
ESCALA 1:150

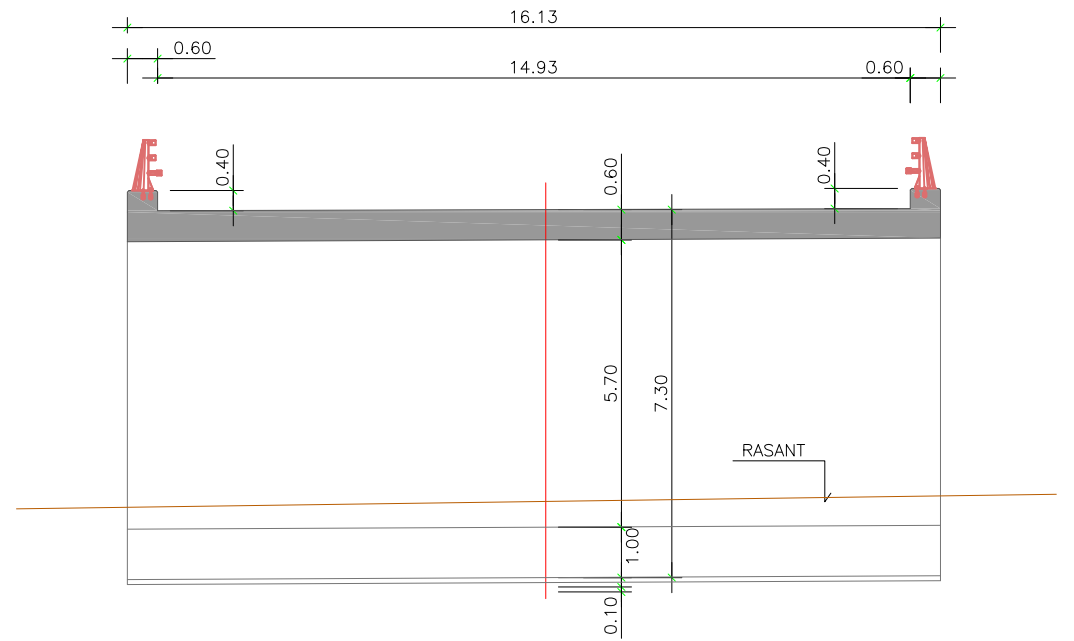

SECCIÓN LONGITUDINAL B-B  
ESCALA 1:150

Títol del projecte:  
Projecte de variant entre la Me-1 i la Me15 al terme municipal de Mercadal (Menorca)

Autor:  
Pons Florit, Neus

Tutor:  
Fernandez de Villalta Ferrer-Dalmau, Eduardo

Títol del plànol:  
Estructures Planta  
PK 0+875

Escala A3:  
1:150

Plànol núm:  
11A 1 de 5  
Data:  
Setembre 2015

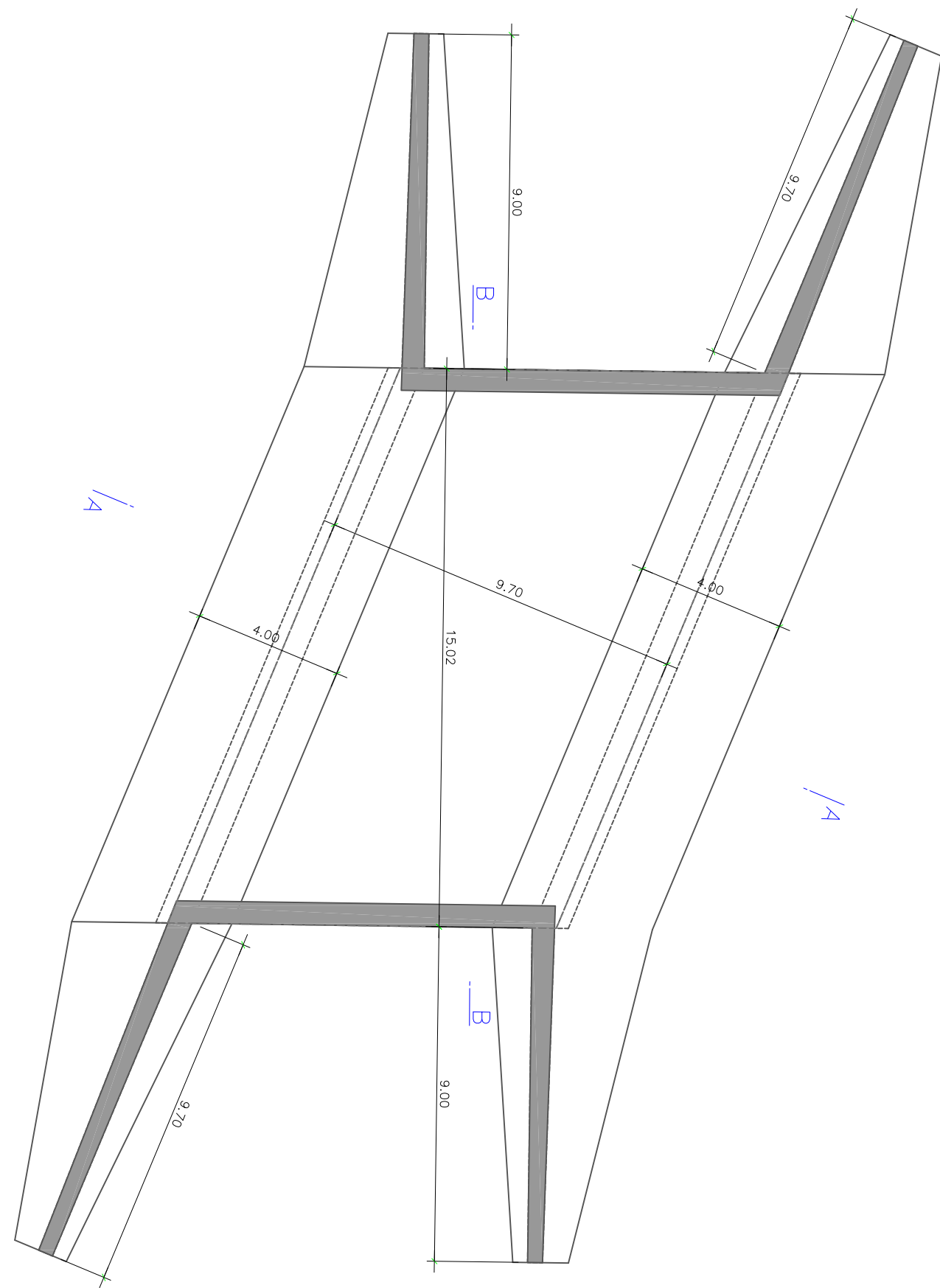

PLANTA  
ESCALA 1:150

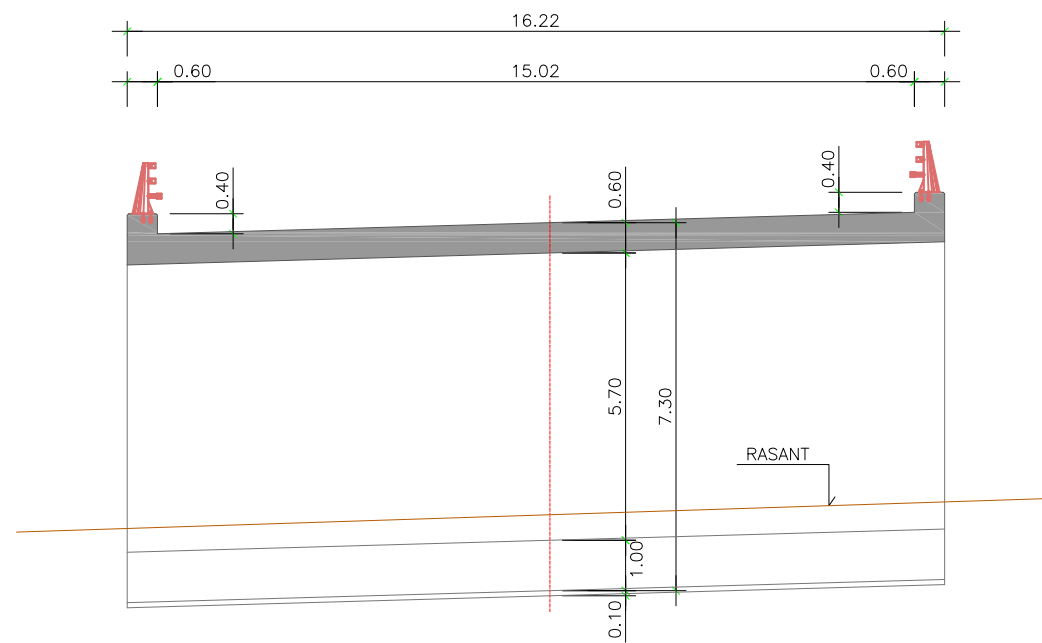

SECCIÓN LONGITUDINAL B-B  
ESCALA 1:150

Títol del projecte:  
Projecte de variant entre la Me-1 i la Me15 al terme municipal de Mercadal (Menorca)

Autor:  
Pons Florit, Neus

Tutor:  
Fernandez de Villalta Ferrer-Dalmau, Eduardo

Títol del plànol:  
Estructures Planta  
PK 2+335

Escala A3:  
1:150

Plànol núm:  
11A 2 de 5  
Data:  
Setembre 2015

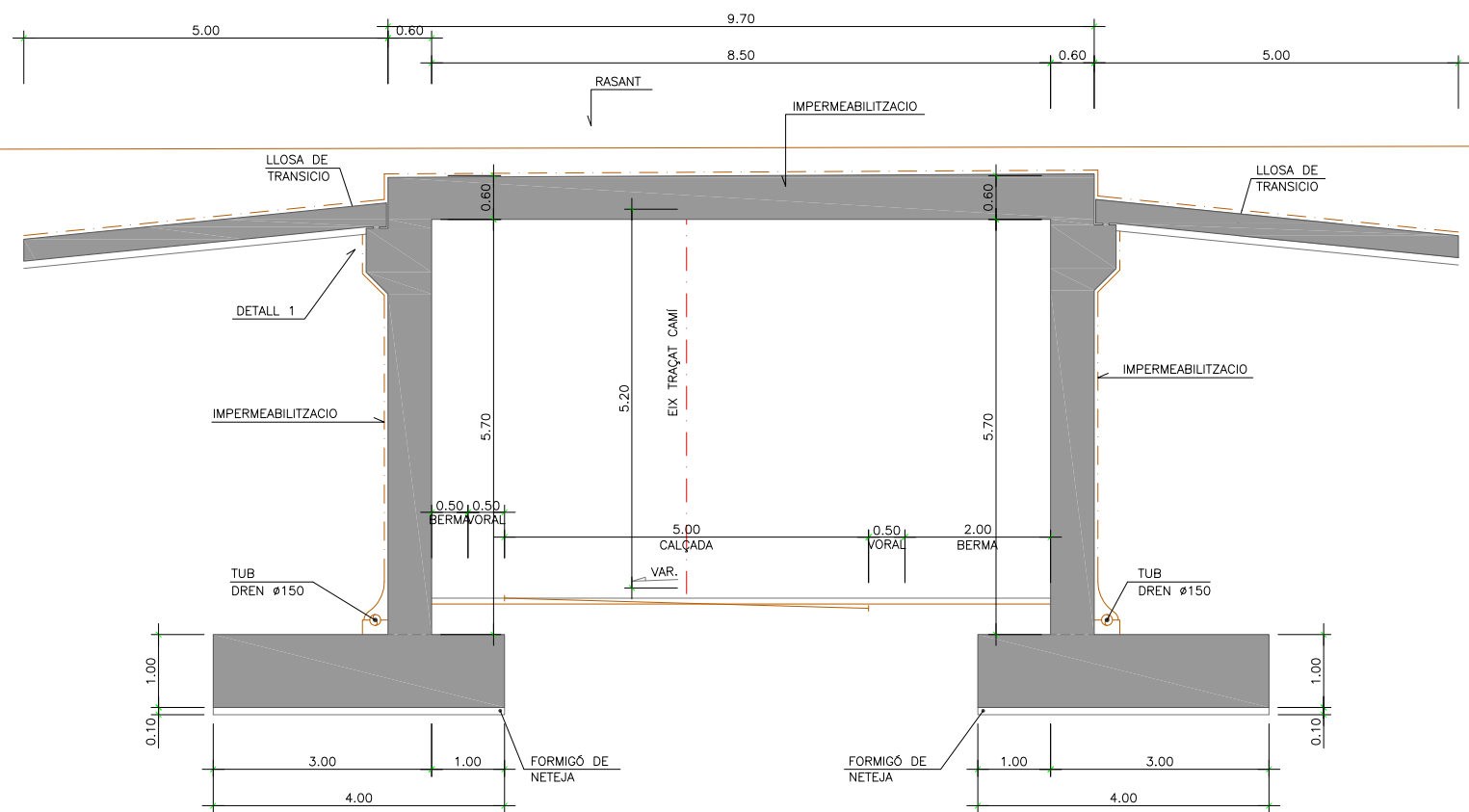

SECCIÓ TRANSVERSAL A-A  
ESCALA 1:100

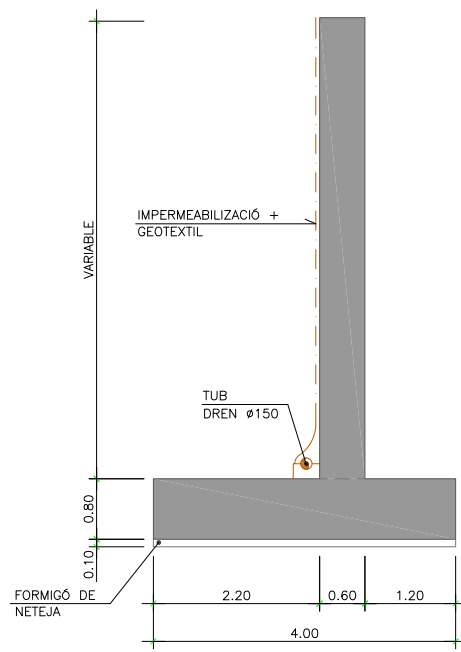

SECCIÓ ALETA  
ESCALA 1:100

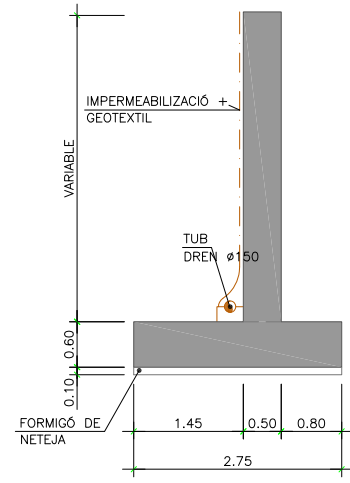

SECCIÓ ALETA  
ESCALA 1:100

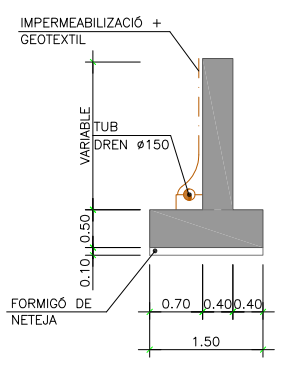

SECCIÓ ALETA  
ESCALA 1:100

Títol del projecte:  
Projecte de variant entre la Me-1 i la Me15 al terme municipal de Mercadal (Menorca)

Autor:  
Pons Florit, Neus

Tutor:  
Fernandez de Villalta Ferrer-Dalmau, Eduardo

Títol del plànol:  
Estructures Detalls ODT PK 0+875

Escala A3:  
1:100

Plànol n.º:  
11B 3 de 5  
Data:  
Setembre 2015

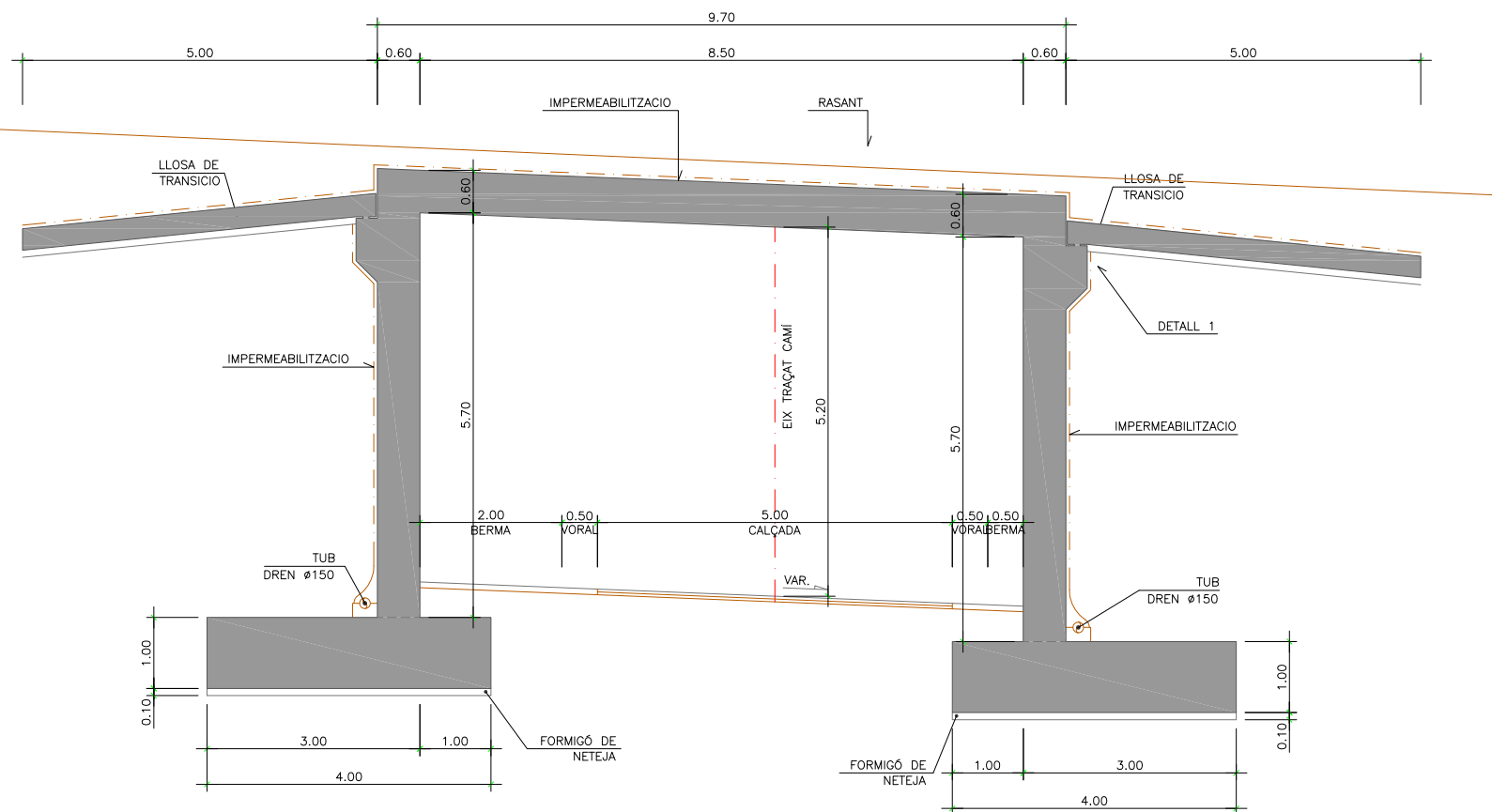

SECCIÓ TRANSVERSAL A-A  
ESCALA 1:100

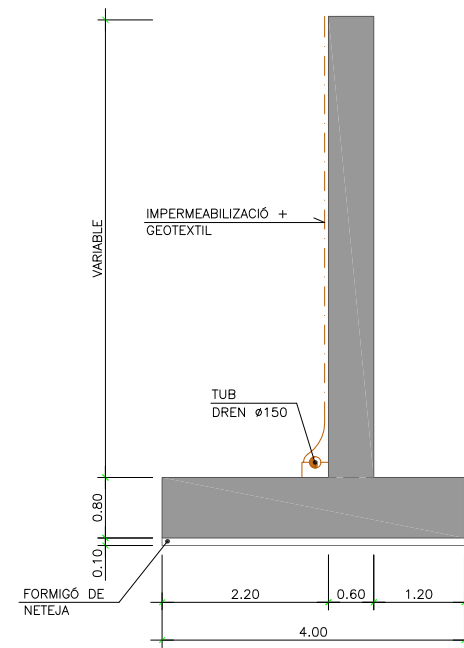

SECCIÓ ALETA  
ESCALA 1:100

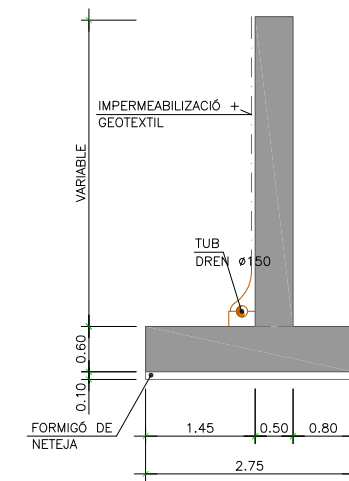

SECCIÓ ALETA  
ESCALA 1:100

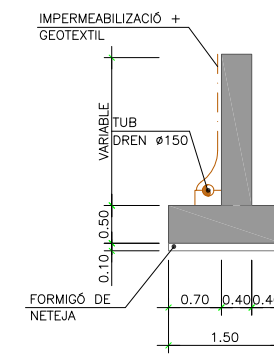

SECCIÓ ALETA  
ESCALA 1:100

Títol del projecte:  
Projecte de variant entre la Me-1 i la Me15 al terme municipal de Mercadal (Menorca)

Autor:  
Pons Florit, Neus

Tutor:  
Fernandez de Villalta Ferrer-Dalmau, Eduardo

Títol del plànol:  
Estructura Detalls  
ODT PK 2+335

Escala A3:  
1:100

Plànol n.º:  
11A 4 de 5  
Data:  
Setembre 2015

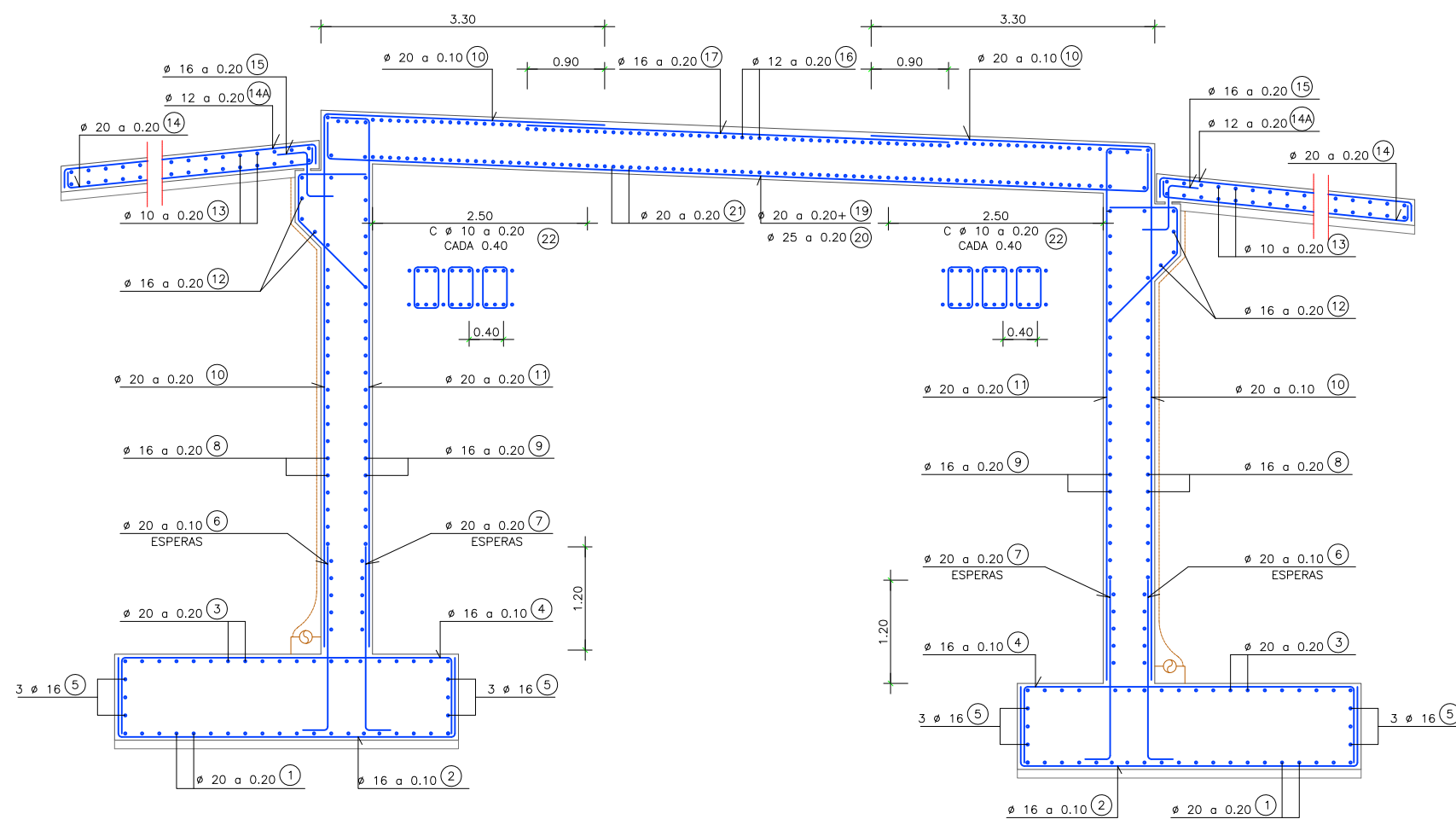

ARMAT SECCIÓ TRANSVERSAL A-A  
ESCALA 1:75

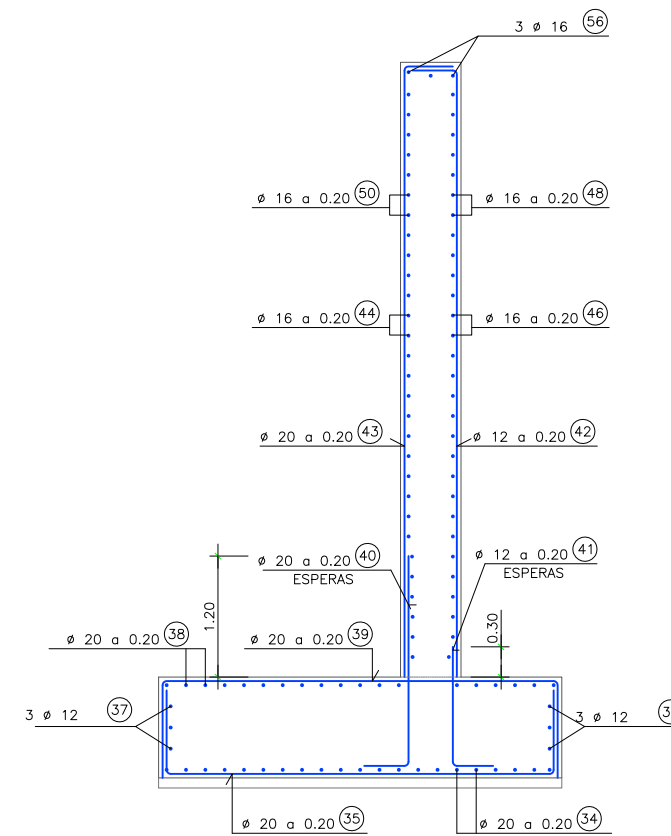

ARMAT SECCIÓ ALETA  
ESCALA 1:75

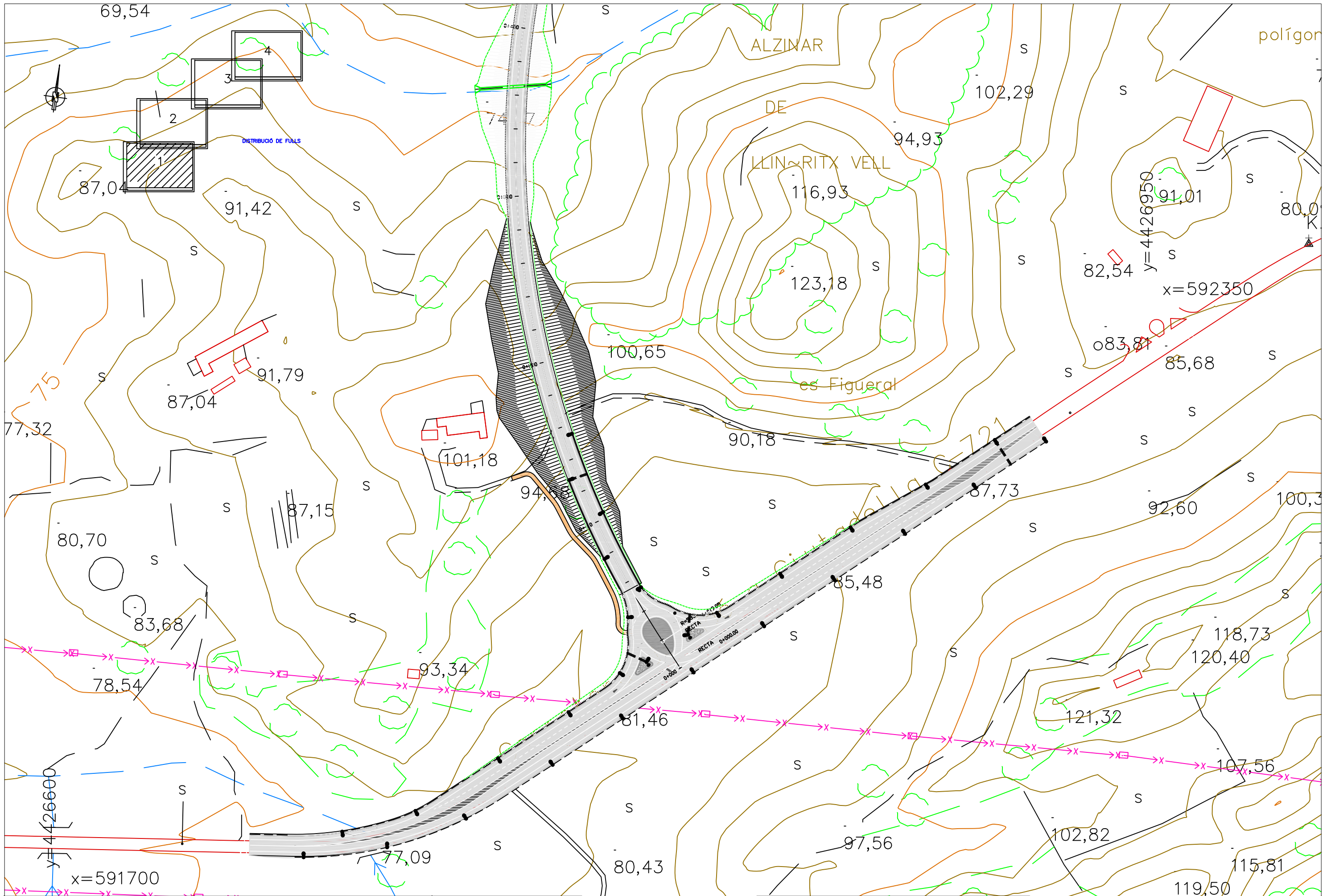

Títol del projecte: Projecte de variant entre la Me-1 i la Me15 al terme municipal de Mercadal (Menorca)	Autor: Pons Florit, Neus	Tutor: Fernandez de Villalta Ferrer-Dalmau, Eduardo	Títol del plànol: Enllumenat	Escala A3: 1:2000	Plànol núm: 12A 1 de 2 Data: Setembre 2015
---	-----------------------------	--	---------------------------------	----------------------	---



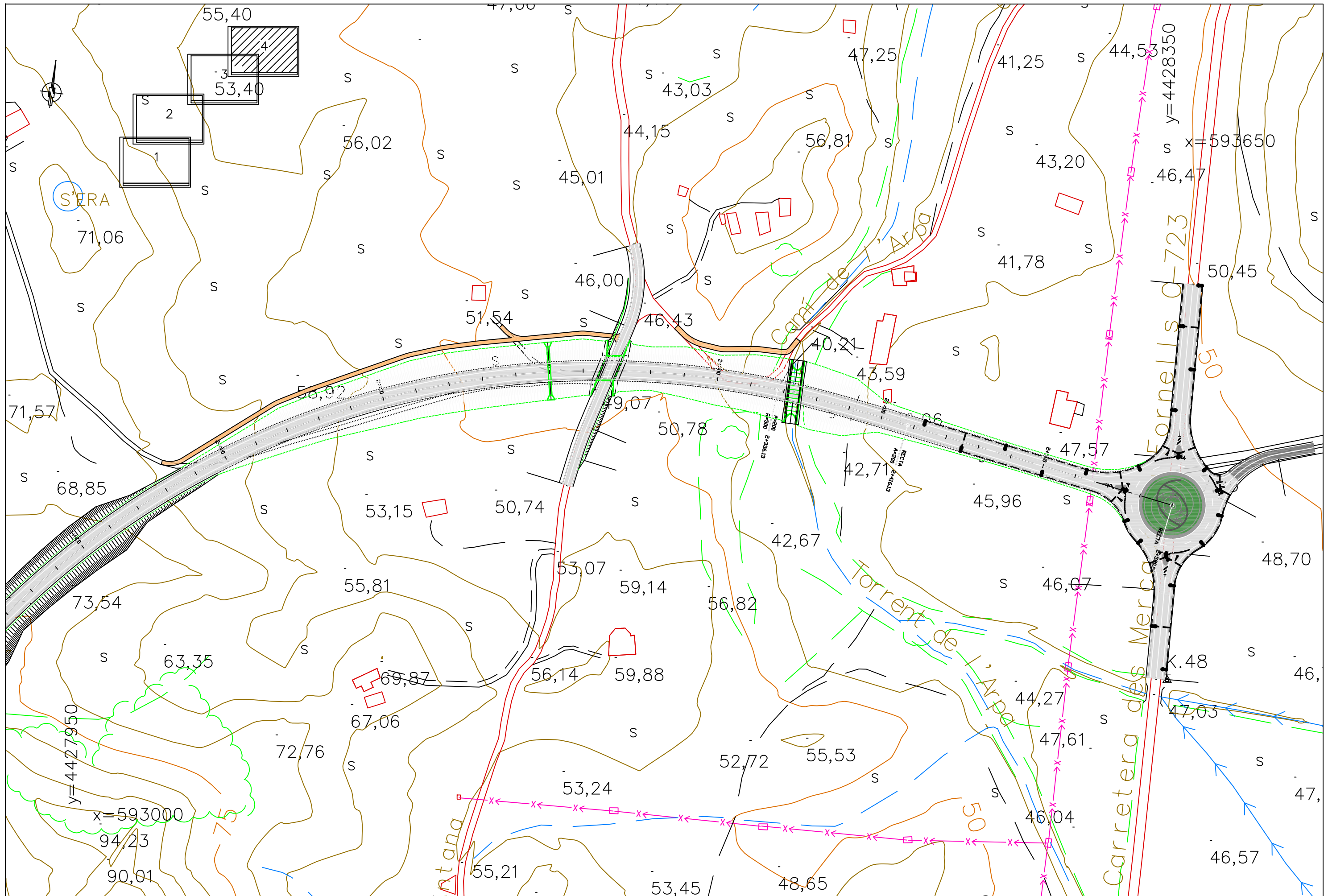

Títol del projecte: Projecte de variant entre la Me-1 i la Me15 al terme municipal de Mercadal (Menorca)	Autor: Pons Florit, Neus	Tutor: Fernandez de Villalta Ferrer-Dalmau, Eduardo	Títol del plànol: Enllumenat	Escala A3: 1:2000	Plànol núm: 12A 2 de 2 Data: Setembre 2015
---	-----------------------------	--	---------------------------------	----------------------	---

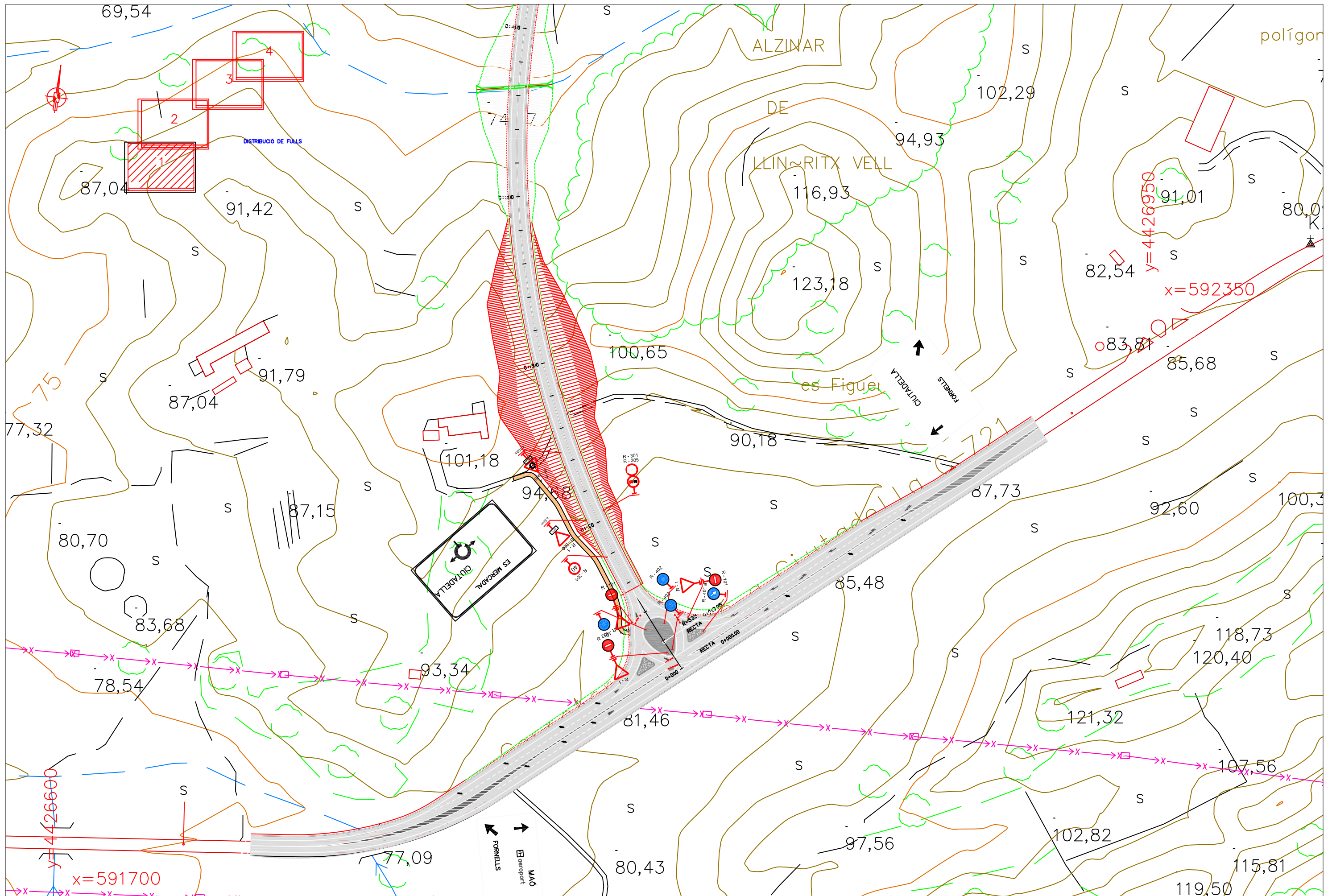

Títol del projecte: Projecte de variant entre la Me-1 i la Me15 al terme municipal de Mercadal (Menorca)	Autor: Pons Florit, Neus	Tutor: Fernandez de Villalta Ferrer-Dalmau, Eduardo	Títol del plànol: Senyalització	Escala A3: 1:2000	Plànol núm: 13A 1 de 4 Data: Setembre 2015
---	-----------------------------	--	------------------------------------	----------------------	---

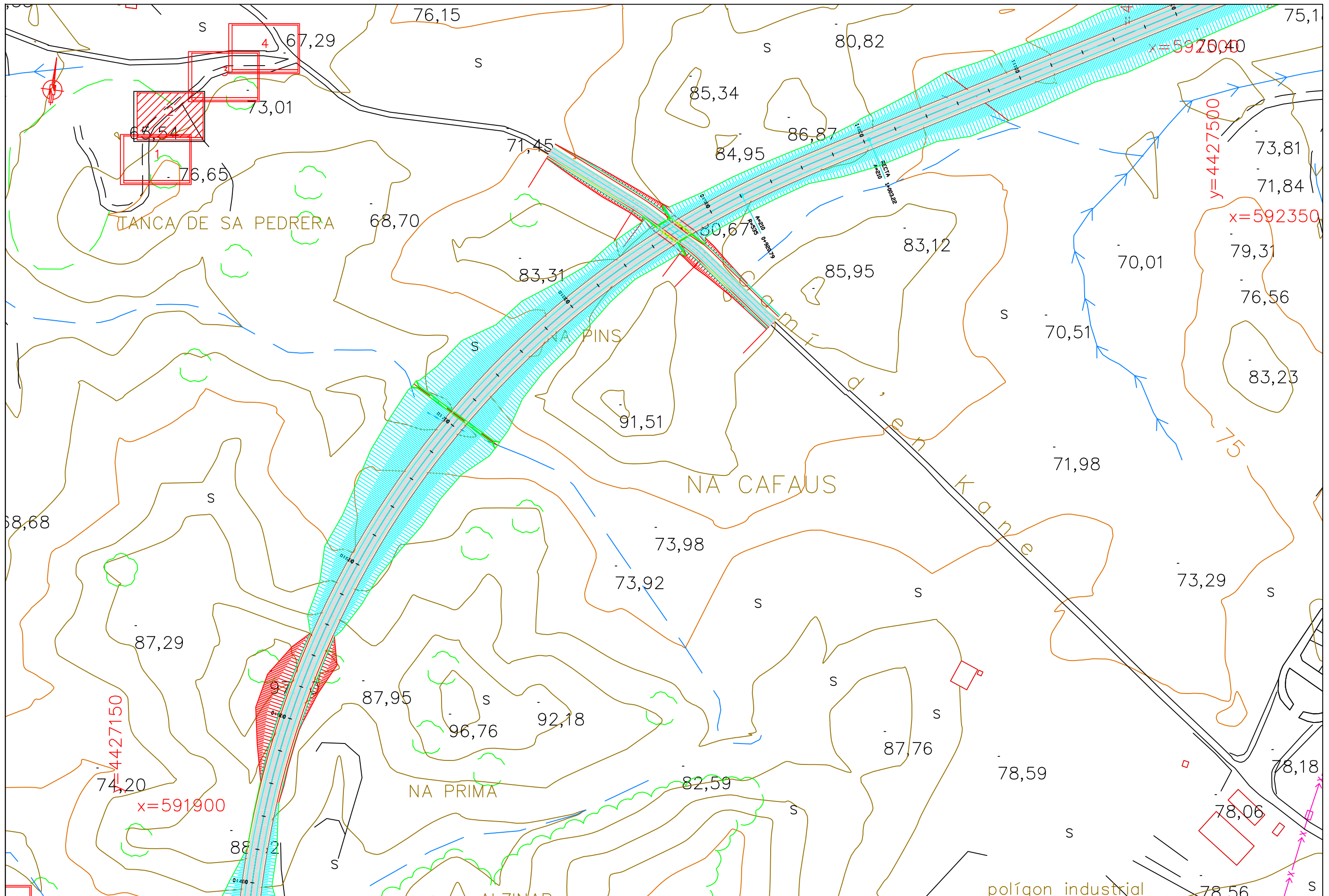

Títol del projecte: Projecte de variant entre la Me-1 i la Me15 al terme municipal de Mercadal (Menorca)	Autor: Pons Florit, Neus	Tutor: Fernandez de Villalta Ferrer-Dalmau, Eduardo	Títol del plànol: Senyalització	Escala A3: 1:2000	Plànol núm: 13A 2 de 4 Data: Setembre 2015
---	-----------------------------	--	------------------------------------	----------------------	---

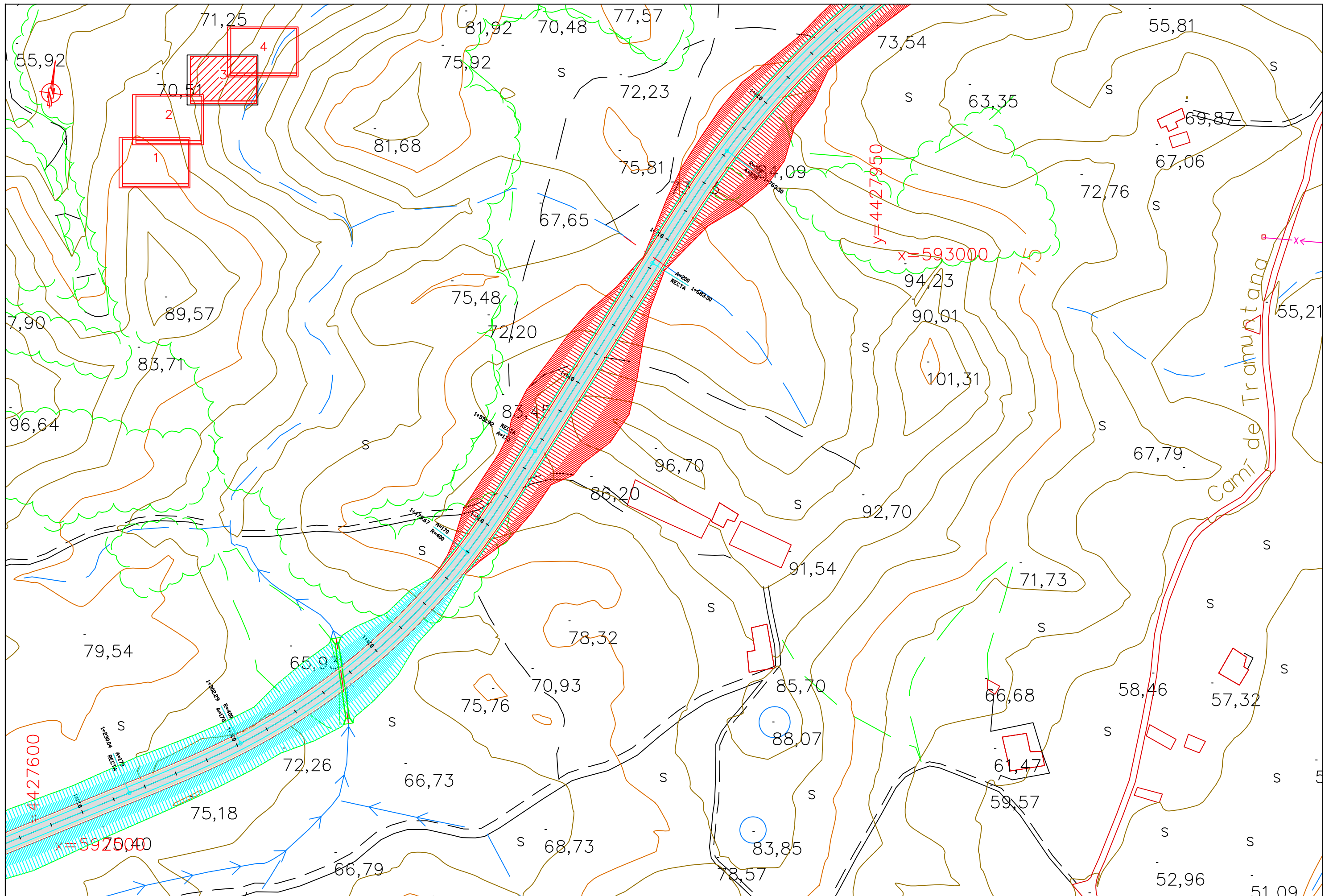

Títol del projecte: Projecte de variant entre la Me-1 i la Me15 al terme municipal de Mercadal (Menorca)	Autor: Pons Florit, Neus	Tutor: Fernandez de Villalta Ferrer-Dalmau, Eduardo	Títol del plànol: Senyalització	Escala A3: 1:2000	Plànol núm: 13A 3 de 4 Data: Setembre 2015
---	-----------------------------	--	------------------------------------	----------------------	---

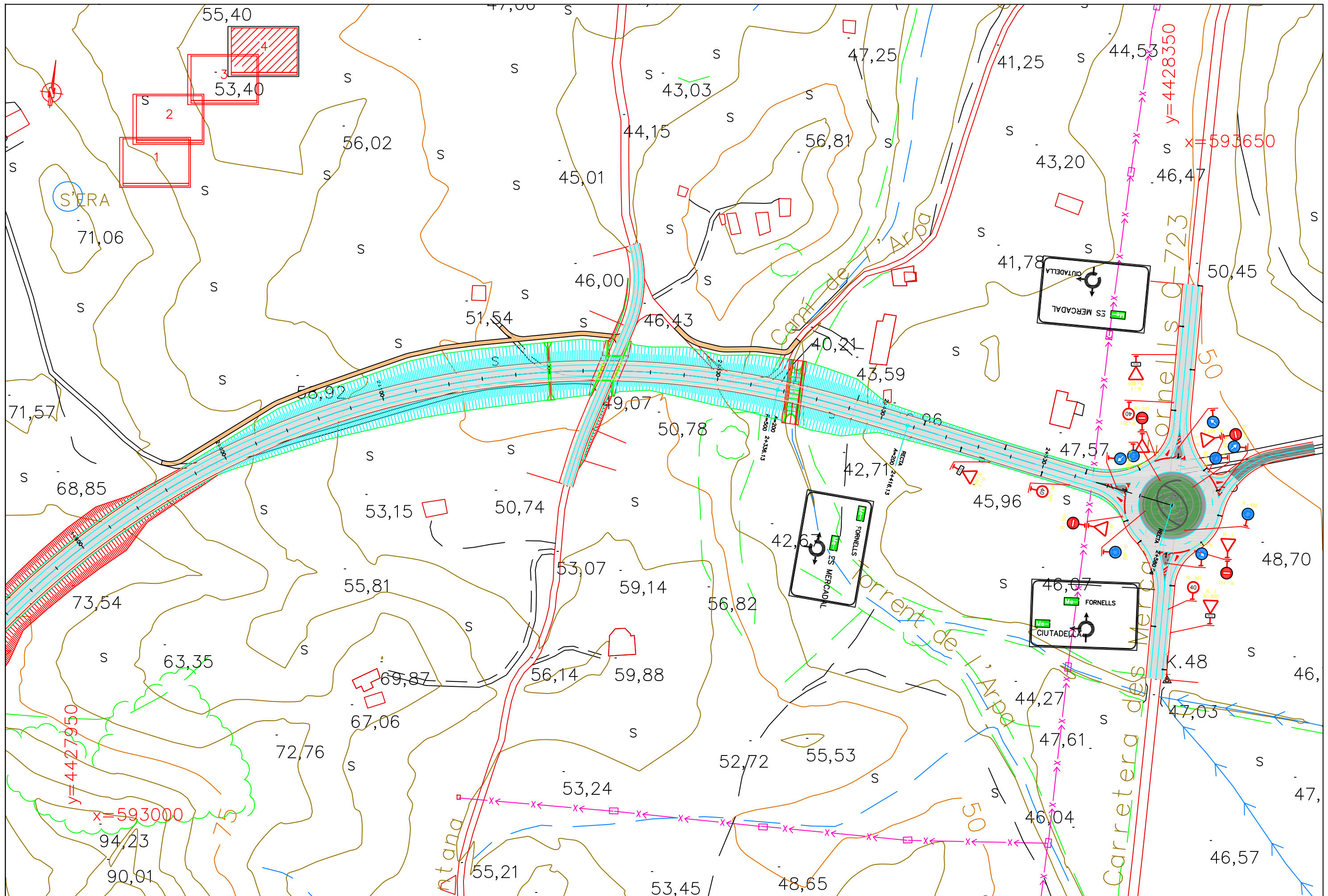

Títol del projecte: Projecte de variant entre la Me-1 i la Me15 al terme municipal de Mercadal (Menorca)	Autor: Pons Florit, Neus	Tutor: Fernandez de Villalta Ferrer-Dalmau, Eduardo	Títol del plànol: Senyalització	Escala A3: 1:2000	Plànol núm: 13A 4 de 4 Data: Setembre 2015
---	-----------------------------	--	------------------------------------	----------------------	---

## SENYALITZACIÓ LINES LONGITUDINALS DISCONTINUA (M-1)

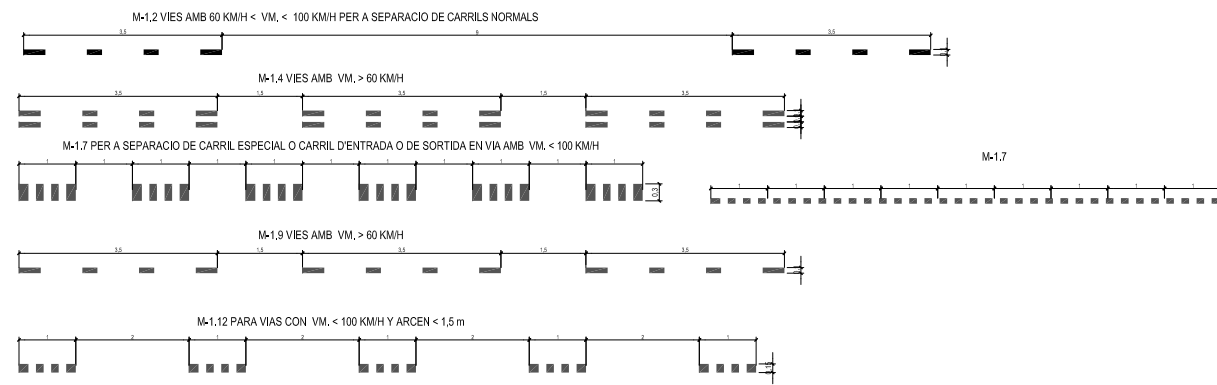

## SENYALITZACIÓ LINES LONGITUDINALS CONTINUA (M-2)

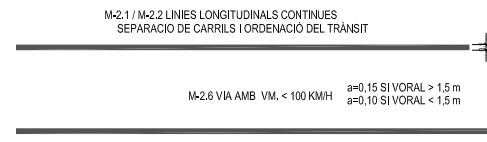

## SENYALITZACIÓ LINES LONGITUDINALS CONTINUA (M-3)

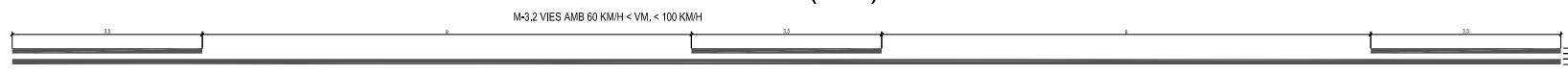

## SENYALITZACIÓ LINES (M-5)

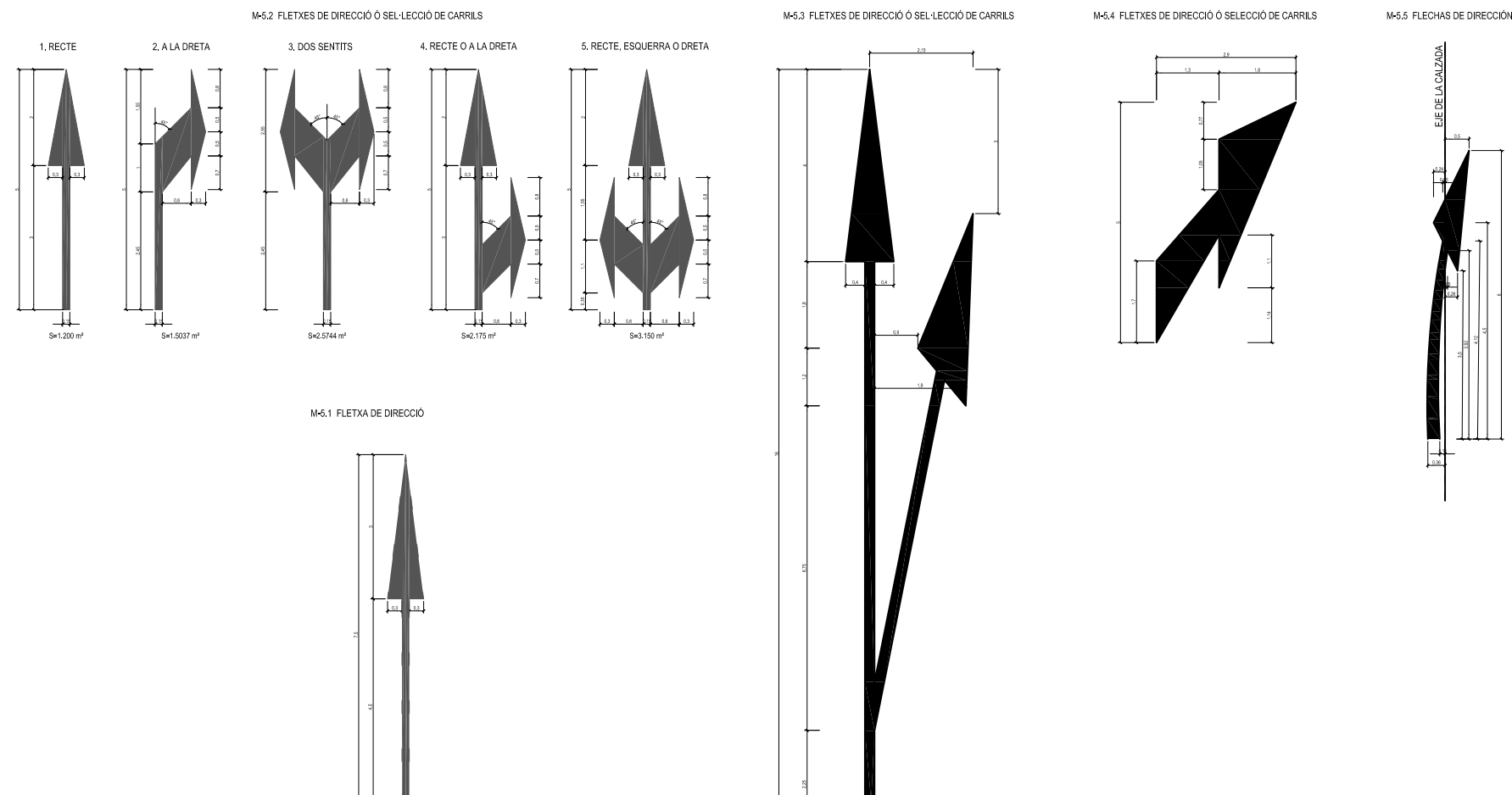

## SENYALITZACIÓ HORIZZONTAL (M-6)

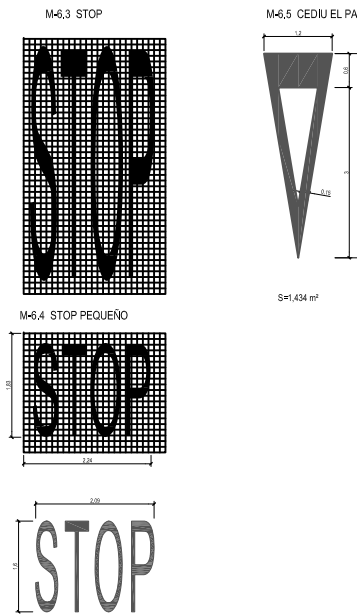

## SENYALITZACIÓ HORIZZONTAL (M-7)

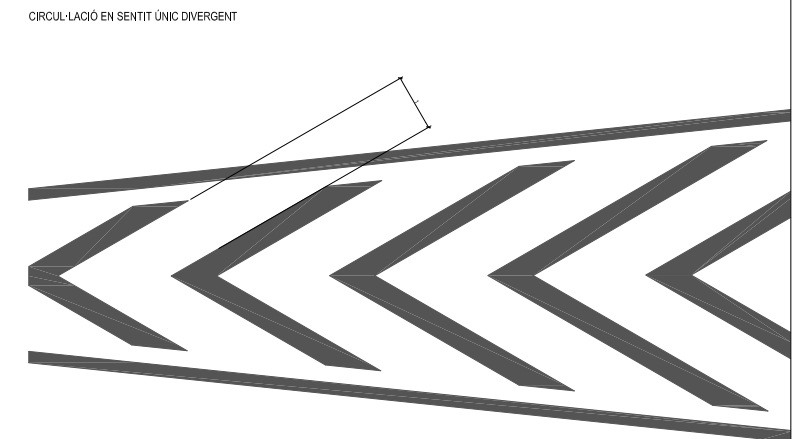
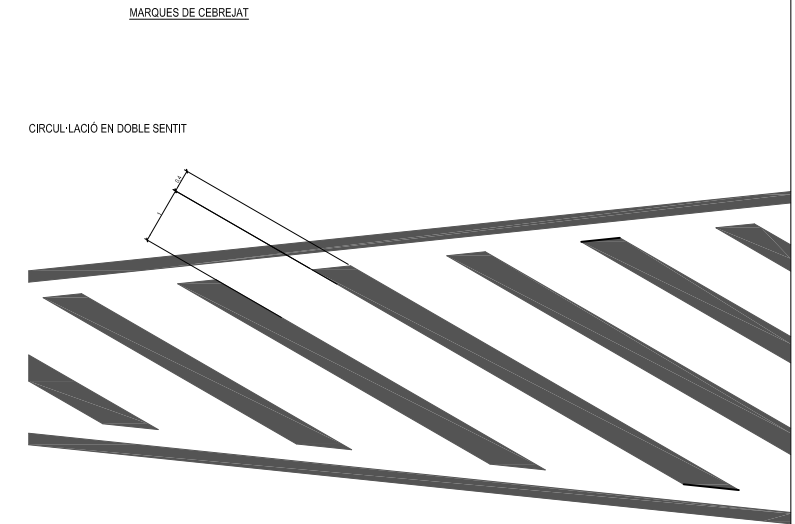

Títol del projecte:  
Projecte de variant entre la Me-1 i la Me15 al terme municipal de Mercadal (Menorca)

Autor:  
Pons Florit, Neus

Tutor:  
Fernandez de Villalta Ferrer-Dalmau, Eduardo

Títol del plànol:  
Senyalització

Escala A3:  
1:75

Plànol núm:  
13B 1 de 2  
Data:  
Setembre 2015

SENYALITZACIO VERTICAL

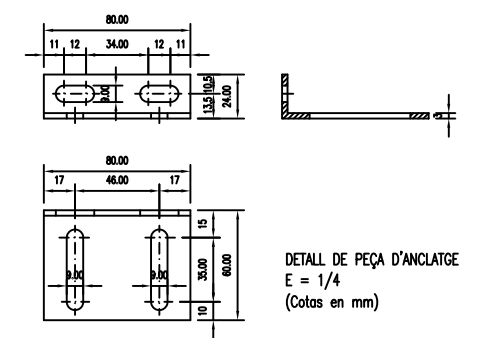
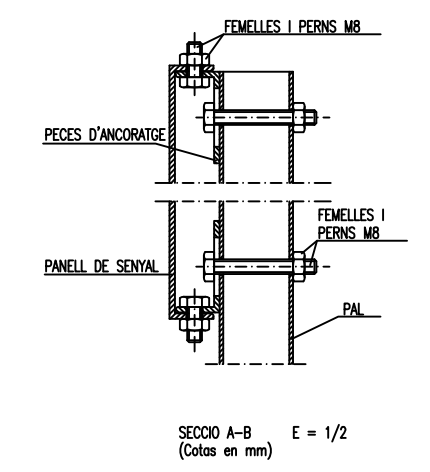
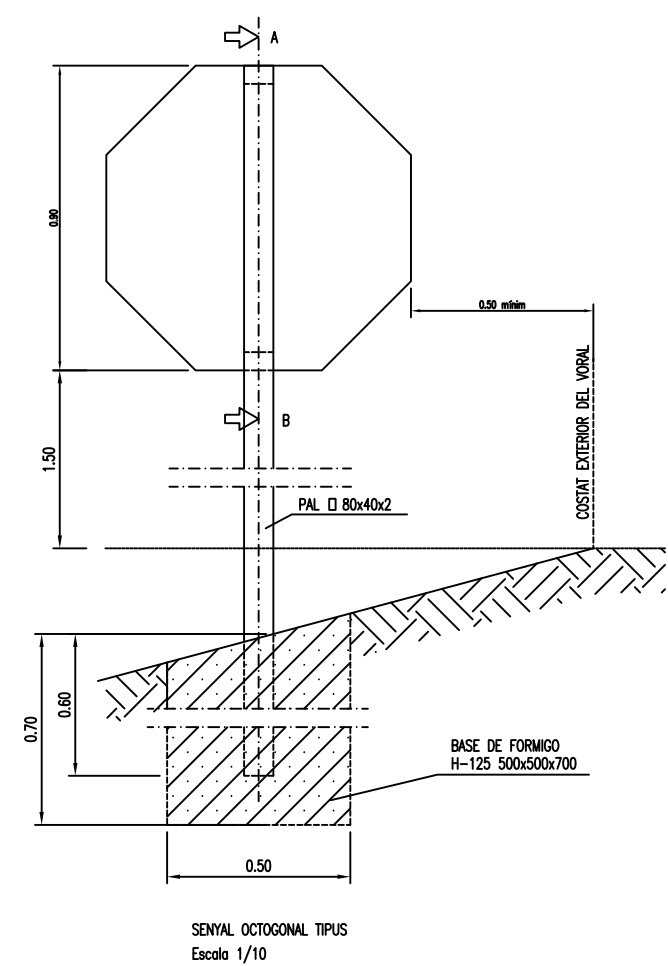
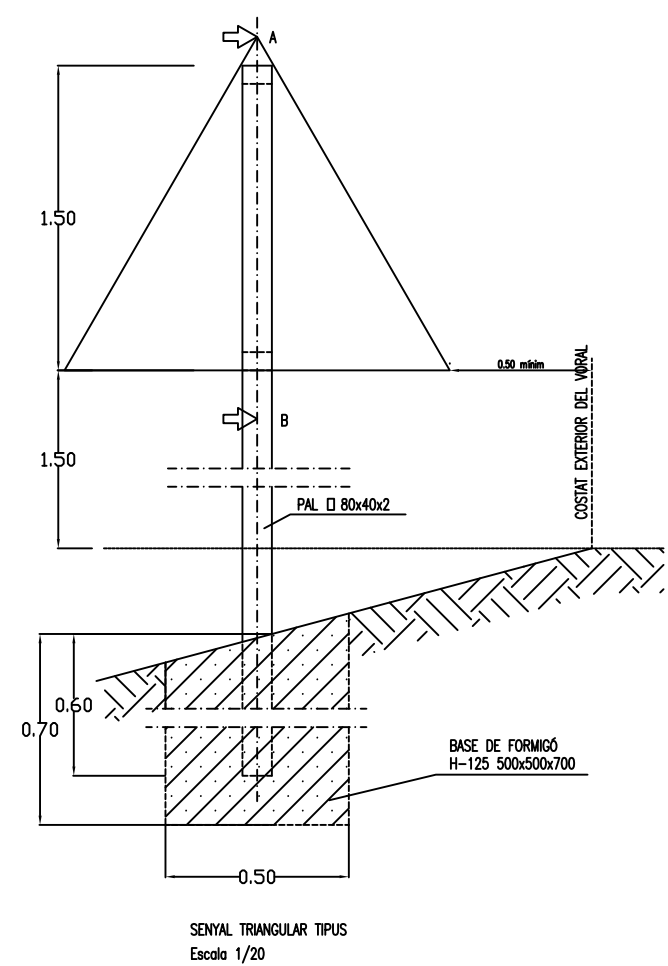
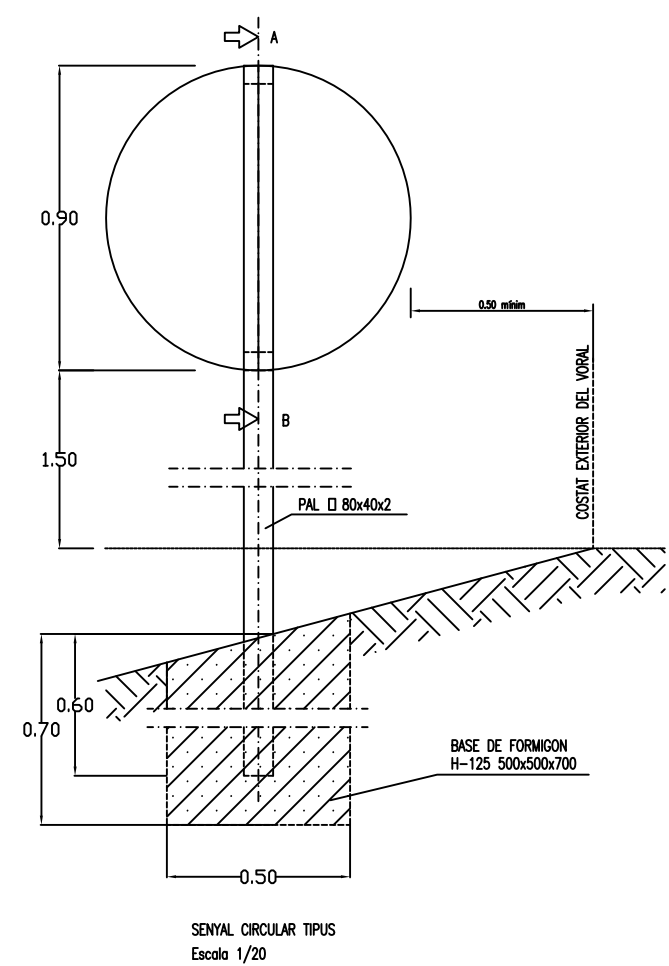

<p>Títol del projecte: Projecte de variant entre la Me-1 i la Me15 al terme municipal de Mercadal (Menorca)</p>	<p>Autor: Pons Florit, Neus</p>	<p>Tutor: Fernandez de Villalta Ferrer-Dalmau, Eduardo</p>	<p>Títol del plànol: Senyalització</p>	<p>Escala A3: S/E</p>	<p>Plànol núm: 13B 2 de 2 Data: Setembre 2015</p>
---	-------------------------------------	--	--	---------------------------	---

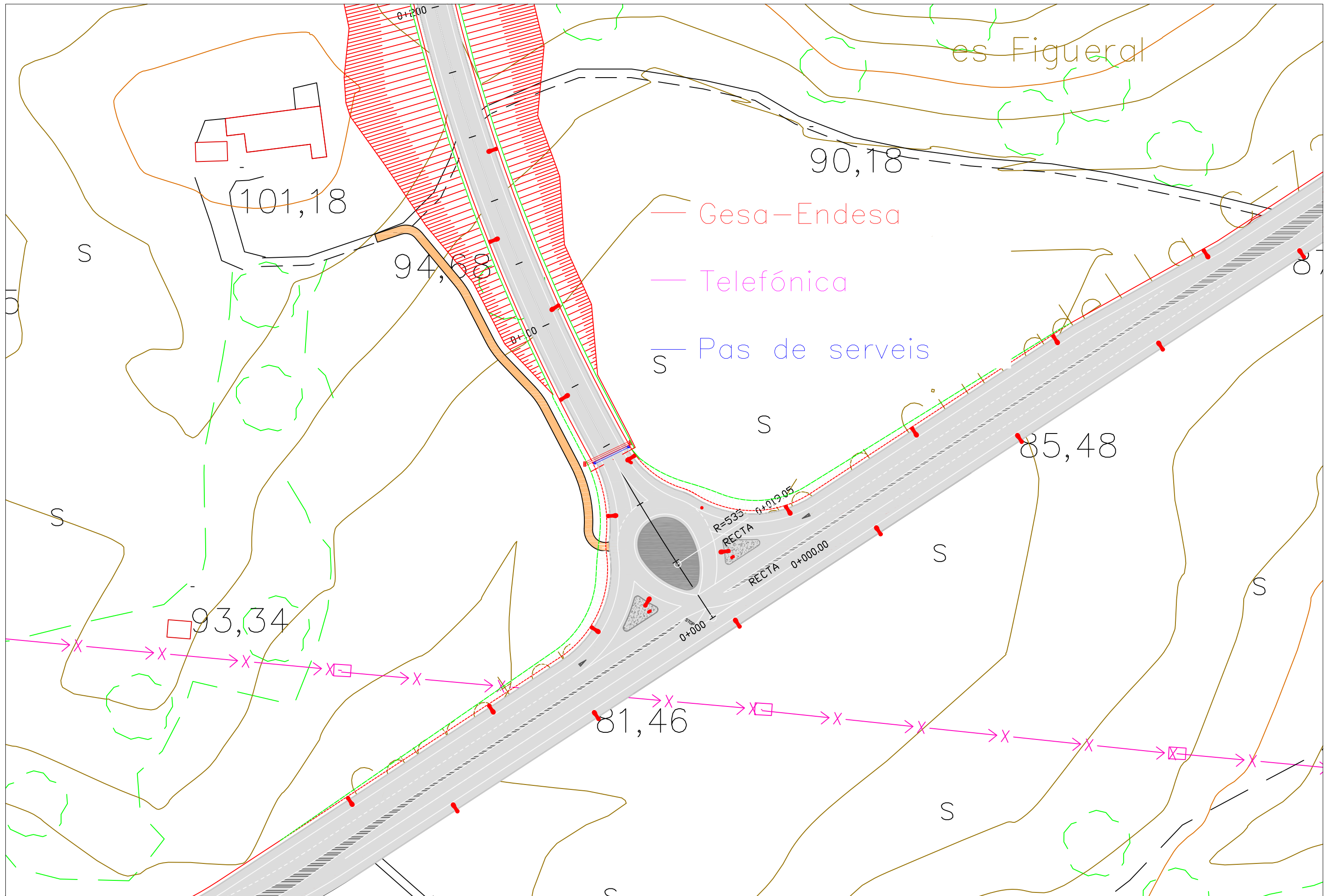

Títol del projecte: Projecte de variant entre la Me-1 i la Me15 al terme municipal de Mercadal (Menorca)	Autor: Pons Florit, Neus	Tutor: Fernandez de Villalta Ferrer-Dalmau, Eduardo	Títol del plànol: Serveis afectats	Escala A3: 1:1000	Plànol núm: 14A 1 de 2 Data: Setembre 2015
---	-----------------------------	--	---------------------------------------	----------------------	---



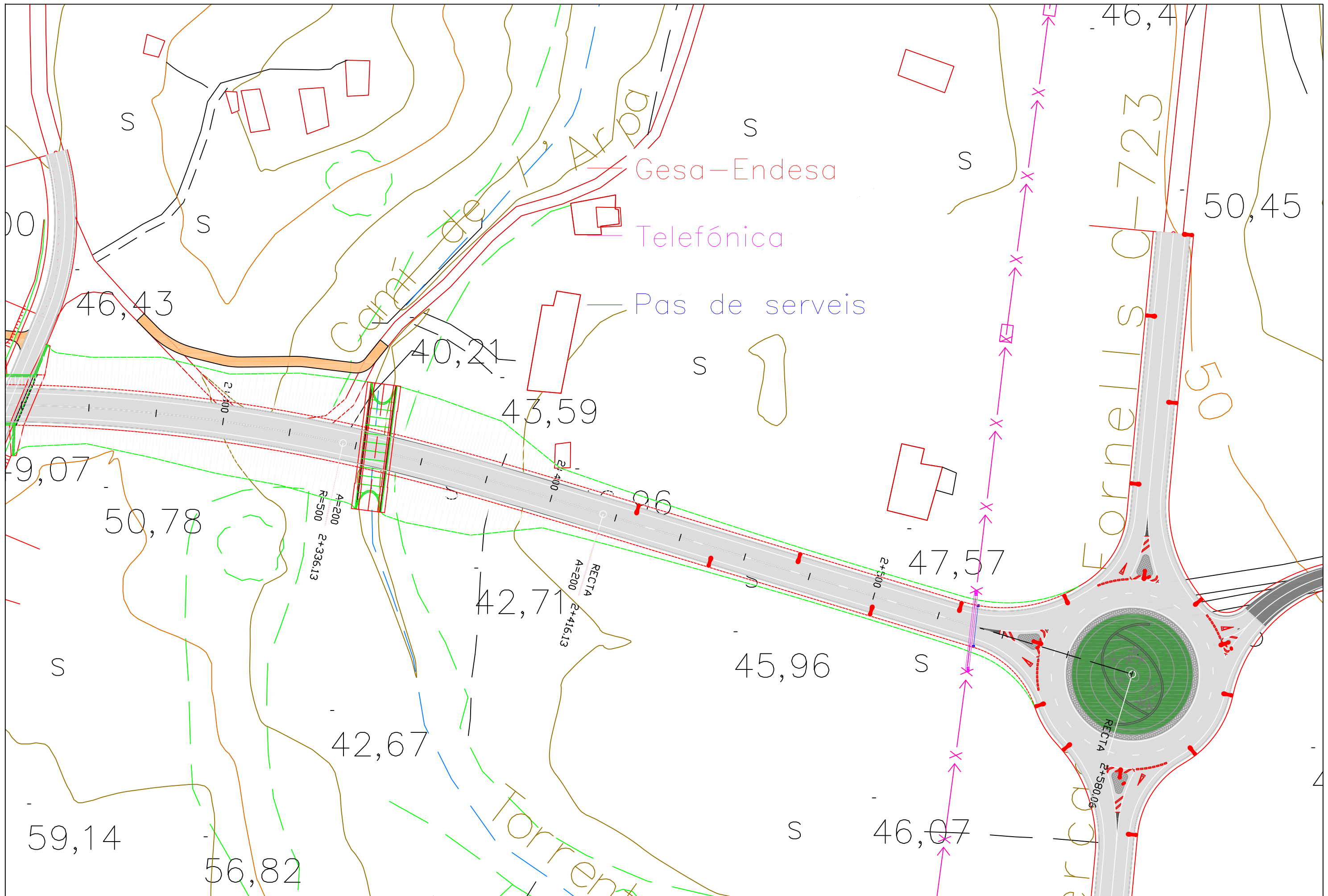

Títol del projecte: Projecte de variant entre la Me-1 i la Me15 al terme municipal de Mercadal (Menorca)	Autor: Pons Florit, Neus	Tutor: Fernandez de Villalta Ferrer-Dalmau, Eduardo	Títol del plànol: Serveis Afectats	Escala A3: 1:1000	Plànol núm: 14A 2 de 2 Data: Setembre 2015
---	-----------------------------	--	---------------------------------------	----------------------	---

**RASA PER A CABLEJAT ENTUBAT  
SOTA VORERA. BAIXA TENSIO**

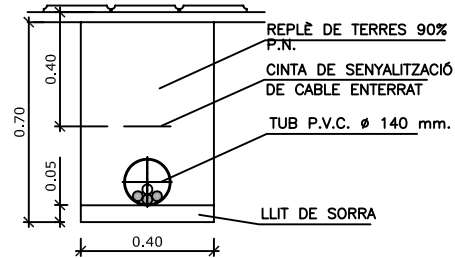

**ARQUETA TIPUS A-1  
BAIXA TENSIO**

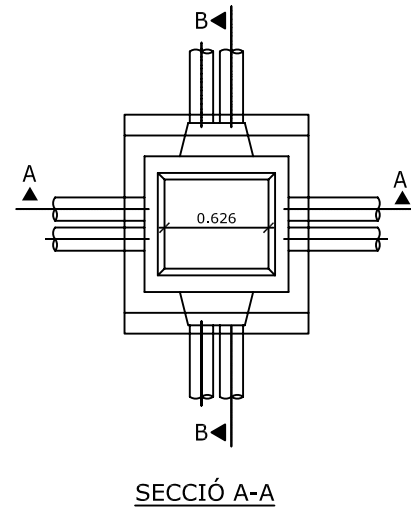

**ARQUETA TIPUS "H"**

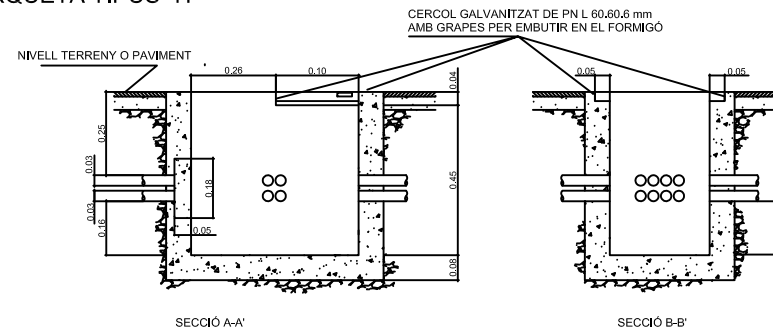

**ARQUETA TIPUS "M"**

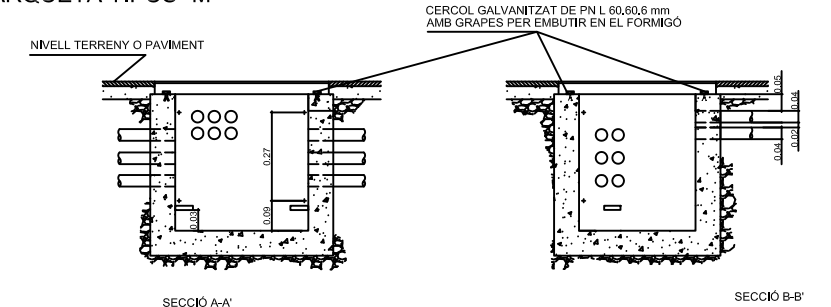

**RASA SOTA CALÇADA  
BAIXA TENSIO**

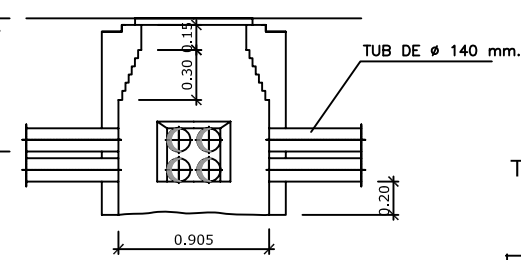
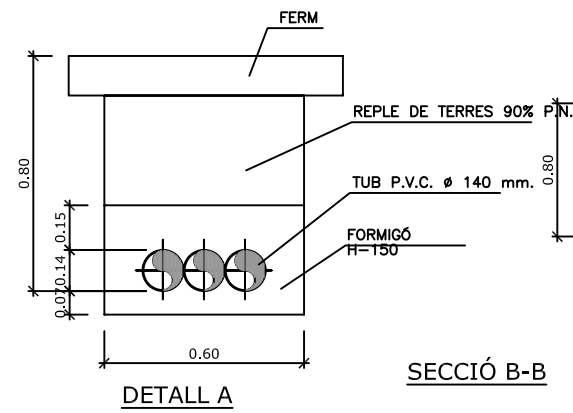

**DETALL A**

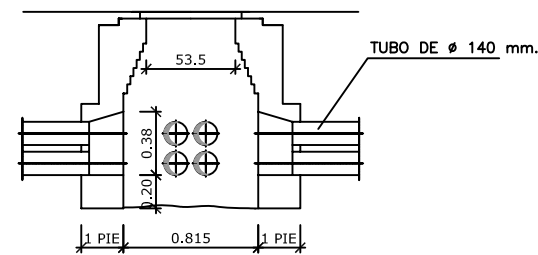

**SECCIÓ B-B**

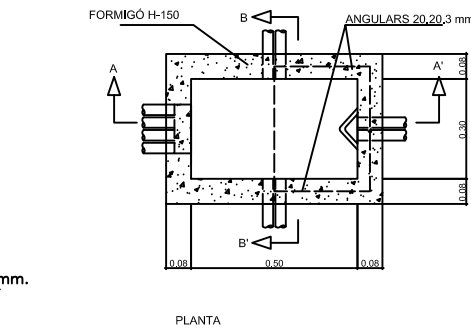

**TAPA ARQUETA TIPUS H**

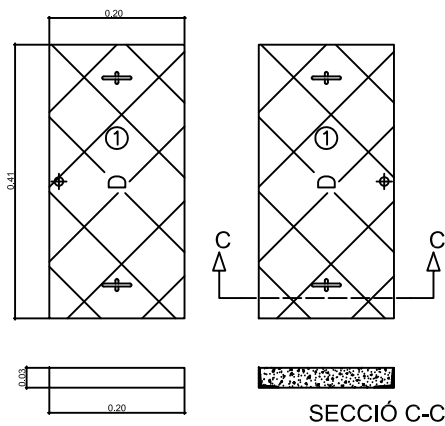

**TAPA ARQUETA TIPUS M**

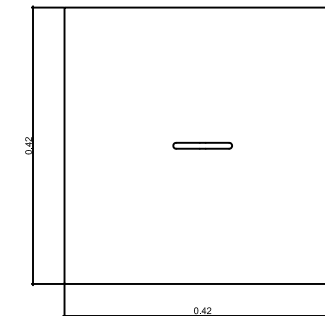
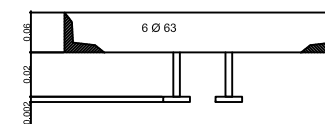

**PRISMES DE CANALITZACIÓ**

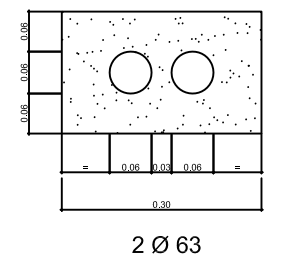
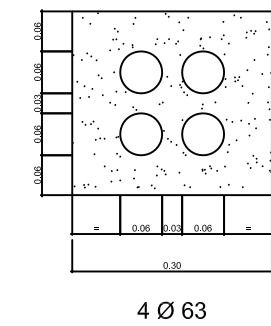

**CANALITZACIÓ AMB TUBS DE PVC**

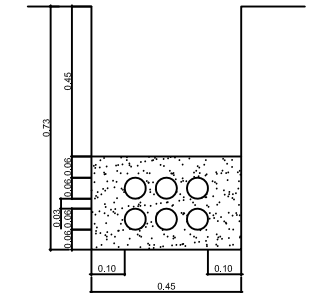

<p>Títol del projecte: Projecte de variant entre la Me-1 i la Me15 al terme municipal de Mercadal (Menorca)</p>	<p>Autor: Pons Florit, Neus</p>	<p>Tutor: Fernandez de Villalta Ferrer-Dalmau, Eduardo</p>	<p>Títol del plànol: Serveis afectats</p>	<p>Escala A3: S/E</p>	<p>Plànol núm: 14B 1 de 1 Data: Setembre 2015</p>
---	-------------------------------------	--	---	---------------------------	---