

Renditzat

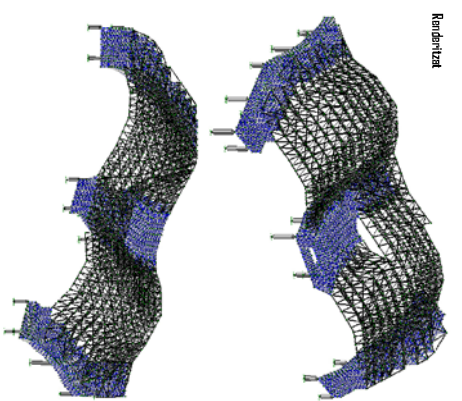

Axils a la coberta

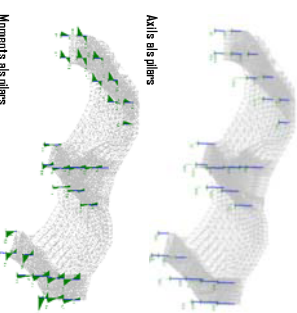

Axils als pilars

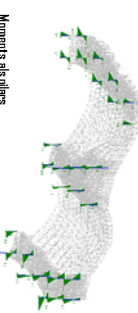

Moments als pilars

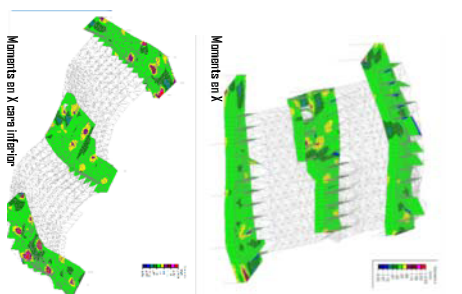

Moments en X

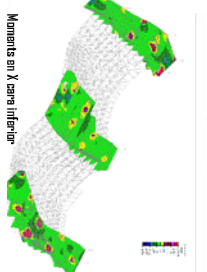

Moments en Y

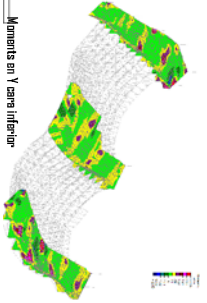

Moments en X cara inferior

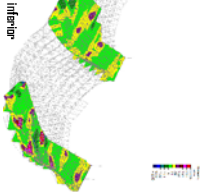

Moments en Y cara inferior

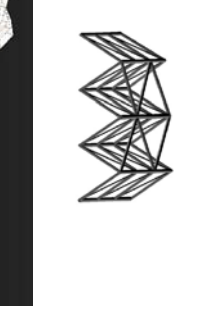
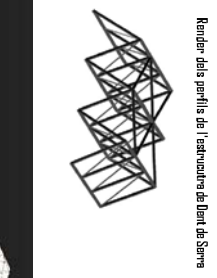
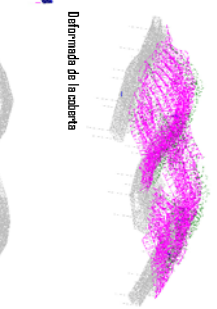
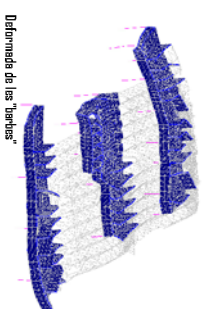
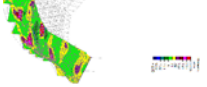

Rendir dels perfils de l'estructura de lunt de Sud

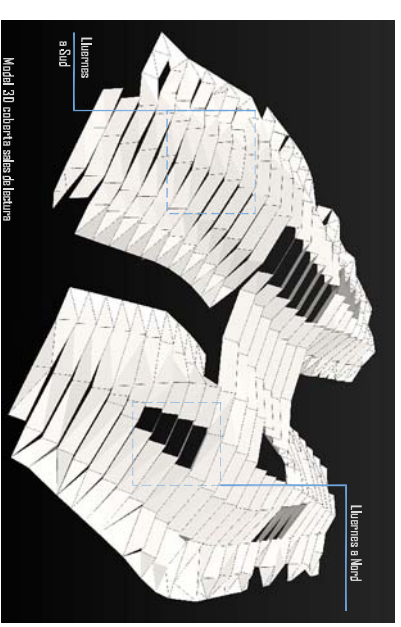

Llisses a Nord

Llisses a Sud

Model 3D coberta s'els solucions

Taula de adreçaments

Tipus	Identificació	Tipus	Tipus	Tipus	Tipus	Tipus	Tipus	Tipus	Tipus
1	1000	1000	1000	1000	1000	1000	1000	1000	1000
2	1000	1000	1000	1000	1000	1000	1000	1000	1000
3	1000	1000	1000	1000	1000	1000	1000	1000	1000
4	1000	1000	1000	1000	1000	1000	1000	1000	1000
5	1000	1000	1000	1000	1000	1000	1000	1000	1000
6	1000	1000	1000	1000	1000	1000	1000	1000	1000
7	1000	1000	1000	1000	1000	1000	1000	1000	1000
8	1000	1000	1000	1000	1000	1000	1000	1000	1000
9	1000	1000	1000	1000	1000	1000	1000	1000	1000
10	1000	1000	1000	1000	1000	1000	1000	1000	1000

DETTALL 1 E 1/20

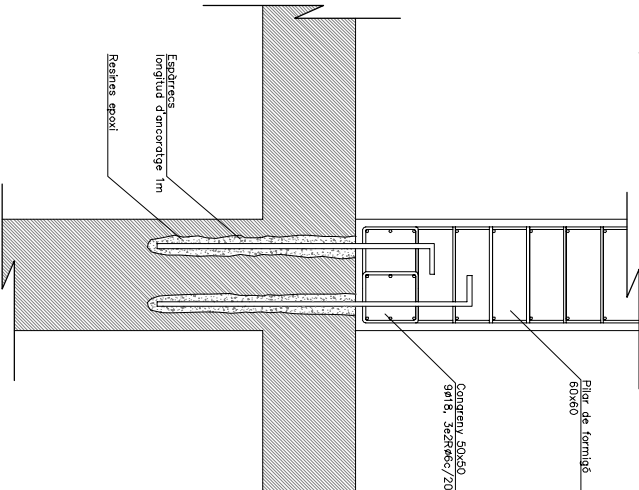

DETTALL 2 E 1/20

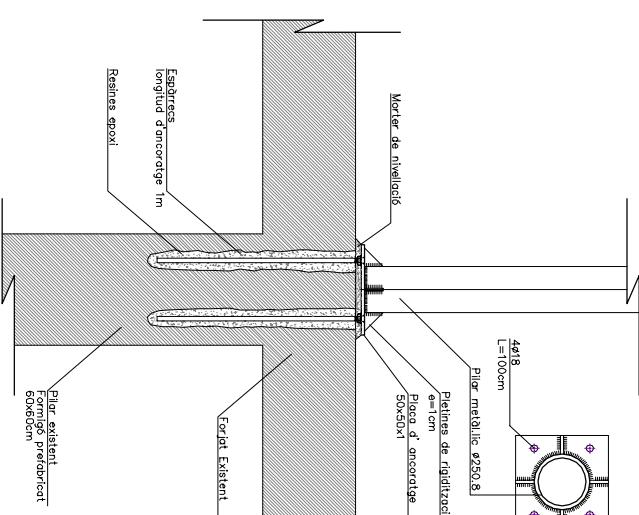

DETTALL ENCAVALADA E 1/20

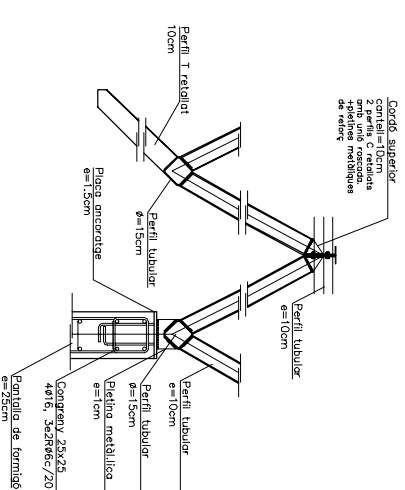

DETTALL CORDÓ SUPERIOR E 1/20



DETTALL CORDÓ INFERIOR E 1/20

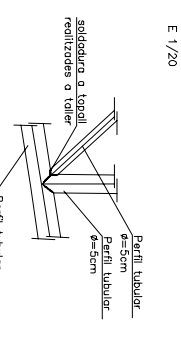

DETTALL BIGA CALAIX E 1/20

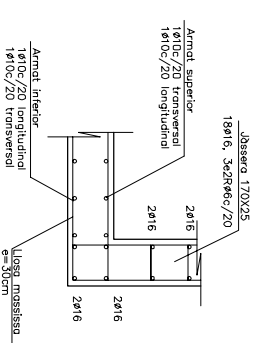

- DESENVOLUPAMENT
- Enginyerament
- Dades, Diagrames
- Plantes
- Seccions
- Figures

SOLUTIONS

- Extençió
- xarxes
- concepte estructural
- definió coberta
- plantes estructura
- Intehibidors

